



# IMB12-04BNSVC0SX01

IMB

INDUCTIVE PROXIMITY SENSORS

**SICK**  
Sensor Intelligence.



### Ordering information

Type	part no.
IMB12-04BNSVCOSX01	1139244

**Included in delivery:** Cable housing/cover (1), BEF-MU-M12N (1)

Other models and accessories → [www.sick.com/IMB](http://www.sick.com/IMB)

Illustration may differ

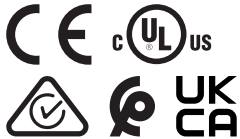

### Detailed technical data

#### Features

<b>Housing</b>	Metric
<b>Housing</b>	Standard design
<b>Thread size</b>	M12 x 1
<b>Diameter</b>	Ø 12 mm
<b>Sensing range <math>S_n</math></b>	4 mm
<b>Safe sensing range <math>S_a</math></b>	3.24 mm
<b>Installation type</b>	Flush
<b>Switching frequency</b>	2,000 Hz
<b>Connection type</b>	Male connector M12, 4-pin <sup>1)</sup>
<b>Switching output</b>	NPN
<b>Switching output detail</b>	NPN
<b>Output function</b>	NO
<b>Electrical wiring</b>	DC 3-wire
<b>Enclosure rating</b>	IP67 <sup>2)</sup>
<b>Special features</b>	Resistant against coolant lubricants, Visual adjustment indicator, ATEX
<b>Special applications</b>	Zones with coolants and lubricants, Mobile machines, Difficult application conditions, Explosive areas
<b>Items supplied</b>	Mounting nut, V2A stainless steel, with locking teeth (2x) Cable housing/cover

<sup>1)</sup> With gold plated contact pins.

<sup>2)</sup> According to EN 60529.

## Mechanics/electronics

<b>Supply voltage</b>	10 V DC ... 30 V DC
<b>Ripple</b>	≤ 10 %
<b>Voltage drop</b>	≤ 2 V <sup>1)</sup>
<b>Hysteresis</b>	3 % ... 20 %
<b>Reproducibility</b>	≤ 2 % <sup>2)</sup> <sup>3)</sup>
<b>Temperature drift (of S<sub>r</sub>)</b>	± 10 %
<b>EMC</b>	According to EN 60947-5-2
<b>Continuous current I<sub>a</sub></b>	≤ 200 mA <sup>4)</sup>
<b>No load current</b>	≤ 10 mA
<b>Short-circuit protection</b>	✓
<b>Power-up pulse protection</b>	✓
<b>Shock and vibration resistance</b>	100 g / 2 ms / 500 cycles; 150 g / 1 Mio cycles; 10 Hz ... 55 Hz / 1 mm; 55 Hz ... 500 Hz / 60 g
<b>Ambient operating temperature</b>	-20 °C ... +85 °C
<b>Housing material</b>	Stainless steel V2A, DIN 1.4305 / AISI 303
<b>Sensing face material</b>	Plastic, LCP
<b>Housing length</b>	65 mm
<b>Thread length</b>	48 mm
<b>Tightening torque, max.</b>	Typ. 20 Nm <sup>5)</sup> Typ. 32 Nm <sup>6)</sup>
<b>ATEX marking</b>	II 3G Ex ec IIC T4 Gc X, II 3D Ex tc IIIC T135 °C Dc X
<b>Ex area category</b>	3G, 3D
<b>Protection class</b>	III
<b>UL File No.</b>	E181493

<sup>1)</sup> At I<sub>a</sub> max.

<sup>2)</sup> Supply voltage U<sub>B</sub> and constant ambient temperature T<sub>a</sub>.

<sup>3)</sup> Of S<sub>r</sub>.

<sup>4)</sup> Depend on ambient temperature. For details see operating instructions under „performance data of the sensor“.

<sup>5)</sup> When using the non-toothed side of the nut.

<sup>6)</sup> Valid if toothed side of nut is used.

## Safety-related parameters

<b>MTTF<sub>D</sub></b>	1,971 years
<b>DC<sub>avg</sub></b>	0 %

## Reduction factors

<b>Note</b>	The values are reference values which may vary
<b>St37 steel (Fe)</b>	1
<b>Stainless steel (V2A, 304)</b>	Approx. 0.65
<b>Aluminum (Al)</b>	Approx. 0.35
<b>Copper (Cu)</b>	Approx. 0.24
<b>Brass (Br)</b>	Approx. 0.38

### Installation note

Remark	Associated graphic see "Installation"
<b>B</b>	12 mm
<b>C</b>	12 mm
<b>D</b>	12 mm
<b>F</b>	32 mm

### Classifications

<b>ECLASS 5.0</b>	27270101
<b>ECLASS 5.1.4</b>	27270101
<b>ECLASS 6.0</b>	27270101
<b>ECLASS 6.2</b>	27270101
<b>ECLASS 7.0</b>	27270101
<b>ECLASS 8.0</b>	27270101
<b>ECLASS 8.1</b>	27270101
<b>ECLASS 9.0</b>	27270101
<b>ECLASS 10.0</b>	27270101
<b>ECLASS 11.0</b>	27270101
<b>ECLASS 12.0</b>	27274001
<b>ETIM 5.0</b>	EC002714
<b>ETIM 6.0</b>	EC002714
<b>ETIM 7.0</b>	EC002714
<b>ETIM 8.0</b>	EC002714
<b>UNSPSC 16.0901</b>	39122230

### Certificates

<b>EU declaration of conformity</b>	✓
<b>UK declaration of conformity</b>	✓
<b>ACMA declaration of conformity</b>	✓
<b>Moroccan declaration of conformity</b>	✓
<b>China RoHS</b>	✓
<b>cULus certificate</b>	✓

### Installation note Flush installation

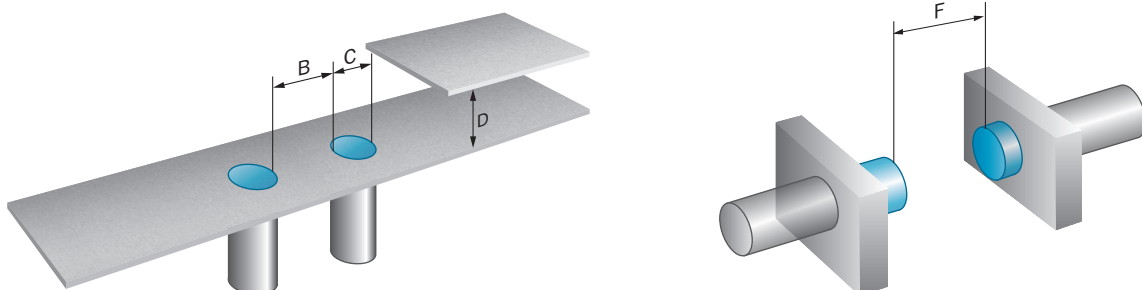

### Connection diagram Cd-007

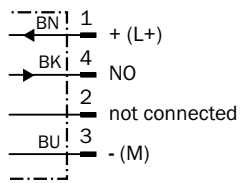

### Response diagram

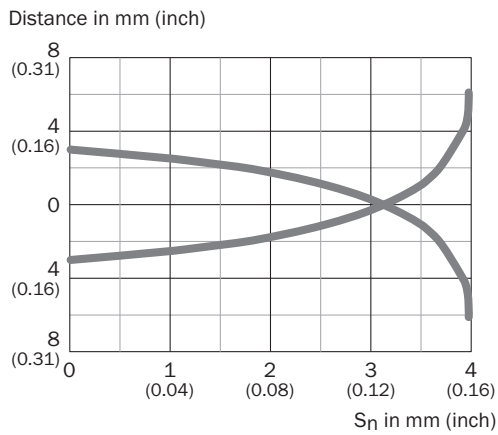

### Functional principle Installation aid

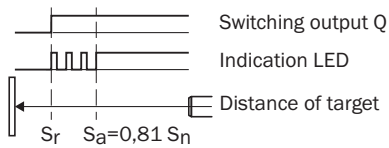

### Dimensional drawing IMB12 Standard, connector, M12, flush

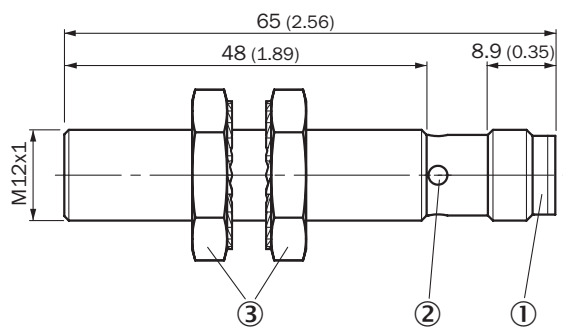





Dimensions in mm (inch)

- ① Connection
- ② Display LED
- ③ Fastening nuts (2 x); width across 17, stainless steel V2A

### Recommended accessories

Other models and accessories → [www.sick.com/IMB](http://www.sick.com/IMB)

	Brief description	Type	part no.
Mounting systems			
	<ul style="list-style-type: none"> <li>• <b>Description:</b> Mounting plate for M12 sensors</li> <li>• <b>Material:</b> Stainless steel</li> <li>• <b>Details:</b> Stainless steel</li> <li>• <b>Items supplied:</b> Without mounting hardware</li> </ul>	BEF-WG-M12N	5320950
	<ul style="list-style-type: none"> <li>• <b>Description:</b> Mounting bracket for M12 sensors</li> <li>• <b>Material:</b> Steel</li> <li>• <b>Details:</b> Steel, zinc coated</li> <li>• <b>Items supplied:</b> Without mounting hardware</li> </ul>	BEF-WN-M12	5308447
	<ul style="list-style-type: none"> <li>• <b>Description:</b> Mounting bracket for M12 housing</li> <li>• <b>Material:</b> Stainless steel</li> <li>• <b>Details:</b> Stainless steel</li> <li>• <b>Items supplied:</b> Without mounting hardware</li> </ul>	BEF-WN-M12N	5320949
	<ul style="list-style-type: none"> <li>• <b>Description:</b> Plate N05N for universal clamp bracket, M12</li> <li>• <b>Material:</b> Stainless steel, stainless steel</li> <li>• <b>Details:</b> Stainless steel 1.4571 (sheet), Stainless steel 1.4408 (clamp)</li> <li>• <b>Items supplied:</b> Universal clamp (5322627), mounting hardware</li> <li>• <b>Usable for:</b> IMA, IMF, M12 round sensors, UC4, V12-2, MultiV, MultiLine, W4-3, MultiV, MultiLine</li> </ul>	BEF-KHS-N05N	2051621

	Brief description	Type	part no.
connectors and cables			
	<ul style="list-style-type: none"> <li>• <b>Connection type head A:</b> Female connector, M12, 4-pin, straight</li> <li>• <b>Connection type head B:</b> Flying leads</li> <li>• <b>Signal type:</b> Sensor/actuator cable</li> <li>• <b>Cable:</b> 2 m, 4-wire, PP</li> <li>• <b>Description:</b> Sensor/actuator cable, unshielded</li> <li>• <b>Connection systems:</b> Flying leads</li> <li>• <b>Note:</b> This product is generally resistant to chemical cleaning agents (see ECOLAB) and other chemical compounds such as H2O2 and CH2O2. Before permanent installation is carried out, the material's resistance to the cleaning agent being used must be checked., Resistant against lactic acid &amp; hydrogen peroxide (H2O2)</li> <li>• <b>Application:</b> Hygienic and washdown zones, Drag chain operation, Robot, cold bending resistant, seawater resistant</li> </ul>	DOL-1204-G02MRN	6058291
	<ul style="list-style-type: none"> <li>• <b>Connection type head A:</b> Female connector, M12, 4-pin, straight</li> <li>• <b>Connection type head B:</b> Flying leads</li> <li>• <b>Signal type:</b> Sensor/actuator cable</li> <li>• <b>Cable:</b> 5 m, 4-wire, PP</li> <li>• <b>Description:</b> Sensor/actuator cable, unshielded</li> <li>• <b>Connection systems:</b> Flying leads</li> <li>• <b>Note:</b> This product is generally resistant to chemical cleaning agents (see ECOLAB) and other chemical compounds such as H2O2 and CH2O2. Before permanent installation is carried out, the material's resistance to the cleaning agent being used must be checked., Resistant against lactic acid &amp; hydrogen peroxide (H2O2)</li> <li>• <b>Application:</b> Hygienic and washdown zones, Drag chain operation, Robot, cold bending resistant, seawater resistant</li> </ul>	DOL-1204-G05MRN	6058476
	<ul style="list-style-type: none"> <li>• <b>Connection type head A:</b> Female connector, M12, 4-pin, angled</li> <li>• <b>Connection type head B:</b> Flying leads</li> <li>• <b>Signal type:</b> Sensor/actuator cable</li> <li>• <b>Cable:</b> 2 m, 4-wire, PP</li> <li>• <b>Description:</b> Sensor/actuator cable, unshielded</li> <li>• <b>Connection systems:</b> Flying leads</li> <li>• <b>Note:</b> This product is generally resistant to chemical cleaning agents (see ECOLAB) and other chemical compounds such as H2O2 and CH2O2. Before permanent installation is carried out, the material's resistance to the cleaning agent being used must be checked., Resistant against lactic acid &amp; hydrogen peroxide (H2O2)</li> <li>• <b>Application:</b> Hygienic and washdown zones, Drag chain operation, Robot, cold bending resistant, seawater resistant</li> </ul>	DOL-1204-W02MRN	6058474
	<ul style="list-style-type: none"> <li>• <b>Connection type head A:</b> Female connector, M12, 4-pin, angled</li> <li>• <b>Connection type head B:</b> Flying leads</li> <li>• <b>Signal type:</b> Sensor/actuator cable</li> <li>• <b>Cable:</b> 5 m, 4-wire, PP</li> <li>• <b>Description:</b> Sensor/actuator cable, unshielded</li> <li>• <b>Connection systems:</b> Flying leads</li> <li>• <b>Note:</b> This product is generally resistant to chemical cleaning agents (see ECOLAB) and other chemical compounds such as H2O2 and CH2O2. Before permanent installation is carried out, the material's resistance to the cleaning agent being used must be checked., Resistant against lactic acid &amp; hydrogen peroxide (H2O2)</li> <li>• <b>Application:</b> Hygienic and washdown zones, Drag chain operation, Robot, cold bending resistant, seawater resistant</li> </ul>	DOL-1204-W05MRN	6058477
	<ul style="list-style-type: none"> <li>• <b>Connection type head A:</b> Female connector, M12, 4-pin, angled</li> <li>• <b>Connection type head B:</b> Flying leads</li> <li>• <b>Signal type:</b> Sensor/actuator cable</li> <li>• <b>Cable:</b> 2 m, 4-wire, PP</li> <li>• <b>Description:</b> Sensor/actuator cable, unshielded</li> <li>• <b>Connection systems:</b> Flying leads</li> <li>• <b>Note:</b> This product is generally resistant to chemical cleaning agents (see ECOLAB) and other chemical compounds such as H2O2 and CH2O2. Before permanent installation is carried out, the material's resistance to the cleaning agent being used must be checked., Resistant against lactic acid &amp; hydrogen peroxide (H2O2), only suitable for PNP sensors</li> <li>• <b>Application:</b> Hygienic and washdown zones, Drag chain operation, Robot, cold bending resistant, seawater resistant</li> </ul>	DOL-1204-L02MRN	6058482
	<ul style="list-style-type: none"> <li>• <b>Connection type head A:</b> Female connector, M12, 4-pin, angled</li> <li>• <b>Connection type head B:</b> Flying leads</li> <li>• <b>Signal type:</b> Sensor/actuator cable</li> <li>• <b>Cable:</b> 5 m, 4-wire, PP</li> <li>• <b>Description:</b> Sensor/actuator cable, unshielded</li> <li>• <b>Connection systems:</b> Flying leads</li> <li>• <b>Note:</b> This product is generally resistant to chemical cleaning agents (see ECOLAB) and other chemical compounds such as H2O2 and CH2O2. Before permanent installation is carried out, the material's resistance to the cleaning agent being used must be checked., Resistant against lactic acid &amp; hydrogen peroxide (H2O2), only suitable for PNP sensors</li> </ul>	DOL-1204-L05MRN	6058483

	Brief description	Type	part no.
	<ul style="list-style-type: none"> <li><b>Application:</b> Hygienic and washdown zones, Drag chain operation, Robot, cold bending resistant, seawater resistant</li> </ul>		
	<ul style="list-style-type: none"> <li><b>Connection type head A:</b> Female connector, M12, 4-pin, angled</li> <li><b>Connection type head B:</b> Male connector, M12, 4-pin, straight</li> <li><b>Signal type:</b> Sensor/actuator cable</li> <li><b>Cable:</b> 2 m, 4-wire, PP</li> <li><b>Description:</b> Sensor/actuator cable, unshielded</li> <li><b>Note:</b> This product is generally resistant to chemical cleaning agents (see ECOLAB) and other chemical compounds such as H2O2 and CH2O2. Before permanent installation is carried out, the material's resistance to the cleaning agent being used must be checked., Resistant against lactic acid &amp; hydrogen peroxide (H2O2)</li> <li><b>Application:</b> Hygienic and washdown zones, Drag chain operation, Robot, cold bending resistant, seawater resistant</li> </ul>	DSL-1204-B02MRN	6058502
	<ul style="list-style-type: none"> <li><b>Connection type head A:</b> Female connector, M12, 4-pin, angled</li> <li><b>Connection type head B:</b> Male connector, M12, 4-pin, straight</li> <li><b>Signal type:</b> Sensor/actuator cable</li> <li><b>Cable:</b> 5 m, 4-wire, PP</li> <li><b>Description:</b> Sensor/actuator cable, unshielded</li> <li><b>Note:</b> This product is generally resistant to chemical cleaning agents (see ECOLAB) and other chemical compounds such as H2O2 and CH2O2. Before permanent installation is carried out, the material's resistance to the cleaning agent being used must be checked., Resistant against lactic acid &amp; hydrogen peroxide (H2O2)</li> <li><b>Application:</b> Hygienic and washdown zones, Drag chain operation, Robot, cold bending resistant, seawater resistant</li> </ul>	DSL-1204-B05MRN	6058503
	<ul style="list-style-type: none"> <li><b>Connection type head A:</b> Female connector, M12, 4-pin, straight</li> <li><b>Connection type head B:</b> Male connector, M12, 4-pin, straight</li> <li><b>Signal type:</b> Sensor/actuator cable</li> <li><b>Cable:</b> 2 m, 4-wire, PP</li> <li><b>Description:</b> Sensor/actuator cable, unshielded</li> <li><b>Note:</b> This product is generally resistant to chemical cleaning agents (see ECOLAB) and other chemical compounds such as H2O2 and CH2O2. Before permanent installation is carried out, the material's resistance to the cleaning agent being used must be checked., Resistant against lactic acid &amp; hydrogen peroxide (H2O2)</li> <li><b>Application:</b> Hygienic and washdown zones, Drag chain operation, Robot, cold bending resistant, seawater resistant</li> </ul>	DSL-1204-G02MRN	6058499
	<ul style="list-style-type: none"> <li><b>Connection type head A:</b> Female connector, M12, 4-pin, straight</li> <li><b>Connection type head B:</b> Male connector, M12, 4-pin, straight</li> <li><b>Signal type:</b> Sensor/actuator cable</li> <li><b>Cable:</b> 5 m, 4-wire, PP</li> <li><b>Description:</b> Sensor/actuator cable, unshielded</li> <li><b>Note:</b> This product is generally resistant to chemical cleaning agents (see ECOLAB) and other chemical compounds such as H2O2 and CH2O2. Before permanent installation is carried out, the material's resistance to the cleaning agent being used must be checked., Resistant against lactic acid &amp; hydrogen peroxide (H2O2)</li> <li><b>Application:</b> Hygienic and washdown zones, Drag chain operation, Robot, cold bending resistant, seawater resistant</li> </ul>	DSL-1204-G05MRN	6058500
	<ul style="list-style-type: none"> <li><b>Connection type head A:</b> Female connector, M12, 4-pin, straight, A-coded</li> <li><b>Connection type head B:</b> Flying leads</li> <li><b>Signal type:</b> Sensor/actuator cable</li> <li><b>Cable:</b> 5 m, 4-wire, PUR, halogen-free</li> <li><b>Description:</b> Sensor/actuator cable, unshielded</li> <li><b>Application:</b> Drag chain operation, Zones with oils and lubricants, Robot, Drag chain operation</li> </ul>	YF2A14-050UB3XLEAX	2095608
	<ul style="list-style-type: none"> <li><b>Connection type head A:</b> Female connector, M12, 4-pin, straight</li> <li><b>Connection type head B:</b> Male connector, M12, 4-pin, straight</li> <li><b>Signal type:</b> Sensor/actuator cable</li> <li><b>Cable:</b> 20 m, 4-wire, PP</li> <li><b>Description:</b> Sensor/actuator cable, unshielded</li> <li><b>Note:</b> This product is generally resistant to chemical cleaning agents (see ECOLAB) and other chemical compounds such as H2O2 and CH2O2. Before permanent installation is carried out, the material's resistance to the cleaning agent being used must be checked., Resistant against lactic acid &amp; hydrogen peroxide (H2O2)</li> <li><b>Application:</b> Hygienic and washdown zones, Drag chain operation, Robot, cold bending resistant, seawater resistant</li> </ul>	YF2AP4-020PA2M2AP4	2143765
	<ul style="list-style-type: none"> <li><b>Connection type head A:</b> Female connector, M12, 4-pin, straight, A-coded</li> <li><b>Connection type head B:</b> Flying leads</li> <li><b>Signal type:</b> Sensor/actuator cable</li> <li><b>Cable:</b> 5 m, 4-wire, PVC</li> <li><b>Description:</b> Sensor/actuator cable, unshielded</li> <li><b>Application:</b> Uncontaminated zones, Zones with chemicals</li> </ul>	YF2A14-050VB3XLEAX	2096235
	<ul style="list-style-type: none"> <li><b>Connection type head A:</b> Female connector, M12, 4-pin, angled</li> <li><b>Connection type head B:</b> Male connector, M12, 4-pin, straight</li> <li><b>Signal type:</b> Sensor/actuator cable</li> </ul>	YG2AP4-030PA2M2AP4	2151191

	Brief description	Type	part no.
	<ul style="list-style-type: none"> <li>• <b>Cable:</b> 3 m, 4-wire, PP</li> <li>• <b>Description:</b> Sensor/actuator cable, unshielded</li> <li>• <b>Note:</b> This product is generally resistant to chemical cleaning agents (see ECOLAB) and other chemical compounds such as H2O2 and CH2O2. Before permanent installation is carried out, the material's resistance to the cleaning agent being used must be checked., Resistant against lactic acid &amp; hydrogen peroxide (H2O2)</li> <li>• <b>Application:</b> Hygienic and washdown zones, Drag chain operation</li> </ul>		
device protection and care			
	<ul style="list-style-type: none"> <li>• <b>Description:</b> Screw-on protective cap for metric sensors. Protects the sensor from damage caused by impacts on the front.</li> <li>• <b>Material:</b> Plastic</li> <li>• <b>Usable for:</b> M12 size metric sensors, For flush mounting</li> </ul>	CAP-M12-TB	2083430

## SICK AT A GLANCE

SICK is one of the leading manufacturers of intelligent sensors and sensor solutions for industrial applications. A unique range of products and services creates the perfect basis for controlling processes securely and efficiently, protecting individuals from accidents and preventing damage to the environment.

We have extensive experience in a wide range of industries and understand their processes and requirements. With intelligent sensors, we can deliver exactly what our customers need. In application centers in Europe, Asia and North America, system solutions are tested and optimized in accordance with customer specifications. All this makes us a reliable supplier and development partner.

Comprehensive services complete our offering: SICK LifeTime Services provide support throughout the machine life cycle and ensure safety and productivity.

For us, that is “Sensor Intelligence.”

## WORLDWIDE PRESENCE:

Contacts and other locations –[www.sick.com](http://www.sick.com)