



# RSB1-0920G128076KH3GZZZZZZ

Roller Sensor Bar

PHOTOELECTRIC SENSORS

**SICK**  
Sensor Intelligence.



Illustration may differ



### Ordering information

Type	part no.
RSB1-0920G128076KH3GZZZZZ	1139200

Other models and accessories → [www.sick.com/Roller\\_Sensor\\_Bar](http://www.sick.com/Roller_Sensor_Bar)

### Detailed technical data

#### Features

<b>Functional principle</b>	Photoelectric proximity sensor
<b>Functional principle detail</b>	Energetic
<b>Sensing range</b>	
Sensing range min.	2 mm
Sensing range max.	300 mm
Reference object	Object with 90% remission factor (complies with standard white according to DIN 5033)
Recommended sensing range for the best performance	2 mm ... 45 mm
<b>Emitted beam</b>	
Light source	LED
Type of light	Infrared light
Shape of light spot	Point-shaped
Light spot size (distance)	27 mm x 29 mm (45 mm)
Maximum dispersion of the emitted beam around the standardized transmission axis (squint angle)	< +/- 4° (at T <sub>a</sub> = +23 °C)
<b>Key LED figures</b>	
LED risk group marking	Free group
Wave length	850 nm
Average service life	100,000 h at T <sub>a</sub> = +25 °C
<b>Number of beams</b>	7
<b>Beam separation</b>	128 mm
<b>Distance from 1st beam to leading edge of housing (including end cap)</b>	76 mm
<b>Smallest detectable object (MDO) typ.</b>	
	128 mm, Dependent on distance between beams
<b>Adjustment</b>	
None	-
<b>Display</b>	

	LED green	Operating indicator Static on: power on
	LED yellow	Status of received light beam Static on: object present Static off: object not present
<b>Special applications</b>		Detecting flat objects, Detecting perforated objects, Detecting objects with position tolerances, Detecting uneven, shiny objects

## Electronics

<b>Supply voltage <math>U_B</math></b>		10 V DC ... 30 V DC
<b>Ripple</b>		$\leq 5 V_{pp}$
<b>Usage category</b>		DC-12 (According to EN 60947-5-2) DC-13 (According to EN 60947-5-2)
<b>Current consumption</b>		32 mA, without load. At $U_B = 24 V$
<b>Protection class</b>		III
<b>Digital output</b>		
	Number	1
	Type	PNP: open collector
	Switching mode	Light/dark switching
	Signal voltage PNP HIGH/LOW	Approx. $U_B - 2.5 V / 0 V$
	Output current $I_{max}$	$\leq 100 mA$
	Circuit protection outputs	Reverse polarity protected Overcurrent protected Short-circuit protected
	Response time	$\leq 1 ms^1$
	Repeatability (response time)	1 ms
	Switching frequency	500 Hz <sup>2)</sup>
<b>Pin/Wire assignment</b>		
	BN 1	+ (L+)
	WH 2	$Q_2$
	BU 3	- (M)
	BK 4	$Q_1$
	Function of pin 4/black (BK)	Digital output, dark switching, object present → output LOW
	Function of pin 2/white (WH)	Digital output, light switching, object present → output HIGH

<sup>1)</sup> Signal transit time with resistive load.

<sup>2)</sup> With light/dark ratio 1:1.

## Mechanics

<b>Dimensions (W x H x D)</b>		920 mm x 20.3 mm x 17 mm <sup>1)</sup>
<b>Connection</b>		Cable with connector M8, 4-pin, with knurled nut <sup>2)</sup>
<b>Connection detail</b>		
	Deep-freeze property	Do not bend below 0 °C
	Conductor size	0.13 mm <sup>2</sup>

<sup>1)</sup> W = length of Roller Sensor Bar (in the installed state).

<sup>2)</sup> Due to the manufacturing process, the cable can be a little longer.

	Cable diameter	Ø 3.6 mm
	Length of cable (L)	2 m <sup>2)</sup>
<b>Material</b>	Housing	Metal, Aluminum (anodised)
	Front screen	Plastic, PMMA
	Cable	Plastic, PVC
	Male connector	Plastic, PVC
<b>Weight</b>		Approx. 333.8 g
<b>Mounting system type</b>		None

<sup>1)</sup> W = length of Roller Sensor Bar (in the installed state).

<sup>2)</sup> Due to the manufacturing process, the cable can be a little longer.

### Ambient data

<b>Enclosure rating</b>	IP67 (EN 60529)
<b>Ambient operating temperature</b>	-40 °C ... +60 °C
<b>Ambient temperature, storage</b>	-40 °C ... +75 °C
<b>Shock resistance</b>	30 g, 11 ms (3 positive and 3 negative shocks along X, Y, Z axes, 18 total shocks (EN60068-2-27))
<b>Vibration resistance</b>	10 Hz ... 55 Hz (Amplitude 1 mm, 3 x 30 min (EN60068-2-6))
<b>Air humidity</b>	15 % ... 95 %, relative humidity (no condensation), as per IEC 60947-5-2
<b>Electromagnetic compatibility (EMC)</b>	EN 60947-5-2
<b>UL File No.</b>	NRKH.E189383 & NRKH7.E189383

### Certificates

<b>EU declaration of conformity</b>	✓
<b>UK declaration of conformity</b>	✓
<b>ACMA declaration of conformity</b>	✓
<b>China RoHS</b>	✓
<b>cULus certificate</b>	✓

### Classifications

<b>ECLASS 5.0</b>	27270904
<b>ECLASS 5.1.4</b>	27270904
<b>ECLASS 6.0</b>	27270904
<b>ECLASS 6.2</b>	27270904
<b>ECLASS 7.0</b>	27270904
<b>ECLASS 8.0</b>	27270904
<b>ECLASS 8.1</b>	27270904
<b>ECLASS 9.0</b>	27270904
<b>ECLASS 10.0</b>	27270904
<b>ECLASS 11.0</b>	27270904
<b>ECLASS 12.0</b>	27270903
<b>ETIM 5.0</b>	EC002719
<b>ETIM 6.0</b>	EC002719

<b>ETIM 7.0</b>	EC002719
<b>ETIM 8.0</b>	EC002719
<b>UNSPSC 16.0901</b>	39121528

Dimensional drawing



Dimensions in mm (inch)

- ① Distance from 1st beam to leading edge of housing (including end cap)
- ② Beam separation
- ③ length of Roller Sensor Bar (in the installed state)
- ④ display and adjustment elements
- ⑤ First beam (number of beams varies depending on the variant)
- ⑥ Spring loaded end cap (for further information see the installation note)
- ⑦ Connection

display and adjustment elements

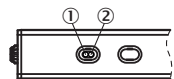

- ① LED green
- ② LED yellow

Installation note

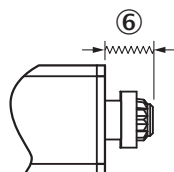

⑥ Range of motion of the spring loaded end cap (up to 5 mm of compression in uninstalled state)

Connection type Male connector M8, 4-pin



### Characteristic curve

Operating reserve



Recommended sensing range for the best performance

- ① Black object, 6% remission factor
- ② Gray object, 18% remission factor
- ③ White object, 90% remission factor

### Light spot size

Dimensions in mm (inch)



Recommended sensing range for the best performance

### Light spot size

mm (inch)



- ① Black object, 6% remission factor
- ② Gray object, 18% remission factor
- ③ White object, 90% remission factor

### Recommended accessories

Other models and accessories → [www.sick.com/Roller\\_Sensor\\_Bar](http://www.sick.com/Roller_Sensor_Bar)

	Brief description	Type	part no.
<b>Mounting systems</b>			
	<ul style="list-style-type: none"> <li><b>Description:</b> 8 mm round adapter bracket with adhesive back</li> </ul>	BEF-AP-RSBADHA	2127765
	<ul style="list-style-type: none"> <li><b>Description:</b> Adapter bracket with adhesive back</li> </ul>	BEF-AP-RSBADHB	2127766
	<ul style="list-style-type: none"> <li><b>Description:</b> Adapter bracket to snap between hex sections</li> </ul>	BEF-AP-RSBCON	2127768
	<ul style="list-style-type: none"> <li><b>Description:</b> Hex adapter bracket</li> </ul>	BEF-AP-RSBHEX	2127767
	<ul style="list-style-type: none"> <li><b>Description:</b> Adapter kit: BEF-AP-RSBADHA, BEF-AP-RSBADHB, BEF-AP-RSBCON, BEF-AP-RSBHEX</li> <li><b>Items supplied:</b> BEF-AP-RSBADHA, BEF-AP-RSBADHB, BEF-AP-RSBCON, BEF-AP-RSBHEX</li> </ul>	BEF-AP-RSBKIT	2127759
<b>connectors and cables</b>			
	<ul style="list-style-type: none"> <li><b>Description:</b> Unshielded</li> <li><b>Connection type head A:</b> Male connector, M8, 4-pin, straight, A-coded</li> <li><b>Connection systems:</b> Screw-type terminals</li> <li><b>Permitted cross-section:</b> 0.14 mm<sup>2</sup> ... 0.5 mm<sup>2</sup></li> </ul>	STE-0804-G	6037323
	<ul style="list-style-type: none"> <li><b>Description:</b> Sensor/actuator cable, unshielded</li> <li><b>Connection type head A:</b> Female connector, M8, 4-pin, straight, A-coded</li> <li><b>Connection type head B:</b> Flying leads</li> <li><b>Signal type:</b> Sensor/actuator cable</li> <li><b>Cable:</b> 5 m, 4-wire, PUR, halogen-free</li> <li><b>Application:</b> Drag chain operation, Zones with oils and lubricants, Robot, Drag chain operation</li> </ul>	YF8U14-050UA3XLEAX	2094792
	<ul style="list-style-type: none"> <li><b>Description:</b> Sensor/actuator cable, unshielded</li> <li><b>Connection type head A:</b> Female connector, M8, 4-pin, straight, A-coded</li> <li><b>Connection type head B:</b> Flying leads</li> <li><b>Signal type:</b> Sensor/actuator cable</li> <li><b>Cable:</b> 5 m, 4-wire, PVC</li> <li><b>Application:</b> Uncontaminated zones, Zones with chemicals</li> </ul>	YF8U14-050VA3XLEAX	2095889

## SICK AT A GLANCE

SICK is one of the leading manufacturers of intelligent sensors and sensor solutions for industrial applications. A unique range of products and services creates the perfect basis for controlling processes securely and efficiently, protecting individuals from accidents and preventing damage to the environment.

We have extensive experience in a wide range of industries and understand their processes and requirements. With intelligent sensors, we can deliver exactly what our customers need. In application centers in Europe, Asia and North America, system solutions are tested and optimized in accordance with customer specifications. All this makes us a reliable supplier and development partner.

Comprehensive services complete our offering: SICK LifeTime Services provide support throughout the machine life cycle and ensure safety and productivity.

For us, that is “Sensor Intelligence.”

## WORLDWIDE PRESENCE:

Contacts and other locations –[www.sick.com](http://www.sick.com)