



PM4-A237110000000

Mirror

REFLECTORS AND OPTICS

SICK
Sensor Intelligence.



Ordering information

Type	part no.
PM4-A23711000000	1138920

Other models and accessories → www.sick.com/Mirror

Detailed technical data

Features

Description	PM4 mirror column with fixed mirror for beam deflection. Allows multi-sided access protection.
Mounting system type	Mechanical anchoring to the floor
Items supplied	PM4 mirror column with pre-assembled alignment plate and removable end cap Base plate with spirit level, fine alignment wheel and setscrews M8 screws and washers for mounting the alignment plate on the base plate Operating instructions for download
Column height	2,374.5 mm
Mirror height	2,213 mm
Mirror width	125 mm
Suitable for device variants	
deTec safety light curtain	Protective field height ≤ 2,100 mm
deTem safety light-beam sensor	Any
Suitable for	Safety light curtains Safety light-beam sensors
Type of diversion	Horizontal

Functions

Alignment	The complete alignment process involves leveling the base plate and rotating the alignment plate at the foot of the column.
Alignment aid mark (-45°, 0°, 45°)	✓
Fine alignment wheel	✓
Setscrews for leveling	✓
Spirit level	✓

Mechanics

Material	
Column profile	Aluminum (powder-coating)
Alignment plate	Aluminum (powder-coating)

¹⁾ L1 = Column profile height.

²⁾ L2 = Column height (incl. base plate, alignment plate and end cap).

³⁾ L3 = Mirror height.

	Base plate	Aluminum (powder-coating)
	Fine alignment wheel	PA6
	End cap	ABS
Dimensions		See dimensional drawing
	L1	2,314 mm ¹⁾
	L2	2,374.5 mm ²⁾
	L3	2,213 mm ³⁾
	Cross-section of column profile	136 mm x 75.7 mm
	Diameter of base plate	195 mm
Weight		13.41 kg

¹⁾ L1 = Column profile height.

²⁾ L2 = Column height (incl. base plate, alignment plate and end cap).

³⁾ L3 = Mirror height.

Classifications

ECLASS 5.0	27279207
ECLASS 5.1.4	27279207
ECLASS 6.0	27279207
ECLASS 6.2	27279207
ECLASS 7.0	27279207
ECLASS 8.0	27279207
ECLASS 8.1	27279207
ECLASS 9.0	27273605
ECLASS 10.0	27273605
ECLASS 11.0	27273605
ECLASS 12.0	27273605
ETIM 5.0	EC002467
ETIM 6.0	EC002467
ETIM 7.0	EC002467
ETIM 8.0	EC002467
UNSPSC 16.0901	39111609

Dimensional drawing PM4

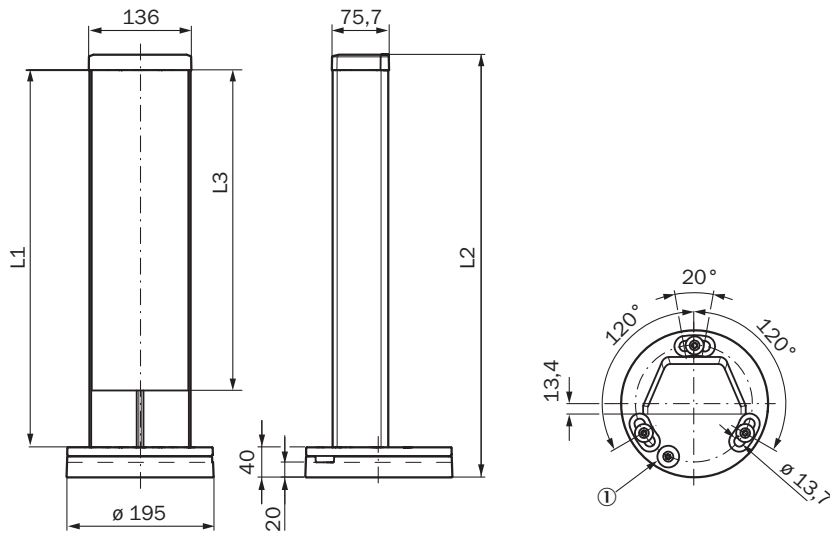

Dimensions in mm (inch)

① Fine alignment wheel

Type	Part no.	L1 = Column profile height	L2 = Column height (incl. base plate, alignment plate and end cap)	L3 = Mirror height
PM4-A09911000000	1138910	934	994,5	802
PM4-A10911000000	1138911	1034	1094,5	952
PM4-A11911000000	1138912	1134	1194,5	1102
PM4-A12911000000	1138913	1234	1294,5	1102
PM4-A14711000000	1138914	1414	1474,5	1402
PM4-A16211000000	1138915	1564	1625,5	1552
PM4-A17711000000	1138916	1714	1774,5	1702
PM4-A19211000000	1138917	1864	1924,5	1852
PM4-A20711000000	1138918	2014	2074,5	2002
PM4-A22211000000	1138919	2164	2224,5	2152
PM4-A23711000000	1138920	2314	2374,5	2213

SICK AT A GLANCE

SICK is one of the leading manufacturers of intelligent sensors and sensor solutions for industrial applications. A unique range of products and services creates the perfect basis for controlling processes securely and efficiently, protecting individuals from accidents and preventing damage to the environment.

We have extensive experience in a wide range of industries and understand their processes and requirements. With intelligent sensors, we can deliver exactly what our customers need. In application centers in Europe, Asia and North America, system solutions are tested and optimized in accordance with customer specifications. All this makes us a reliable supplier and development partner.

Comprehensive services complete our offering: SICK LifeTime Services provide support throughout the machine life cycle and ensure safety and productivity.

For us, that is “Sensor Intelligence.”

WORLDWIDE PRESENCE:

Contacts and other locations –www.sick.com