



MICS3-CBAC90IZ1

microScan3

SAFETY LASER SCANNERS

SICK
Sensor Intelligence.



Illustration may differ



Ordering information

Type	part no.
MICS3-CBAC90IZ1	1138053

Other models and accessories → www.sick.com/microScan3

Detailed technical data

Features

Product version	microScan3 Pro - EtherNet/IP
Model	Sensor without system plug, PS variant
Application	Indoor
Protective field range	9 m
Warning field range	64 m
Collision protection field range	19 m (on reference target)
Number of simultaneously monitored fields	≤ 4 ¹⁾
Number of fields	128
Number of monitoring cases	128
Scanning angle	275°
Resolution (can be configured)	30 mm 40 mm 50 mm 60 mm 70 mm 150 mm 200 mm
Angular resolution	0.1°
Response time	115 ms
Protective field supplement	100 mm

¹⁾ Protection, warning or contour detection fields.

Safety-related parameters

Type	Type 3 (IEC 61496)
Safety integrity level	SIL 2 (IEC 61508)
Category	Category 3 (EN ISO 13849)

Performance level	PL d (EN ISO 13849)
PFH_D (mean probability of a dangerous failure per hour)	8.0 x 10 ⁻⁸
T_M (mission time)	20 years (EN ISO 13849)
Safe state in the event of a fault	The safety outputs via the network are logic 0.

Functions

Restart interlock	✓
Multiple sampling	✓
Monitoring case switching	✓
Simultaneous monitoring	✓
Static protective field switching	✓
Collision protection field	✓
Safe contour detection	✓
Contour as a reference	✓
Integrated configuration memory	✓
Measured data output	Via Ethernet

Interfaces

Connection type	
Voltage supply	1 x male connector, M12, 4-pin, A-coded
Fieldbus, industrial network	2 x M12 female connectors, 4-pin, D-coded
Outputs	
OSSD pairs	0
Safety outputs via network	4
Configuration method	PC with Safety Designer (Configuration and Diagnostic Software)
Configuration and diagnostics interface	USB 2.0, Mini-USB, Ethernet
Data interface	
Services	EtherNet/IP™ CIP Safety™ CoLa 2 (configuration and diagnostics using Safety Designer) Data output DHCP SNMP SNTP (client and server)
Fieldbus, industrial network	EtherNet/IP™
Supported protocol versions	Common Industrial Protocol: The CIP Networks Library Volume 1, Edition 3.20 EtherNet/IP™: The CIP Networks Library Volume 2, Edition 1.21 CIP Safety™: The CIP Networks Library Volume 5, Edition 2.13
Topology support	DLR (Device Level Ring)
Display elements	Graphic color display, LEDs

Electronics

Protection class	III (EN 61140)
Supply voltage V_s	24 V DC (16.8 V DC ... 30 V DC)

Power consumption typical	7.2 W
----------------------------------	-------

Mechanics

Dimensions (W x H x D)	112 mm x 150.7 mm x 111.1 mm
Weight	1.45 kg
Housing material	Aluminum
Housing color	RAL 1021 (yellow), RAL 9005 (black)
Optics cover material	Polycarbonate
Optics cover surface finish	Outside with scratch-resistant coating

Ambient data

Enclosure rating	IP65 (IEC 60529)
Ambient light immunity	≤ 40 klx (IEC 61496-3) ¹⁾
Ambient operating temperature	-10 °C ... +50 °C
Storage temperature	-25 °C ... +70 °C
Vibration resistance	IEC 60068-2-6, IEC 60068-2-64, IEC 60721-3-5, IEC TR 60721-4-3, IEC 61496-1, IEC 61496-3
	Class 5M1 (IEC 60721-3-5)
	3M4 (IEC TR 60721-4-3)
Shock resistance	IEC 60068-2-27, IEC 60721-3-5, IEC TR 60721-4-3, IEC 61496-1, IEC 61496-3
	Class 5M1 (IEC 60721-3-5)
	3M4 (IEC TR 60721-4-3)
	Continuous shock 100 m/s ² , 16 ms
	150 m/s ² , 6 ms
EMC	IEC 61496-1, IEC 61000-6-2, IEC 61000-6-4

¹⁾ Typical ambient light immunity, for ambient light sources directly in the scan plane in accordance with IEC 61496-3: ≤ 3 klx.

Other information

Type of light	Pulsed laser diode
Wave length	845 nm
Detectable remission factor	1.8% to several 1000%
Laser class	1 (21 CFR 1040.10 and 1040.11, IEC 60825-1)

Certificates

EU declaration of conformity	✓
UK declaration of conformity	✓
ACMA declaration of conformity	✓
China RoHS	✓
cULus certificate	✓
Ethernet/IP certificate	✓
EC-Type-Examination approval	✓
Information according to Art. 3 of Data Act (Regulation EU 2023/2854)	✓

Classifications

ECLASS 5.0	27272705
-------------------	----------

ECLASS 5.1.4	27272705
ECLASS 6.0	27272705
ECLASS 6.2	27272705
ECLASS 7.0	27272705
ECLASS 8.0	27272705
ECLASS 8.1	27272705
ECLASS 9.0	27272705
ECLASS 10.0	27272705
ECLASS 11.0	27272705
ECLASS 12.0	27272705
ETIM 5.0	EC002550
ETIM 6.0	EC002550
ETIM 7.0	EC002550
ETIM 8.0	EC002550
UNSPSC 16.0901	39121528

Dimensional drawing

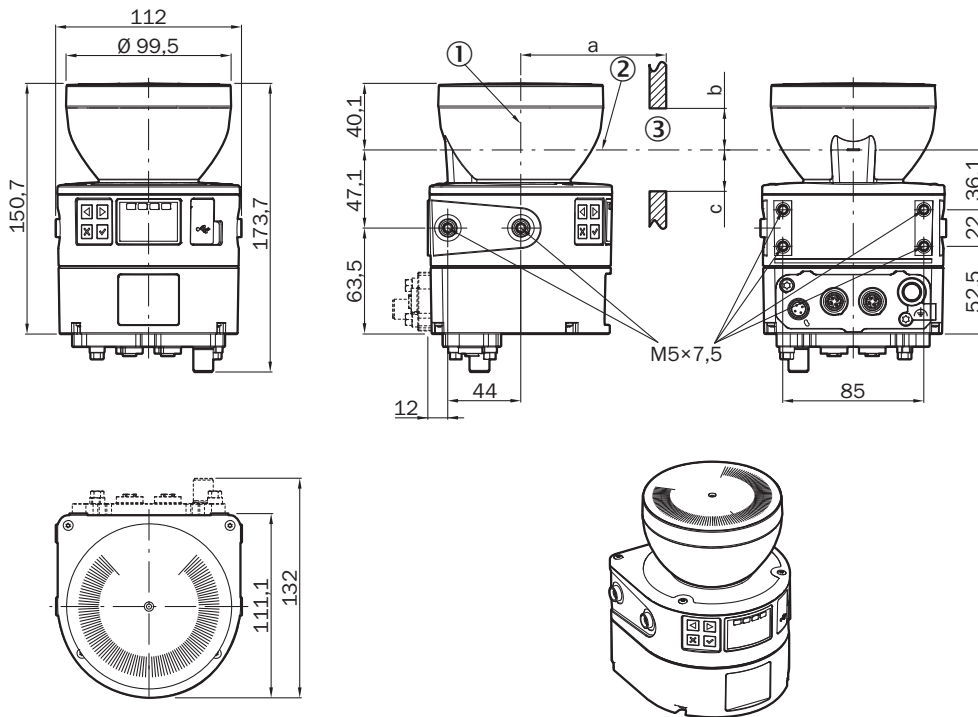

Dimensions in mm (inch)

- ① mirror axis of rotation
- ② scan plane
- ③ required viewing slit (a: length of the viewing slit, b: minimum height above the scan plane, c: minimum height below the scan plane. See the operating instructions for details.)

Pinouts Voltage supply (XD1)



Pin	Designation	Description
1	+24 V DC	Supply voltage +24 V DC
2	n.c.	Not connected
3	0 V DC	Supply voltage 0 V DC
4	FE	Functional earth/shielding
For details see operating instructions		



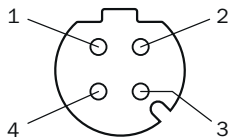



Pinouts Ethernet (XF1, XF2)







Pin	Designation	Description
1	TX+	Send data +
2	RX+	Receive data +
3	TX-	Send data -
4	RX-	Receive data -
Thread	SH	Shielding
For details see operating instructions		

Recommended accessories

Other models and accessories → www.sick.com/microScan3

	Brief description	Type	part no.
Mounting systems			
	<ul style="list-style-type: none"> Description: Mounting bracket, heavy-duty version, with protection cover, for floor mounting, height adjustment possible from 90 ... 310 mm, scanner tilt angle: ± 5°. Additional mounting brackets are not required. Dimensions (W x H x L): 200 mm x 366 mm x 269 mm Material: Steel Details: Steel, painted (RAL 1021) Color: RAL 1021 (yellow) Packing unit: 1 piece 	Heavy-duty mounting kit for floor mounting	2102289
	<ul style="list-style-type: none"> Description: Mounting bracket with protection of optics hood Material: Stainless steel Details: Stainless steel V2A (1.4301), powder-coated IGP-DURA face 5803A Color: RAL 9005 (black) Packing unit: 1 piece 	1b mounting kit	2074242
	<ul style="list-style-type: none"> Description: Mounting bracket Material: Stainless steel Details: Stainless steel V2A (1.4301), powder-coated IGP-DURA face 5803A Color: RAL 9005 (black) Packing unit: 1 piece 	Mounting kit 1a	2073851
	<ul style="list-style-type: none"> Description: Alignment bracket, alignment with cross-wise axis and depth axis possible, distance between mounting surface and device: 22.3 mm, only in conjunction with mounting kit 1a (2073851) or 1b (2074242) Material: Stainless steel Details: Stainless steel V2A (1.4301), powder-coated IGP-DURA face 5803A Color: RAL 9005 (black) Packing unit: 1 piece 	Mounting kit 2a	2073852
	<ul style="list-style-type: none"> Description: Mounting bracket 150 mm for floor mounting of microScan3 Material: Stainless steel Details: Stainless steel Color: Uncoated Packing unit: 1 piece Items supplied: Bracket and 4 x M5 screws for attaching the microScan3 	Mounting bracket 150 mm for floor mounting of microScan3	2112950
	<ul style="list-style-type: none"> Description: Mounting bracket 300 mm for floor mounting of microScan3 Material: Stainless steel Details: Stainless steel Color: Uncoated Packing unit: 1 piece Items supplied: Bracket and 4 x M5 screws for attaching the microScan3 	Mounting bracket 300 mm for floor mounting of microScan3	2112951
	<ul style="list-style-type: none"> Description: Alignment bracket, alignment with cross-wise axis and depth axis possible, distance between mounting surface and device: 52.3 mm, only in conjunction with mounting kit 1a (2073851) or 1b (2074242) Material: Stainless steel Details: Stainless steel V2A (1.4301), powder-coated IGP-DURA face 5803A Color: RAL 9005 (black) Packing unit: 1 piece 	Mounting kit 2b	2074184

	Brief description	Type	part no.
connectors and cables			
	<ul style="list-style-type: none"> • Connection type head A: Male connector, M12, 4-pin, straight, D-coded • Connection type head B: Male connector, RJ45, 8-pin, straight • Signal type: Ethernet • Cable: 20 m, 4-wire, CAT5, CAT5e, PUR, halogen-free • Description: Ethernet, shielded 	SSL-2J04-G20ME60	6063700
	<ul style="list-style-type: none"> • Connection type head A: Male connector, M12, 4-pin, angled, D-coded • Connection type head B: Male connector, RJ45, 8-pin, straight • Signal type: Ethernet • Cable: 20 m, 4-wire, CAT5, CAT5e, PUR, halogen-free • Description: Ethernet, shielded 	SSL-2J04-H20ME	6063701
	<ul style="list-style-type: none"> • Description: Sensor/actuator cable, unshielded • Connection type head A: Female connector, M12, 4-pin, angled, A-coded • Connection type head B: Flying leads • Signal type: Sensor/actuator cable • Cable: 20 m, 4-wire, PUR, halogen-free • Application: Drag chain operation, Zones with oils and lubricants, Robot, Drag chain operation 	YG2A14-200UB3XLEAX	2095770
	<ul style="list-style-type: none"> • Description: Sensor/actuator cable, unshielded • Connection type head A: Female connector, M12, 4-pin, angled, A-coded • Connection type head B: Flying leads • Signal type: Sensor/actuator cable • Cable: 2 m, 4-wire, PUR, halogen-free • Application: Drag chain operation, Zones with oils and lubricants, Robot, Drag chain operation 	YG2A14-020UB3XLEAX	2095766
	<ul style="list-style-type: none"> • Description: Sensor/actuator cable, unshielded • Connection type head A: Female connector, M12, 4-pin, angled, A-coded • Connection type head B: Flying leads • Signal type: Sensor/actuator cable • Cable: 5 m, 4-wire, PUR, halogen-free • Application: Drag chain operation, Zones with oils and lubricants, Robot, Drag chain operation 	YG2A14-050UB3XLEAX	2095767
	<ul style="list-style-type: none"> • Description: Sensor/actuator cable, unshielded • Connection type head A: Female connector, M12, 4-pin, angled, A-coded • Connection type head B: Flying leads • Signal type: Sensor/actuator cable • Cable: 10 m, 4-wire, PUR, halogen-free • Application: Drag chain operation, Zones with oils and lubricants, Robot, Drag chain operation 	YG2A14-100UB3XLEAX	2095768
	<ul style="list-style-type: none"> • Description: Sensor/actuator cable, unshielded • Connection type head A: Female connector, M12, 4-pin, straight, A-coded • Connection type head B: Flying leads • Signal type: Sensor/actuator cable • Cable: 2 m, 4-wire, PUR, halogen-free • Application: Drag chain operation, Zones with oils and lubricants, Robot, Drag chain operation 	YF2A14-020UB3XLEAX	2095607
	<ul style="list-style-type: none"> • Description: Sensor/actuator cable, unshielded • Connection type head A: Female connector, M12, 4-pin, straight, A-coded • Connection type head B: Flying leads • Signal type: Sensor/actuator cable • Cable: 5 m, 4-wire, PUR, halogen-free • Application: Drag chain operation, Zones with oils and lubricants, Robot, Drag chain operation 	YF2A14-050UB3XLEAX	2095608
	<ul style="list-style-type: none"> • Description: Sensor/actuator cable, unshielded • Connection type head A: Female connector, M12, 4-pin, straight, A-coded • Connection type head B: Flying leads • Signal type: Sensor/actuator cable • Cable: 10 m, 4-wire, PUR, halogen-free • Application: Drag chain operation, Zones with oils and lubricants, Robot, Drag chain operation 	YF2A14-100UB3XLEAX	2095609
	<ul style="list-style-type: none"> • Description: Sensor/actuator cable, unshielded • Connection type head A: Female connector, M12, 4-pin, straight, A-coded • Connection type head B: Flying leads • Signal type: Sensor/actuator cable • Cable: 20 m, 4-wire, PUR, halogen-free • Application: Drag chain operation, Zones with oils and lubricants, Robot, Drag chain operation 	YF2A14-200UB3XLEAX	2095611
	<ul style="list-style-type: none"> • Description: Sensor/actuator cable, unshielded • Connection type head A: Female connector, M12, 4-pin, straight, A-coded • Connection type head B: Flying leads • Signal type: Sensor/actuator cable • Cable: 0.6 m, 4-wire, PUR, halogen-free 	YF2A14-C60UB3XLEAX	2145654

	Brief description	Type	part no.
	<ul style="list-style-type: none"> Application: Drag chain operation, Zones with oils and lubricants, Robot, Drag chain operation Description: Sensor/actuator cable, unshielded Connection type head A: Female connector, M12, 4-pin, straight, A-coded Connection type head B: Flying leads Signal type: Sensor/actuator cable Cable: 1 m, 4-wire, PUR, halogen-free Application: Drag chain operation, Zones with oils and lubricants, Robot, Drag chain operation 	YF2A14-010UB3XLEAX	2145655
	<ul style="list-style-type: none"> Description: Sensor/actuator cable, unshielded Connection type head A: Female connector, M12, 4-pin, straight, A-coded Connection type head B: Flying leads Signal type: Sensor/actuator cable Cable: 3 m, 4-wire, PUR, halogen-free Application: Drag chain operation, Zones with oils and lubricants, Robot, Drag chain operation 	YF2A14-030UB3XLEAX	2145656
	<ul style="list-style-type: none"> Description: Sensor/actuator cable, unshielded Connection type head A: Female connector, M12, 4-pin, angled, A-coded Connection type head B: Flying leads Signal type: Sensor/actuator cable Cable: 0.6 m, 4-wire, PUR, halogen-free Application: Drag chain operation, Zones with oils and lubricants, Robot, Drag chain operation 	YG2A14-C60UB3XLEAX	2145657
	<ul style="list-style-type: none"> Description: Sensor/actuator cable, unshielded Connection type head A: Female connector, M12, 4-pin, angled, A-coded Connection type head B: Flying leads Signal type: Sensor/actuator cable Cable: 1 m, 4-wire, PUR, halogen-free Application: Drag chain operation, Zones with oils and lubricants, Robot, Drag chain operation 	YG2A14-010UB3XLEAX	2145658
system plugs and extension modules			
	<ul style="list-style-type: none"> Description: Integrated configuration memory 	MICSX-BANNZZZ1	2086102

SICK AT A GLANCE

SICK is one of the leading manufacturers of intelligent sensors and sensor solutions for industrial applications. A unique range of products and services creates the perfect basis for controlling processes securely and efficiently, protecting individuals from accidents and preventing damage to the environment.

We have extensive experience in a wide range of industries and understand their processes and requirements. With intelligent sensors, we can deliver exactly what our customers need. In application centers in Europe, Asia and North America, system solutions are tested and optimized in accordance with customer specifications. All this makes us a reliable supplier and development partner.

Comprehensive services complete our offering: SICK LifeTime Services provide support throughout the machine life cycle and ensure safety and productivity.

For us, that is “Sensor Intelligence.”

WORLDWIDE PRESENCE:

Contacts and other locations –www.sick.com