



CLV601-3E201

CLV60x

FIXED MOUNT BARCODE SCANNERS

SICK
Sensor Intelligence.



Ordering information

Type	part no.
CLV601-3E201	1136147

Other models and accessories → www.sick.com/CLV60x



Detailed technical data

Features

Connection type	Cable						
Reading field	Side						
Sensor type	Line scanner						
Optical focus	Fixed focus (31 mm)						
Sensor	CMOS line sensor						
Sensor resolution	2,048 px						
Light source	Light spot, LED, Visible, Red, 626 nm						
Aperture angle	≤ 71°						
Reading distance	15 mm ... 70 mm ¹⁾						
Scanning frequency	750 Hz						
Reading angle	<table border="0"> <tbody> <tr> <td>Tilt α</td> <td>± 5° (with code resolution ≥ 0.2 mm) ± 10° (with code resolution ≥ 0.25 mm) ± 15° (with code resolution ≥ 0.35 mm) ± 25° (with code resolution ≥ 0.5 mm)</td> </tr> <tr> <td>Pitch β</td> <td>± 6° (with code resolution ≥ 0.2 mm) ± 15° (with code resolution ≥ 0.35 mm)</td> </tr> <tr> <td>Skew γ</td> <td>± 20° (with code resolution ≥ 0.2 mm) ± 30° (with code resolution ≥ 0.5 mm)</td> </tr> </tbody> </table>	Tilt α	± 5° (with code resolution ≥ 0.2 mm) ± 10° (with code resolution ≥ 0.25 mm) ± 15° (with code resolution ≥ 0.35 mm) ± 25° (with code resolution ≥ 0.5 mm)	Pitch β	± 6° (with code resolution ≥ 0.2 mm) ± 15° (with code resolution ≥ 0.35 mm)	Skew γ	± 20° (with code resolution ≥ 0.2 mm) ± 30° (with code resolution ≥ 0.5 mm)
Tilt α	± 5° (with code resolution ≥ 0.2 mm) ± 10° (with code resolution ≥ 0.25 mm) ± 15° (with code resolution ≥ 0.35 mm) ± 25° (with code resolution ≥ 0.5 mm)						
Pitch β	± 6° (with code resolution ≥ 0.2 mm) ± 15° (with code resolution ≥ 0.35 mm)						
Skew γ	± 20° (with code resolution ≥ 0.2 mm) ± 30° (with code resolution ≥ 0.5 mm)						
Code resolution	0.125 mm ... 0.5 mm						

¹⁾ For details see reading field diagram.

Mechanics/electronics

Connection type	1 x 15-pin D-SUB plug (2 m)
Supply voltage	12 V DC ... 24 V DC, ± 15 %
Power consumption	Typ. 1.5 W

Housing material	Zinc diecast
Housing color	Light blue (RAL 5012), black (RAL 9005)
Window material	Plastic
Enclosure rating	IP40 (DIN 40 050)
Protection class	III (VDE 0106/IEC 1010-1)
Weight	230 g, with connecting cable
Dimensions (L x W x H)	55 mm x 52 mm x 20 mm
MTBF	100,000 h

Performance

Readable code structures	1D codes
Bar code types	All current code types, Code 39, Code 128, Code 93, Codabar, UPC / GTIN / EAN, Interleaved 2 of 5
Code printing process	Label (printed codes)
Print ratio	2:1 ... 3:1
No. of codes per scan	1 ... 1
No. of codes per reading interval	1 ... 15 (auto-discriminating)
No. of characters per reading interval	450
Number of characters per code	≤ 30
No. of multiple readings	1 ... 100

Interfaces

Serial	✓ , RS-232
Function	Data interface (read result output), Service interface
Data transmission rate	2,400 Baud ... 250 kBaud, AUX: 57.6 kBaud
Digital inputs	1 ("Input 1", Vin = max. 30 V)
Reading pulse	Start: Digital input, free, command, auto pulse, stop: Digital input, free, command, timer, Good Read
Optical indicators	1 RGB LED (multifunctional)
Acoustic indicators	Beeper/buzzer (can be switched off, can be allocated as a result indication function)
Configuration software	SOPAS ET

Ambient data

Electromagnetic compatibility (EMC)	EN 61000-6-2:2005 / EN 61000-6-3:2007+A1:2011
Vibration resistance	EN 60068-2-6:2008-02
Shock resistance	EN 60068-2-27:2009-05
Ambient operating temperature	0 °C ... +50 °C
Storage temperature	-20 °C ... +70 °C
Relative humidity	90 %, Non-condensing
Ambient light immunity	5,000 lx, on barcode
Bar code print contrast (PCS)	≥ 60 %

General notes

Items supplied	Single scanner, Safety Notes
-----------------------	------------------------------

Certificates

EU declaration of conformity	✓
UK declaration of conformity	✓
ACMA declaration of conformity	✓
China RoHS	✓
cULus certificate	✓
Information according to Art. 3 of Data Act (Regulation EU 2023/2854)	✓

Classifications

ECLASS 5.0	27280102
ECLASS 5.1.4	27280102
ECLASS 6.0	27280102
ECLASS 6.2	27280102
ECLASS 7.0	27280102
ECLASS 8.0	27280102
ECLASS 8.1	27280102
ECLASS 9.0	27280102
ECLASS 10.0	27280102
ECLASS 11.0	27280102
ECLASS 12.0	27280102
ETIM 5.0	EC002550
ETIM 6.0	EC002550
ETIM 7.0	EC002550
ETIM 8.0	EC002550
UNSPSC 16.0901	43211701

Dimensional drawing CLV60x side

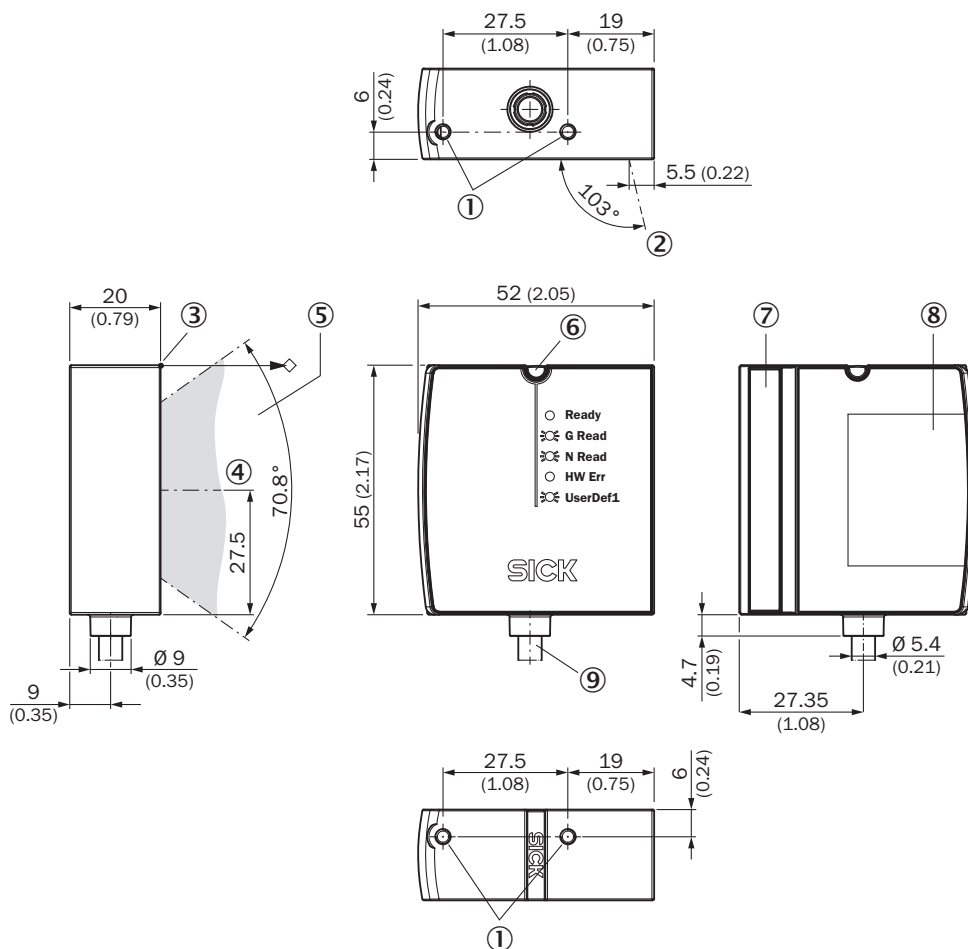

Dimensions in mm (inch)





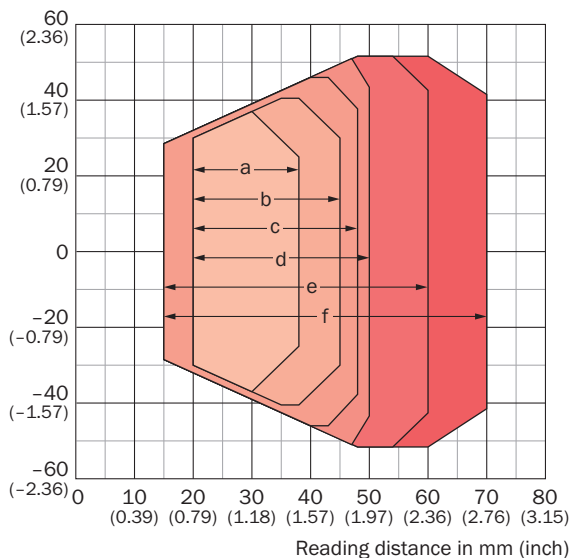

- ① Mounting thread M3 x 5 mm
- ② Optical axis, reading window
- ③ Reading distance reference point
- ④ Reading field axis center
- ⑤ Reading field
- ⑥ status LED
- ⑦ Reading field
- ⑧ type label
- ⑨ Connection cable

Reading field diagram

Reading field height in mm (inch)



Resolution

 a: 0.125 mm (4.9 mil)	 d: 0.25 mm (9.8 mil)
 b: 0.15 mm (5.9 mil)	 e: 0.35 mm (13.8 mil)
 c: 0.2 mm (7.9 mil)	 f: 0.5 mm (19.7 mil)

Connection type

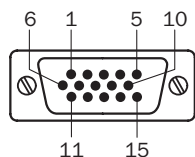

- ① + 24 V
- ② RxD (Aux)
- ③ TxD (Aux)
- ④ Not connected
- ⑤ GND
- ⑥ Not connected
- ⑦ RxD (HOST)
- ⑧ Not connected
- ⑨ TxD (HOST)
- ⑩ Not connected
- ⑪ Not connected
- ⑫ Out 1
- ⑬ Out 2
- ⑭ In 1
- ⑮ Not connected

SICK AT A GLANCE

SICK is one of the leading manufacturers of intelligent sensors and sensor solutions for industrial applications. A unique range of products and services creates the perfect basis for controlling processes securely and efficiently, protecting individuals from accidents and preventing damage to the environment.

We have extensive experience in a wide range of industries and understand their processes and requirements. With intelligent sensors, we can deliver exactly what our customers need. In application centers in Europe, Asia and North America, system solutions are tested and optimized in accordance with customer specifications. All this makes us a reliable supplier and development partner.

Comprehensive services complete our offering: SICK LifeTime Services provide support throughout the machine life cycle and ensure safety and productivity.

For us, that is “Sensor Intelligence.”

WORLDWIDE PRESENCE:

Contacts and other locations –www.sick.com