



# IMG30-20NPSZU2K

IMG

INDUCTIVE PROXIMITY SENSORS

**SICK**  
Sensor Intelligence.



### Ordering information

| Type            | part no. |
|-----------------|----------|
| IMG30-20NPSZU2K | 1135619  |

**Included in delivery:** BEF-MU-M30 (1)

Other models and accessories → [www.sick.com/IMG](http://www.sick.com/IMG)

Illustration may differ



### Detailed technical data

#### Features

|  |   |
|--|---|
| <b>Housing</b>                             | Metric  |
| <b>Housing</b>                             | Short-body  |
| <b>Thread size</b>                         | M30 x 1.5   |
| <b>Diameter</b>                            | Ø 30 mm   |
| <b>Sensing range <math>S_n</math></b>      | 20 mm   |
| <b>Safe sensing range <math>S_a</math></b> | 16.2 mm   |
| <b>Installation type</b>                   | Non-flush   |
| <b>Switching frequency</b>                 | 500 Hz  |
| <b>Connection type</b>                     | Cable, 3-wire, 2 m  |
| <b>Switching output</b>                    | PNP   |
| <b>Switching output detail</b>             | PNP   |
| <b>Output function</b>                     | NO  |
| <b>Electrical wiring</b>                   | DC 3-wire   |
| <b>Enclosure rating</b>                    | IP67 <sup>1)</sup><br>IP68 <sup>1)</sup><br>IP69K <sup>2)</sup>                       |
| <b>Special features</b>                    | Resistant against coolant lubricants, Temperature resistance                          |
| <b>Special applications</b>                | Zones with coolants and lubricants, Mobile machines, Difficult application conditions |
| <b>Items supplied</b>                      | Mounting nut, brass, nickel-plated (2x)   |

<sup>1)</sup> According to EN 60529.

<sup>2)</sup> According to ISO 20653:2013-03.

#### Mechanics/electronics

|                       |                     |
|-----------------------|---------------------|
| <b>Supply voltage</b> | 10 V DC ... 30 V DC |
|-----------------------|---------------------|

<sup>1)</sup> At  $I_a$  max.

<sup>2)</sup> Supply voltage  $U_B$  and constant ambient temperature  $T_a$ .

<sup>3)</sup> Of  $S_r$ .

|   |   |
|---|---|
| <b>Ripple</b>                               | ≤ 10 %  |
| <b>Voltage drop</b>                         | ≤ 2 V <sup>1)</sup>   |
| <b>Time delay before availability</b>       | ≤ 100 ms  |
| <b>Hysteresis</b>                           | 3 % ... 20 %  |
| <b>Reproducibility</b>                      | ≤ 2 % <sup>2)</sup><br>3)   |
| <b>Temperature drift (of S<sub>r</sub>)</b> | ± 10 %  |
| <b>EMC</b>                                  | According to EN 60947-5-2   |
| <b>Environmental test</b>                   | Quick temperature change EN 60068-2-14, Na: TA = -25 °C, TB = 75 °C, t1 = 40 min, t2 = < 10 s, 300 cycles   |
| <b>Corrosion test</b>                       | Salt spray test EN 60068-2-52: severity 5, 4 cycles   |
| <b>Continuous current I<sub>a</sub></b>     | ≤ 200 mA  |
| <b>No load current</b>                      | ≤ 10 mA   |
| <b>Cable material</b>                       | PUR   |
| <b>Conductor size</b>                       | 0.25 mm <sup>2</sup>  |
| <b>Cable diameter</b>                       | Ø 3.9 mm  |
| <b>Bending radius</b>                       | With fixed installation > 5 x cable diameter<br>For flexible use > 10 x cable diameter  |
| <b>Short-circuit protection</b>             | ✓   |
| <b>Power-up pulse protection</b>            | ✓   |
| <b>Shock and vibration resistance</b>       | Vibration resistance acc. to EN 60068-2-6 Fc: 60 g peak (10 Hz ... 2,000 Hz)<br>Long-term shock resistance acc. to EN 60068-2-27 Ea: 100 g 2 ms sinusoidal; 500 shocks in each direction of the 3 coordinate axes<br>Broadband noise acc. to EN 60068-2-64: 15 g rms (5 Hz ... 2,000 Hz) / 8 hours in each direction of the 3 coordinate axes |
| <b>Display</b>                              | LED yellow<br>Switching status<br>Permanently on: Switching output active   |
| <b>Ambient operating temperature</b>        | -40 °C ... +85 °C   |
| <b>Housing material</b>                     | Nickel-plated brass   |
| <b>Sensing face material</b>                | Plastic, LCP  |
| <b>Housing length</b>                       | 41 mm   |
| <b>Thread length</b>                        | 24.5 mm   |
| <b>Tightening torque, max.</b>              | ≤ 70 Nm   |
| <b>Protection class</b>                     | III   |
| <b>UL File No.</b>                          | E181493   |

1) At I<sub>a</sub> max.

2) Supply voltage U<sub>B</sub> and constant ambient temperature Ta.

3) Of S<sub>r</sub>.

### Safety-related parameters

|                                     |             |
|-------------------------------------|-------------|
| <b>MTTF<sub>D</sub></b>             | 1,820 years |
| <b>DC<sub>avg</sub></b>             | 0 %         |
| <b>T<sub>M</sub> (mission time)</b> | 20 years    |

### Reduction factors

|                                   |  |
|-----------------------------------|--|
| <b>Note</b>                       | The values are reference values which may vary |
| <b>St37 steel (Fe)</b>            | 1  |
| <b>Stainless steel (V2A, 304)</b> | Approx. 0.87                                   |
| <b>Aluminum (Al)</b>              | Approx. 0.49                                   |
| <b>Copper (Cu)</b>                | Approx. 0.42                                   |
| <b>Brass (Br)</b>                 | Approx. 0.51                                   |

### Installation note

|               |                                       |
|---------------|---------------------------------------|
| <b>Remark</b> | Associated graphic see "Installation" |
| <b>A</b>      | 30 mm                                 |
| <b>B</b>      | 80 mm                                 |
| <b>C</b>      | 30 mm                                 |
| <b>D</b>      | 60 mm                                 |
| <b>E</b>      | 20 mm                                 |
| <b>F</b>      | 160 mm                                |

### Classifications

|                       |          |
|-----------------------|----------|
| <b>ECLASS 5.0</b>     | 27270101 |
| <b>ECLASS 5.1.4</b>   | 27270101 |
| <b>ECLASS 6.0</b>     | 27270101 |
| <b>ECLASS 6.2</b>     | 27270101 |
| <b>ECLASS 7.0</b>     | 27270101 |
| <b>ECLASS 8.0</b>     | 27270101 |
| <b>ECLASS 8.1</b>     | 27270101 |
| <b>ECLASS 9.0</b>     | 27270101 |
| <b>ECLASS 10.0</b>    | 27270101 |
| <b>ECLASS 11.0</b>    | 27270101 |
| <b>ECLASS 12.0</b>    | 27274001 |
| <b>ETIM 5.0</b>       | EC002714 |
| <b>ETIM 6.0</b>       | EC002714 |
| <b>ETIM 7.0</b>       | EC002714 |
| <b>ETIM 8.0</b>       | EC002714 |
| <b>UNSPSC 16.0901</b> | 39122230 |

### Certificates

|   |   |
|---|---|
| <b>EU declaration of conformity</b>       | ✓ |
| <b>UK declaration of conformity</b>       | ✓ |
| <b>ACMA declaration of conformity</b>     | ✓ |
| <b>Moroccan declaration of conformity</b> | ✓ |
| <b>China RoHS</b>                         | ✓ |
| <b>cULus certificate</b>                  | ✓ |

Installation note Non-flush installation

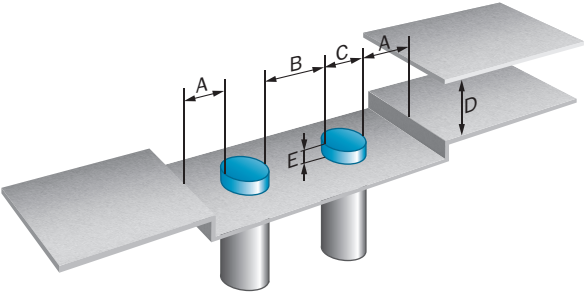

Connection diagram Cd-001

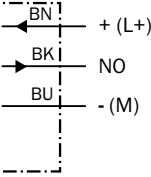

Response diagram

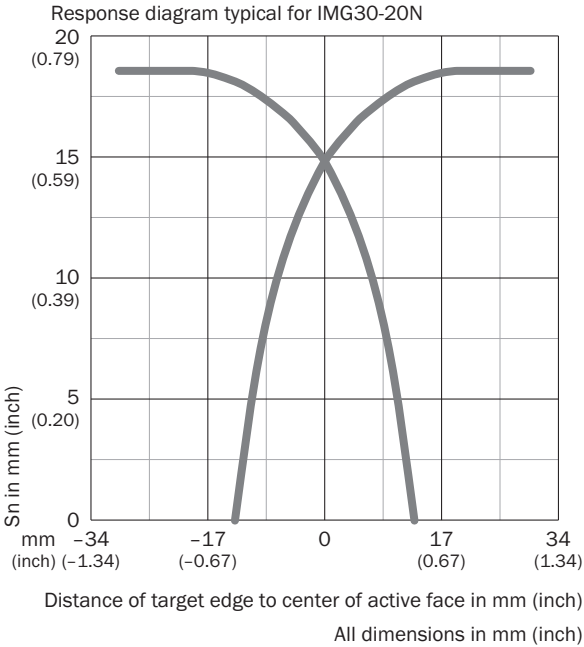

### Functional principle

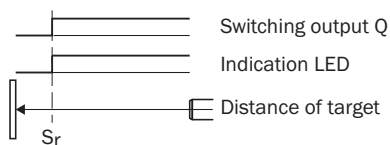

### Dimensional drawing IMG30, short variant, cable, non flush

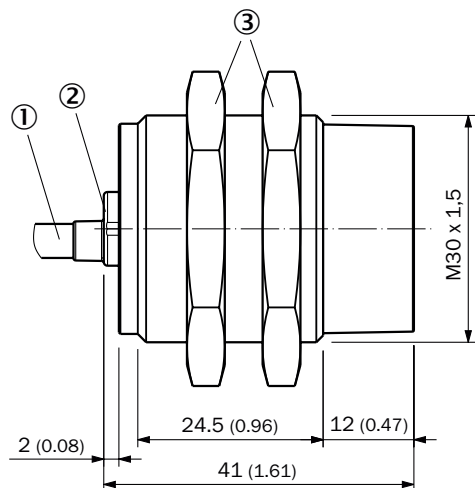





Dimensions in mm (inch)

- ① Connection
- ② Display LED
- ③ Fastening nuts (2x); AF36; nickel-plated brass

### Recommended accessories

Other models and accessories → [www.sick.com/IMG](http://www.sick.com/IMG)

|   | Brief description  | Type       | part no. |
|---|--|------------|----------|
| <b>Mounting systems</b>   |  |            |          |
|  | <ul style="list-style-type: none"> <li>• <b>Description:</b> Mounting plate for M30 sensors</li> <li>• <b>Material:</b> Steel</li> <li>• <b>Details:</b> Steel, zinc coated</li> <li>• <b>Items supplied:</b> Without mounting hardware</li> </ul>   | BEF-WG-M30 | 5321871  |
|  | <ul style="list-style-type: none"> <li>• <b>Description:</b> Mounting bracket for M30 sensors</li> <li>• <b>Material:</b> Steel</li> <li>• <b>Details:</b> Steel, zinc coated</li> <li>• <b>Items supplied:</b> Without mounting hardware</li> </ul> | BEF-WN-M30 | 5308445  |

|   | Brief description   | Type        | part no. |
|---|---|-------------|----------|
| connectors and cables   |   |             |          |
|  | <ul style="list-style-type: none"> <li>• <b>Connection type head A:</b> Female connector, M12, 4-pin, straight, A-coded</li> <li>• <b>Description:</b> Unshielded</li> <li>• <b>Connection systems:</b> Screw-type terminals</li> <li>• <b>Permitted cross-section:</b> ≤ 0.75 mm<sup>2</sup></li> <li>• <b>Application:</b> Hygienic and washdown zones</li> </ul> | DOS-1204-GN | 6028357  |
|  | <ul style="list-style-type: none"> <li>• <b>Connection type head A:</b> Male connector, M12, 4-pin, straight, A-coded</li> <li>• <b>Description:</b> Unshielded</li> <li>• <b>Connection systems:</b> Screw-type terminals</li> <li>• <b>Permitted cross-section:</b> ≤ 0.75 mm<sup>2</sup></li> <li>• <b>Application:</b> Hygienic and washdown zones</li> </ul>   | STE-1204-GN | 6028359  |
|  | <ul style="list-style-type: none"> <li>• <b>Connection type head A:</b> Female connector, M12, 4-pin, angled, A-coded</li> <li>• <b>Description:</b> Unshielded</li> <li>• <b>Connection systems:</b> Screw-type terminals</li> <li>• <b>Permitted cross-section:</b> ≤ 0.75 mm<sup>2</sup></li> <li>• <b>Application:</b> Hygienic and washdown zones</li> </ul>   | DOS-1204-WN | 6028358  |

## SICK AT A GLANCE

SICK is one of the leading manufacturers of intelligent sensors and sensor solutions for industrial applications. A unique range of products and services creates the perfect basis for controlling processes securely and efficiently, protecting individuals from accidents and preventing damage to the environment.

We have extensive experience in a wide range of industries and understand their processes and requirements. With intelligent sensors, we can deliver exactly what our customers need. In application centers in Europe, Asia and North America, system solutions are tested and optimized in accordance with customer specifications. All this makes us a reliable supplier and development partner.

Comprehensive services complete our offering: SICK LifeTime Services provide support throughout the machine life cycle and ensure safety and productivity.

For us, that is “Sensor Intelligence.”

## WORLDWIDE PRESENCE:

Contacts and other locations –[www.sick.com](http://www.sick.com)