



DAXLAN-0700BA080000W01

DAX

MAGNETOSTRICTIVE LINEAR ENCODERS

SICK
Sensor Intelligence.



Illustration may differ

Ordering information

Type	part no.
DAXLAN-0700BA08000W01	1133518

Other models and accessories → www.sick.com/DAX



Detailed technical data

Safety-related parameters

MTTF_D (mean time to dangerous failure)	123 years ¹⁾
--	-------------------------

¹⁾ This product is a standard product and does not constitute a safety component as defined in the Machinery Directive. Calculation based on nominal load of components, average ambient temperature 40°C, frequency of use 8760 h/a. All electronic failures are considered hazardous. For more information, see document no. 8015532.

Performance

Linearity	≤ 0.03% F.S. (Minimum 90 μm) ^{1) 2)}
Repeatability	≤ ± 20 μm
Measured values	Positioning
Measuring range	0 mm ... 700 mm
Unusable range	
Null zone	55 mm
Damping zone	63 mm
Magnet type	
Magnet shape	Small block magnet
Configured for number of magnets	1 piece
Magnet travel speed	Any
Measuring frequency (internal)	< 2 ms

¹⁾ Systematic position measurement deviation according to DIN ISO 1319-1 (value includes all systematic errors or deviations from the actual position value, e.g. repeatability and hysteresis).

²⁾ In principle, the size of the measurement deviation is limited by the resolution of the interface.

Interfaces

Communication interface	Analog
Communication Interface detail	Current
Output signal	4 mA ... 20 mA
Signals	
Number of signals	Two output signals (one output signal + an inverted second output signal)
Sequence of signals	Signal 1: rising, signal 2: falling
Load resistance	100 Ω ... 500 Ω

Electronics

Connection type	Male connector, M12, 8-pin
Pinouts	1=Output signal ground (0 V PIN 3); 2=Output signal ground (0 V PIN 5); 3=Signal 2; 4=n.c.; 5=Signal 1; 6=Power ground; 7=+24 V DC; 8=n.c.
Male connector coding	A-coded
Supply voltage	24 V DC ($\pm 20\%$)
Current consumption	50...100 mA
Reverse polarity protection	Up to -30 V DC
Residual ripple	≤ 0.28 V _{pp}
Dielectric strength	500 V DC, 0 V against housing
Over voltage protection	≤ 36 V DC

Mechanics

Mechanical design	DAX Low Profile
Material	
Housing	Aluminum (anodised), zinc, stainless steel, brass
Mounting bracket	Stainless steel 1.4301

Ambient data

EMC	According to EN 61000-6-2 and EN 61000-6-4
Enclosure rating	IP65 / IP67 ¹⁾
Temperature	
Operating temperature range	-40 °C ... $+85$ °C
Storage temperature range	-40 °C ... $+85$ °C
Permissible relative humidity	90 % (Condensation not permitted)
Resistance to shocks	100 g, 6 ms (IEC 60068-2-27)
Resistance to vibration	8 g / 10...2,000 Hz according to IEC 60068-2-6 ²⁾

¹⁾ In correctly assembled mating connector.

²⁾ Resonance frequencies can influence signal quality.

General notes

Items supplied	
	Mounting brackets and position magnet included. Mounting material for base not included.

Certificates

EU declaration of conformity	✓
UK declaration of conformity	✓
ACMA declaration of conformity	✓
Moroccan declaration of conformity	✓
China RoHS	✓
cULus certificate	✓
Information according to Art. 3 of Data Act (Regulation EU 2023/2854)	✓

Classifications

ECLASS 5.0	27270705
-------------------	----------

ECLASS 5.1.4	27270705
ECLASS 6.0	27270705
ECLASS 6.2	27270705
ECLASS 7.0	27270705
ECLASS 8.0	27270705
ECLASS 8.1	27270705
ECLASS 9.0	27270705
ECLASS 10.0	27270705
ECLASS 11.0	27270705
ECLASS 12.0	27274304
ETIM 5.0	EC002544
ETIM 6.0	EC002544
ETIM 7.0	EC002544
ETIM 8.0	EC002544
UNSPSC 16.0901	41111613

DAX Low Profile



Dimensions in mm (inch)

① Measuring range

Dimensional drawing Block magnet MAG-B-180-xx

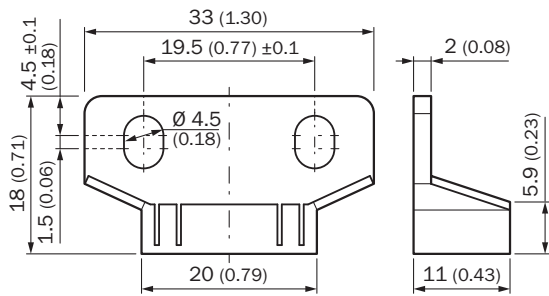

Dimensions in mm (inch)

positioning of mounting bracket

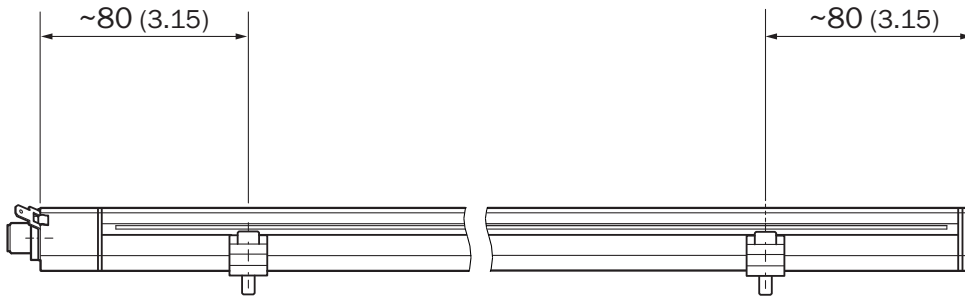

Dimensions in mm (inch)

distance of position magnets

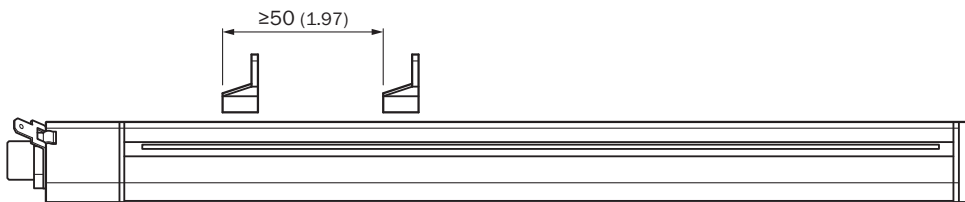

Dimensions in mm (inch)

distance tolerance

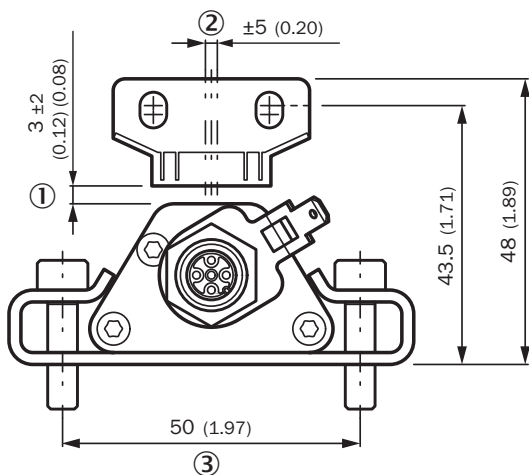

Dimensions in mm (inch)

- ① nominal distance + permissible amount of distance tolerance
- ② permissible center offset
- ③ recommendation: M5 x 20

Anschlussbelegung







M12 male connector, 8-pin	Signal
1	Output signal ground (0 V PIN 3)

M12 male connector, 8-pin	Signal
2	Output signal ground (0 V PIN 5)
3	Signal 2
4	n.c.
5	Signal 1
6	Power Ground
7	+24 V DC
8	n.c.

Recommended accessories

Other models and accessories → www.sick.com/DAX

	Brief description	Type	part no.
Mounting systems			
	<ul style="list-style-type: none"> Description: Replacement clamping bracket for DAX® Low Profile without fastening material Dimensions (W x H x L): 15 mm x 16 mm x 68 mm Color: Metallic Items supplied: 2 pieces 	BEF-KH-LP1-02	2125244
	<ul style="list-style-type: none"> Description: Replacement clamping bracket for DAX® Low Profile without fastening material Dimensions (W x H x L): 15 mm x 16 mm x 68 mm Color: Metallic Items supplied: 3 pieces 	BEF-KH-LP1-03	2125245
	<ul style="list-style-type: none"> Description: Replacement clamping bracket for DAX® Low Profile without fastening material Dimensions (W x H x L): 15 mm x 16 mm x 68 mm Color: Metallic Items supplied: 4 pieces 	BEF-KH-LP1-04	2125246
magnets			
	<ul style="list-style-type: none"> Product segment: Magnets Product: Position magnets Description: Small block magnet for magnetostrictive linear encoders 	MAG-B-180-01	2129171

	Brief description	Type	part no.
connectors and cables			
	<ul style="list-style-type: none"> • Connection type head A: Female connector, M12, 8-pin, straight • Connection type head B: Flying leads • Signal type: Incremental, SSI • Cable: 2 m, 8-wire, PUR, halogen-free • Description: Incremental, shielded, SSI • Connection systems: Flying leads • Application: Drag chain operation, Zones with oils and lubricants 	DOL-1208-G02MAC1	6032866
	<ul style="list-style-type: none"> • Connection type head A: Female connector, M12, 8-pin, straight • Connection type head B: Flying leads • Signal type: Incremental, SSI • Cable: 5 m, 8-wire, PUR, halogen-free • Description: Incremental, shielded, SSI • Connection systems: Flying leads • Application: Drag chain operation, Zones with oils and lubricants 	DOL-1208-G05MAC1	6032867
	<ul style="list-style-type: none"> • Connection type head A: Female connector, M12, 8-pin, straight • Connection type head B: Flying leads • Signal type: Incremental, SSI • Cable: 10 m, 8-wire, PUR, halogen-free • Description: Incremental, shielded, SSI • Connection systems: Flying leads • Application: Drag chain operation, Zones with oils and lubricants 	DOL-1208-G10MAC1	6032868
	<ul style="list-style-type: none"> • Connection type head A: Female connector, M12, 8-pin, straight • Connection type head B: Flying leads • Signal type: Incremental, SSI • Cable: 20 m, 8-wire, PUR, halogen-free • Description: Incremental, shielded, SSI • Connection systems: Flying leads • Application: Drag chain operation, Zones with oils and lubricants 	DOL-1208-G20MAC1	6032869
	<ul style="list-style-type: none"> • Connection type head A: Female connector, M12, 8-pin, straight • Connection type head B: Flying leads • Signal type: Incremental, SSI • Cable: 25 m, 8-wire, PUR, halogen-free • Description: Incremental, shielded, SSI • Connection systems: Flying leads • Application: Drag chain operation, Zones with oils and lubricants 	DOL-1208-G25MAC1	6067859
	<ul style="list-style-type: none"> • Connection type head A: Female connector, M12, 8-pin, straight, A-coded • Signal type: Incremental, SSI • Cable: CAT5, CAT5e • Description: Incremental, shielded, SSI • Connection systems: IDC quick connection • Permitted cross-section: 0.14 mm² ... 0.34 mm² 	DOS-1208-GA01	6045001
	<ul style="list-style-type: none"> • Connection type head A: Flying leads • Connection type head B: Flying leads • Signal type: SSI, Incremental, HIPERFACE® • Items supplied: By the meter • Cable: 8-wire, PUR, halogen-free • Description: SSI, shielded, Incremental, HIPERFACE® 	LTG-2308-MWENC	6027529
	<ul style="list-style-type: none"> • Connection type head A: Flying leads • Connection type head B: Flying leads • Signal type: SSI, TTL, HTL, Incremental • Items supplied: By the meter • Cable: 12-wire, UV and saltwater-resistant, PUR, halogen-free • Description: SSI, shielded, TTL, HTL, Incremental 	LTG-2612-MW	6028516

SICK AT A GLANCE

SICK is one of the leading manufacturers of intelligent sensors and sensor solutions for industrial applications. A unique range of products and services creates the perfect basis for controlling processes securely and efficiently, protecting individuals from accidents and preventing damage to the environment.

We have extensive experience in a wide range of industries and understand their processes and requirements. With intelligent sensors, we can deliver exactly what our customers need. In application centers in Europe, Asia and North America, system solutions are tested and optimized in accordance with customer specifications. All this makes us a reliable supplier and development partner.

Comprehensive services complete our offering: SICK LifeTime Services provide support throughout the machine life cycle and ensure safety and productivity.

For us, that is “Sensor Intelligence.”

WORLDWIDE PRESENCE:

Contacts and other locations –www.sick.com