

# SICK

DAXSON-0300S1040901100

DAX

MAGNETOSTRICTIVE LINEAR ENCODERS

**SICK**  
Sensor Intelligence.



### Ordering information

Type	part no.
DAXSON-0300S1040901100	1132225

Illustration may differ

Other models and accessories → [www.sick.com/DAX](http://www.sick.com/DAX)



### Detailed technical data

#### Safety-related parameters

<b>MTTF<sub>D</sub> (mean time to dangerous failure)</b>	123 years <sup>1)</sup>
--	-------------------------

<sup>1)</sup> This product is a standard product and does not constitute a safety component as defined in the Machinery Directive. Calculation based on nominal load of components, average ambient temperature 40°C, frequency of use 8760 h/a. All electronic failures are considered hazardous. For more information, see document no. 8015532.

#### Performance

<b>Linearity</b>	≤ 0.02% F.S. (Minimum 250 μm) <sup>1) 2)</sup>
<b>Repeatability</b>	≤ ± 100 μm
<b>Measured values</b>	Positioning, speed
<b>Measuring range</b>	0 mm ... 300 mm
<b>Unusable range</b>	
Null zone	25 mm
Damping zone	63 mm
<b>Magnet type</b>	
Magnet shape	Slide magnet MAG-S-H29-01 (2129172)
Configured for number of magnets	1 piece
<b>Magnet travel speed</b>	≤ 10 m/s
<b>Resolution</b>	100 μm
<b>Cycle time</b>	1 ms

<sup>1)</sup> Systematic position measurement deviation according to DIN ISO 1319-1 (value includes all systematic errors or deviations from the actual position value, e.g. repeatability and hysteresis).

<sup>2)</sup> In principle, the size of the measurement deviation is limited by the resolution of the interface.

#### Interfaces

<b>Communication interface</b>	CANopen
<b>Data protocol</b>	Data protocol: CANopen CiA DS-301 V4.02, CiA DSP-305 LSS, Encoder Profile: - CiA DS-406, V3.2. - Class C2
<b>Address setting</b>	
Data transmission rate	10 kbit/s
Node ID	7Fh (127)

## Electronics

<b>Connection type</b>	Male connector, M12, 5-pin
<b>Pinouts</b>	1=n.c.; 2=V DC; 3=GND; 4=CAN_H; 5=CAN_L
<b>Male connector coding</b>	A-coded
<b>Supply voltage</b>	24 V DC (± 20%)
<b>Reverse polarity protection</b>	Up to -30 V DC
<b>Residual ripple</b>	≤ 0.28 V <sub>pp</sub>
<b>Dielectric strength</b>	500 V DC, 0 V against housing
<b>Over voltage protection</b>	≤ 36 V DC

## Mechanics

<b>Mechanical design</b>	DAX Slider
<b>Material</b>	
Housing	Aluminum (anodised), zinc, stainless steel, brass
Mounting bracket	Stainless steel 1.4301

## Ambient data

<b>EMC</b>	According to EN 61000-6-2 and EN 61000-6-4
<b>Enclosure rating</b>	IP65, IP67 <sup>1)</sup>
<b>Temperature</b>	
Operating temperature range	-40 °C ... +85 °C
Storage temperature range	-40 °C ... +85 °C
<b>Permissible relative humidity</b>	90 % (Condensation not permitted)
<b>Resistance to shocks</b>	100 g, 6 ms (IEC 60068-2-27)
<b>Resistance to vibration</b>	15 g / 10...2,000 Hz according to IEC 60068-2-6

<sup>1)</sup> In correctly assembled mating connector.

## General notes

<b>Items supplied</b>	
	Mounting brackets enclosed, mounting material for base not included. Position magnet not included.

## Classifications

<b>ECLASS 5.0</b>	27270705
<b>ECLASS 5.1.4</b>	27270705
<b>ECLASS 6.0</b>	27270705
<b>ECLASS 6.2</b>	27270705
<b>ECLASS 7.0</b>	27270705
<b>ECLASS 8.0</b>	27270705
<b>ECLASS 8.1</b>	27270705
<b>ECLASS 9.0</b>	27270705
<b>ECLASS 10.0</b>	27270705
<b>ECLASS 11.0</b>	27270705
<b>ECLASS 12.0</b>	27274304

<b>ETIM 5.0</b>	EC002544
<b>ETIM 6.0</b>	EC002544
<b>ETIM 7.0</b>	EC002544
<b>ETIM 8.0</b>	EC002544
<b>UNSPSC 16.0901</b>	41111613

### Certificates

<b>EU declaration of conformity</b>	✓
<b>UK declaration of conformity</b>	✓
<b>ACMA declaration of conformity</b>	✓
<b>Moroccan declaration of conformity</b>	✓
<b>China RoHS</b>	✓
<b>cULus certificate</b>	✓
<b>Information according to Art. 3 of Data Act (Regulation EU 2023/2854)</b>	✓

### distance of position magnets

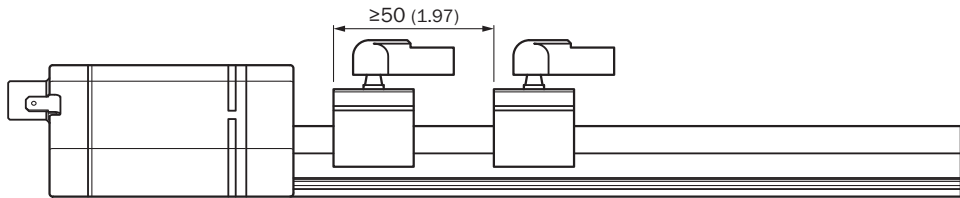

Dimensions in mm (inch)

### DAX Slider

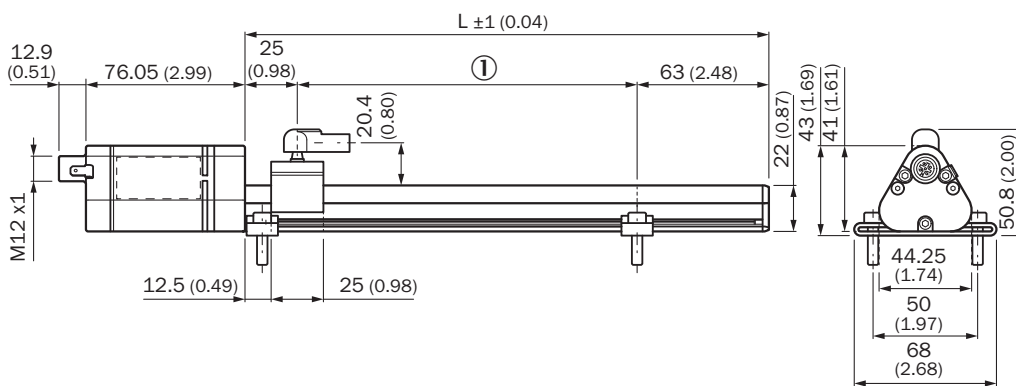

Dimensions in mm (inch)

① Measuring range

slide magnet MAG-S-H29-01 (2129172)



Dimensions in mm (inch)

positioning of mounting bracket



Dimensions in mm (inch)

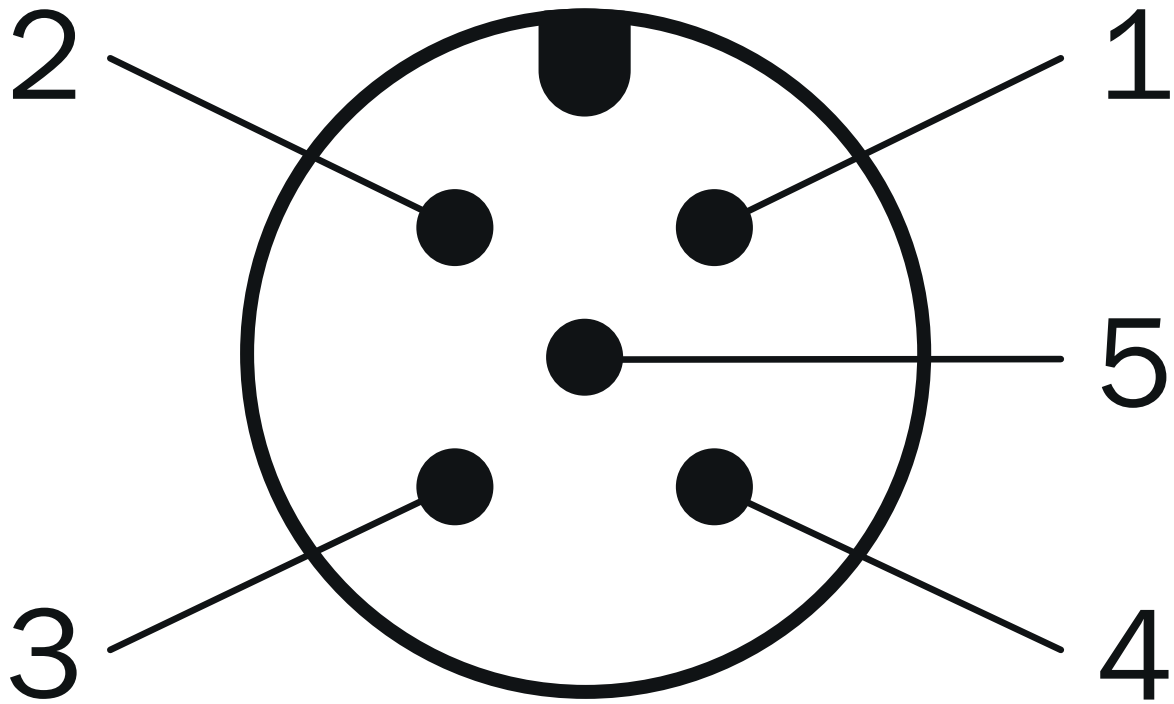

Anschlussbelegung



M12 male connector, 5-pin	Signal
1	n.c.
2	V DC
3	GND
4	CAN_H
5	CAN_L

## Recommended accessories

Other models and accessories → [www.sick.com/DAX](http://www.sick.com/DAX)

	Brief description	Type	part no.
Mounting systems			
	<ul style="list-style-type: none"> <li><b>Description:</b> Replacement clamping bracket for DAX® Slider without fastening material</li> <li><b>Dimensions (W x H x L):</b> 15 mm x 9.49 mm x 68 mm</li> <li><b>Color:</b> Metallic</li> <li><b>Items supplied:</b> 2 pieces</li> </ul>	BEF-KH-SL1-02	2125240
	<ul style="list-style-type: none"> <li><b>Description:</b> Replacement clamping bracket for DAX® Slider without fastening material</li> <li><b>Dimensions (W x H x L):</b> 15 mm x 9.49 mm x 68 mm</li> <li><b>Color:</b> Metallic</li> <li><b>Items supplied:</b> 3 pieces</li> </ul>	BEF-KH-SL1-03	2125241
	<ul style="list-style-type: none"> <li><b>Description:</b> Replacement clamping bracket for DAX® Slider without fastening material</li> <li><b>Dimensions (W x H x L):</b> 15 mm x 9.49 mm x 68 mm</li> <li><b>Color:</b> Metallic</li> <li><b>Items supplied:</b> 4 pieces</li> </ul>	BEF-KH-SL1-04	2125242

	Brief description	Type	part no.
connectors and cables			
	<ul style="list-style-type: none"> <li><b>Connection type head A:</b> Female connector, M12, 5-pin, straight, A-coded</li> <li><b>Connection type head B:</b> Male connector, M12, 5-pin, straight, A-coded</li> <li><b>Signal type:</b> Fieldbus, CANopen, DeviceNet™</li> <li><b>Cable:</b> 10 m, 4-wire, PUR, halogen-free</li> <li><b>Description:</b> Fieldbus, shielded, CANopen, DeviceNet™</li> <li><b>Application:</b> Drag chain operation, Zones with oils and lubricants</li> </ul>	YF2A15-100C1B-M2A15	2106282
	<ul style="list-style-type: none"> <li><b>Connection type head A:</b> Female connector, M12, 5-pin, straight, A-coded</li> <li><b>Connection type head B:</b> Flying leads</li> <li><b>Signal type:</b> Fieldbus, CANopen, DeviceNet™</li> <li><b>Cable:</b> 10 m, 4-wire, PUR, halogen-free</li> <li><b>Description:</b> Fieldbus, shielded, CANopen, DeviceNet™</li> <li><b>Application:</b> Drag chain operation, Zones with oils and lubricants</li> </ul>	YF2A15-100C1BXLEAX	2106286
	<ul style="list-style-type: none"> <li><b>Description:</b> CANopen, unshielded</li> <li><b>Connection type head A:</b> Male connector, M12, 5-pin, straight</li> <li><b>Signal type:</b> CANopen</li> </ul>	CAN male connector	6021167
	<ul style="list-style-type: none"> <li><b>Description:</b> CANopen, shielded, DeviceNet™</li> <li><b>Connection type head A:</b> Female connector, M12, 5-pin, straight, A-coded</li> <li><b>Signal type:</b> CANopen, DeviceNet™</li> <li><b>Connection systems:</b> Screw-type terminals</li> <li><b>Permitted cross-section:</b> ≤ 0.75 mm<sup>2</sup></li> </ul>	DOS-1205-GA	6027534
	<ul style="list-style-type: none"> <li><b>Description:</b> Unshielded, for simultaneous connection to sender and receiver, splits the cable from the control cabinet to the sender and receiver</li> <li><b>Connection type head A:</b> Female connector, M12, 5-pin, A-coded</li> <li><b>Connection type head B:</b> Female connector, M12, 5-pin, A-coded</li> <li><b>Connection type head C:</b> Male connector, M12, 5-pin, A-coded</li> </ul>	DSC-1205T000025KMC	6030664
	<ul style="list-style-type: none"> <li><b>Description:</b> CANopen, shielded, DeviceNet™</li> <li><b>Connection type head A:</b> Flying leads</li> <li><b>Connection type head B:</b> Flying leads</li> <li><b>Signal type:</b> CANopen, DeviceNet™</li> <li><b>Items supplied:</b> By the meter</li> <li><b>Cable:</b> 4-wire, twisted pair</li> <li><b>Note:</b> Wire shield Al-Pt film, overall shield C-screen tin-plated</li> </ul>	LTG-2804-MW	6028328
	<ul style="list-style-type: none"> <li><b>Description:</b> CANopen, shielded, DeviceNet™</li> <li><b>Connection type head A:</b> Male connector, M12, 5-pin, straight, A-coded</li> <li><b>Signal type:</b> CANopen, DeviceNet™</li> <li><b>Connection systems:</b> Screw-type terminals</li> <li><b>Permitted cross-section:</b> ≤ 0.75 mm<sup>2</sup></li> </ul>	STE-1205-GA	6027533
	<ul style="list-style-type: none"> <li><b>Connection type head A:</b> Female connector, M12, 5-pin, straight, A-coded</li> <li><b>Connection type head B:</b> Male connector, M12, 5-pin, straight, A-coded</li> <li><b>Signal type:</b> Fieldbus, CANopen, DeviceNet™</li> <li><b>Cable:</b> 2 m, 4-wire, PUR, halogen-free</li> <li><b>Description:</b> Fieldbus, shielded, CANopen, DeviceNet™</li> <li><b>Application:</b> Drag chain operation, Zones with oils and lubricants</li> </ul>	YF2A15-020C1B-M2A15	2106279
	<ul style="list-style-type: none"> <li><b>Connection type head A:</b> Female connector, M12, 5-pin, straight, A-coded</li> <li><b>Connection type head B:</b> Flying leads</li> <li><b>Signal type:</b> Fieldbus, CANopen, DeviceNet™</li> <li><b>Cable:</b> 2 m, 4-wire, PUR, halogen-free</li> <li><b>Description:</b> Fieldbus, shielded, CANopen, DeviceNet™</li> <li><b>Application:</b> Drag chain operation, Zones with oils and lubricants</li> </ul>	YF2A15-020C1BXLEAX	2106283
	<ul style="list-style-type: none"> <li><b>Connection type head A:</b> Female connector, M12, 5-pin, straight, A-coded</li> <li><b>Connection type head B:</b> Male connector, M12, 5-pin, straight, A-coded</li> <li><b>Signal type:</b> Fieldbus, CANopen, DeviceNet™</li> <li><b>Cable:</b> 5 m, 4-wire, PUR, halogen-free</li> <li><b>Description:</b> Fieldbus, shielded, CANopen, DeviceNet™</li> <li><b>Application:</b> Drag chain operation, Zones with oils and lubricants</li> </ul>	YF2A15-050C1B-M2A15	2106281
	<ul style="list-style-type: none"> <li><b>Connection type head A:</b> Female connector, M12, 5-pin, straight, A-coded</li> <li><b>Connection type head B:</b> Flying leads</li> <li><b>Signal type:</b> Fieldbus, CANopen, DeviceNet™</li> <li><b>Cable:</b> 5 m, 4-wire, PUR, halogen-free</li> <li><b>Description:</b> Fieldbus, shielded, CANopen, DeviceNet™</li> <li><b>Application:</b> Drag chain operation, Zones with oils and lubricants</li> </ul>	YF2A15-050C1BXLEAX	2106284
	<ul style="list-style-type: none"> <li><b>Description:</b> Shielded, for cascading several devices via the CAN connection</li> <li><b>Connection type head A:</b> Female connector, M12, 5-pin, A-coded</li> <li><b>Connection type head B:</b> Female connector, M12, 5-pin, A-coded</li> </ul>	Y-CAN cable	6083185

	Brief description	Type	part no.
	<ul style="list-style-type: none"> <li>• <b>Connection type head C:</b> Male connector, M12, 5-pin, A-coded</li> <li>• <b>Cable:</b> 0.5 m, TPU</li> </ul>		
magnets			
	<ul style="list-style-type: none"> <li>• <b>Product segment:</b> Magnets</li> <li>• <b>Product:</b> Position magnets</li> <li>• <b>Description:</b> Slide magnet for magnetostrictive linear encoders</li> </ul>	MAG-S-H29-01	2129172

## SICK AT A GLANCE

SICK is one of the leading manufacturers of intelligent sensors and sensor solutions for industrial applications. A unique range of products and services creates the perfect basis for controlling processes securely and efficiently, protecting individuals from accidents and preventing damage to the environment.

We have extensive experience in a wide range of industries and understand their processes and requirements. With intelligent sensors, we can deliver exactly what our customers need. In application centers in Europe, Asia and North America, system solutions are tested and optimized in accordance with customer specifications. All this makes us a reliable supplier and development partner.

Comprehensive services complete our offering: SICK LifeTime Services provide support throughout the machine life cycle and ensure safety and productivity.

For us, that is “Sensor Intelligence.”

## WORLDWIDE PRESENCE:

Contacts and other locations –[www.sick.com](http://www.sick.com)