



RSB1-0685D137137FZ4BZZZP0D

Roller Sensor Bar

PHOTOELECTRIC SENSORS

SICK
Sensor Intelligence.



Illustration may differ



Ordering information

| Type | part no. |
|----------------------------|----------|
| RSB1-0685D137137FZ4BZZZPOD | 1131720 |

Included in delivery: BEF-AP-RSBCON (1)

Other models and accessories → www.sick.com/Roller_Sensor_Bar

Detailed technical data

Features

| | |
|---|---|
| Functional principle | Photoelectric proximity sensor |
| Functional principle detail | Energetic |
| Sensing range | |
| Sensing range min. | 2 mm |
| Sensing range max. | 300 mm |
| Reference object | Object with 90% remission factor (complies with standard white according to DIN 5033) |
| Recommended sensing range for the best performance | 2 mm ... 45 mm |
| Emitted beam | |
| Light source | LED |
| Type of light | Infrared light |
| Shape of light spot | Point-shaped |
| Light spot size (distance) | 27 mm x 29 mm (45 mm) |
| Maximum dispersion of the emitted beam around the standardized transmission axis (squint angle) | < +/- 4° (at T _a = +23 °C) |
| Key LED figures | |
| LED risk group marking | Free group |
| Wave length | 850 nm |
| Average service life | 100,000 h at T _a = +25 °C |
| Number of beams | 4 |
| Beam separation | 137 mm |
| Distance from 1st beam to leading edge of housing (including end cap) | 137 mm |
| Smallest detectable object (MDO) typ. | |
| | 137 mm, Dependent on distance between beams |
| Adjustment | |
| None | - |
| Display | |

| | | |
|-----------------------------|------------|---|
| | LED green | Operating indicator Static on: power on |
| | LED yellow | Status of received light beam Static on: object present Static off: object not present |
| Special applications | | Detecting flat objects, Detecting perforated objects, Detecting objects with position tolerances, Detecting uneven, shiny objects |

Electronics

| | | |
|--|-------------------------------|--|
| Supply voltage U_B | | 10 V DC ... 30 V DC |
| Ripple | | $\leq 5 V_{pp}$ |
| Usage category | | DC-12 (According to EN 60947-5-2) DC-13 (According to EN 60947-5-2) |
| Current consumption | | 17 mA, without load. At $U_B = 24 V$ |
| Protection class | | III |
| Digital output | | |
| | Number | 1 |
| | Type | PNP |
| | Switching mode | Dark switching |
| | Signal voltage PNP HIGH/LOW | Approx. $U_B - 2.5 V / 0 V$ |
| | Output current I_{max} | $\leq 100 mA$ |
| | Circuit protection outputs | Reverse polarity protected Overcurrent protected Short-circuit protected |
| | Response time | $\leq 1 ms$ ¹⁾ |
| | Repeatability (response time) | 1 ms |
| | Switching frequency | 500 Hz ²⁾ |
| Pin/Wire assignment | | |
| | BN 1 | + (L+) |
| | WH 2 | Q_2 |
| | BU 3 | - (M) |
| | BK 4 | Q_1 |
| | Function of pin 4/black (BK) | Digital output, dark switching, object present → output LOW |

¹⁾ Signal transit time with resistive load.

²⁾ With light/dark ratio 1:1.

Mechanics

| | | |
|-------------------------------|----------------------|---|
| Dimensions (W x H x D) | | 685 mm x 20.3 mm x 17 mm ¹⁾ |
| Connection | | Cable with connector M12, 4-pin, with knurled nut ²⁾ |
| Connection detail | | |
| | Deep-freeze property | Do not bend below 0 °C |
| | Conductor size | 0.13 mm ² |
| | Cable diameter | Ø 3.6 mm |

¹⁾ W = length of Roller Sensor Bar (in the installed state).

²⁾ Due to the manufacturing process, the cable can be a little longer.

| | | |
|-----------------------------|---|----------------------------|
| Length of cable (L) | 150 mm ²⁾ | |
| Material | Housing | Metal, Aluminum (anodised) |
| | Front screen | Plastic, PMMA |
| | Cable | Plastic, PVC |
| | Male connector | Plastic, PVC |
| Weight | Approx. 248.6 g | |
| Mounting system type | BEF-AP-RSBCON, adapter bracket to snap between hex sections | |

¹⁾ W = length of Roller Sensor Bar (in the installed state).

²⁾ Due to the manufacturing process, the cable can be a little longer.

Ambient data

| | |
|--|---|
| Enclosure rating | IP67 (EN 60529) |
| Ambient operating temperature | -40 °C ... +60 °C |
| Ambient temperature, storage | -40 °C ... +75 °C |
| Shock resistance | 30 g, 11 ms (3 positive and 3 negative shocks along X, Y, Z axes, 18 total shocks (EN60068-2-27)) |
| Vibration resistance | 10 Hz ... 55 Hz (Amplitude 1 mm, 3 x 30 min (EN60068-2-6)) |
| Air humidity | 15 % ... 95 %, relative humidity (no condensation), as per IEC 60947-5-2 |
| Electromagnetic compatibility (EMC) | EN 60947-5-2 |
| UL File No. | NRKH.E189383 & NRKH7.E189383 |

Certificates

| | |
|---------------------------------------|---|
| EU declaration of conformity | ✓ |
| UK declaration of conformity | ✓ |
| ACMA declaration of conformity | ✓ |
| China RoHS | ✓ |
| cULus certificate | ✓ |

Classifications

| | |
|---------------------|----------|
| ECLASS 5.0 | 27270904 |
| ECLASS 5.1.4 | 27270904 |
| ECLASS 6.0 | 27270904 |
| ECLASS 6.2 | 27270904 |
| ECLASS 7.0 | 27270904 |
| ECLASS 8.0 | 27270904 |
| ECLASS 8.1 | 27270904 |
| ECLASS 9.0 | 27270904 |
| ECLASS 10.0 | 27270904 |
| ECLASS 11.0 | 27270904 |
| ECLASS 12.0 | 27270903 |
| ETIM 5.0 | EC002719 |
| ETIM 6.0 | EC002719 |
| ETIM 7.0 | EC002719 |

| | |
|-----------------------|----------|
| ETIM 8.0 | EC002719 |
| UNSPSC 16.0901 | 39121528 |

Dimensional drawing

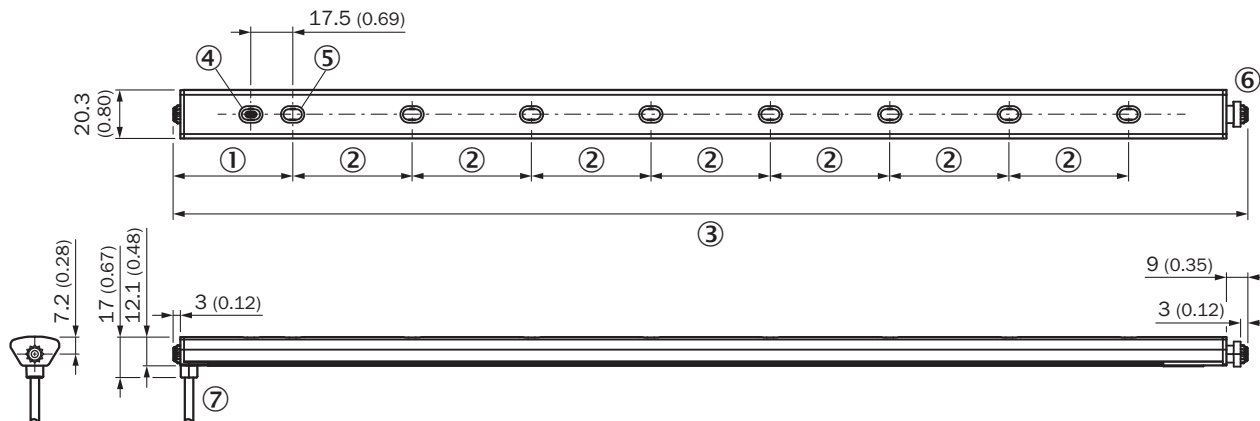

Dimensions in mm (inch)

- ① Distance from 1st beam to leading edge of housing (including end cap)
- ② Beam separation
- ③ length of Roller Sensor Bar (in the installed state)
- ④ display and adjustment elements
- ⑤ First beam (number of beams varies depending on the variant)
- ⑥ Spring loaded end cap (for further information see the installation note)
- ⑦ Connection

display and adjustment elements



- ① LED green
- ② LED yellow

Installation note



- ⑥ Range of motion of the spring loaded end cap (up to 5 mm of compression in uninstalled state)

Connection type M12 male connector, 4-pin



Characteristic curve

Operating reserve



Recommended sensing range for the best performance

- ① Black object, 6% remission factor
- ② Gray object, 18% remission factor
- ③ White object, 90% remission factor

Light spot size

Dimensions in mm (inch)



Recommended sensing range for the best performance

Light spot size

mm (inch)



- ① Black object, 6% remission factor
- ② Gray object, 18% remission factor
- ③ White object, 90% remission factor

Recommended accessories

Other models and accessories → www.sick.com/Roller_Sensor_Bar

| | Brief description | Type | part no. |
|---|--|--------------------|----------|
| Mounting systems | | | |
|  | <ul style="list-style-type: none"> Description: 8 mm round adapter bracket with adhesive back | BEF-AP-RSBADHA | 2127765 |
|  | <ul style="list-style-type: none"> Description: Adapter bracket with adhesive back | BEF-AP-RSBADHB | 2127766 |
|  | <ul style="list-style-type: none"> Description: Adapter bracket to snap between hex sections | BEF-AP-RSBCON | 2127768 |
|  | <ul style="list-style-type: none"> Description: Hex adapter bracket | BEF-AP-RSBHEX | 2127767 |
|  | <ul style="list-style-type: none"> Description: Adapter kit: BEF-AP-RSBADHA, BEF-AP-RSBADHB, BEF-AP-RSBCON, BEF-AP-RSBHEX Items supplied: BEF-AP-RSBADHA, BEF-AP-RSBADHB, BEF-AP-RSBCON, BEF-AP-RSBHEX | BEF-AP-RSBKIT | 2127759 |
| connectors and cables | | | |
|  | <ul style="list-style-type: none"> Description: Unshielded Connection type head A: Male connector, M12, 4-pin, straight, A-coded Connection systems: Screw-type terminals Permitted cross-section: ≤ 0.75 mm² | STE-1204-G | 6009932 |
|  | <ul style="list-style-type: none"> Description: Sensor/actuator cable, unshielded Connection type head A: Female connector, M12, 4-pin, straight, A-coded Connection type head B: Flying leads Signal type: Sensor/actuator cable Cable: 5 m, 4-wire, PUR, halogen-free Application: Drag chain operation, Zones with oils and lubricants, Robot, Drag chain operation | YF2A14-050UB3XLEAX | 2095608 |
|  | <ul style="list-style-type: none"> Description: Sensor/actuator cable, unshielded Connection type head A: Female connector, M12, 4-pin, straight, A-coded Connection type head B: Flying leads Signal type: Sensor/actuator cable Cable: 5 m, 4-wire, PVC Application: Uncontaminated zones, Zones with chemicals | YF2A14-050VB3XLEAX | 2096235 |

SICK AT A GLANCE

SICK is one of the leading manufacturers of intelligent sensors and sensor solutions for industrial applications. A unique range of products and services creates the perfect basis for controlling processes securely and efficiently, protecting individuals from accidents and preventing damage to the environment.

We have extensive experience in a wide range of industries and understand their processes and requirements. With intelligent sensors, we can deliver exactly what our customers need. In application centers in Europe, Asia and North America, system solutions are tested and optimized in accordance with customer specifications. All this makes us a reliable supplier and development partner.

Comprehensive services complete our offering: SICK LifeTime Services provide support throughout the machine life cycle and ensure safety and productivity.

For us, that is “Sensor Intelligence.”

WORLDWIDE PRESENCE:

Contacts and other locations –www.sick.com