



RFU610-10705

RFU61x

RFID

SICK
Sensor Intelligence.



Ordering information

Type	part no.
RFU610-10705	1130197

Included in delivery: Mounting kit (1)

Other models and accessories → www.sick.com/RFU61x



Detailed technical data

Features

Version	Short Range
Product category	RFID read/write device with integrated antenna
Radio approval	China
Frequency band	UHF (860 MHz ... 960 MHz)
Carrier frequency	920.625 MHz ... 924.375 MHz
Output power	25 mW (ERP, 14 dBm)
RFID standard	EPCglobal UHF Class 1 Generation 2, ISO/IEC 18000-6 C, RAIN
Modulation	PR-ASK
Connection type	IO-Link
Aperture angle	110°
Reading range	≤ 0.5 m ¹⁾
Antenna	Integrated
Transmitting power	Adjustable
Polarization	Circular
Axial ratio	Typ. 2 dB
Front-to-back ratio	> 5 dB

¹⁾ Depending on transponder used and ambient conditions.

Mechanics/electronics

Connection type	1 x M12, 4-pin male connector, A-coded 1 x M8, 4-pin socket 1 x USB, 5-pin micro-B socket
Supply voltage	18 V DC ... 30 V DC
Power consumption	6 W, standby 3 W
Housing material	Aluminum die cast Plastic (PPS)
Enclosure rating	IP67

¹⁾ Operation at +50 °C.

Protection class	III
Weight	313 g
Dimensions (L x W x H)	92 mm x 80 mm x 38 mm
MTBF	22.25 years ¹⁾

¹⁾ Operation at +50 °C.

Interfaces

IO-Link	✓ , IO-Link V1.1
Remark	Process data length: IN (input), 32 bytes; OUT (output), 32 bytes, SIO mode not supported
Function	Process data, parameterization, diagnosis
Data transmission rate	COM3 (230,4 kBaud)
Digital inputs	1 (physical, switching, trigger sensor can be connected directly to the device (port 3))
Optical indicators	4 LEDs, multi-color (device status) 4 RGB LED (Process feedback)
Configuration software	PLC software SOPAS ET ¹⁾
Memory card	Micro SD memory card

¹⁾ In combination with SiLink2 Master or SIG200.

Ambient data

Electromagnetic compatibility (EMC)	EN 301489-1 V2.1.1 (2017) / EN 301489-3 V1.6.1 (2013)
Vibration resistance	IEC 60068-2-6:2007 IEC 60068-2-64:2008
Shock resistance	EN 60068-2-27:2008
Ambient operating temperature	-25 °C ... +50 °C
Storage temperature	-40 °C ... +70 °C
Relative humidity	90 %, Non-condensing

Certificates

China RoHS	✓
Radio Approval certificate China	✓
RAIN RFID	✓

Classifications

ECLASS 5.0	27280401
ECLASS 5.1.4	27280401
ECLASS 6.0	27280401
ECLASS 6.2	27280401
ECLASS 7.0	27280401
ECLASS 8.0	27280401
ECLASS 8.1	27280401
ECLASS 9.0	27280401
ECLASS 10.0	27280401
ECLASS 11.0	27280401
ECLASS 12.0	27280401

ETIM 5.0	EC002998
ETIM 6.0	EC002998
ETIM 7.0	EC002998
ETIM 8.0	EC002998
UNSPSC 16.0901	52161523

Dimensional drawing

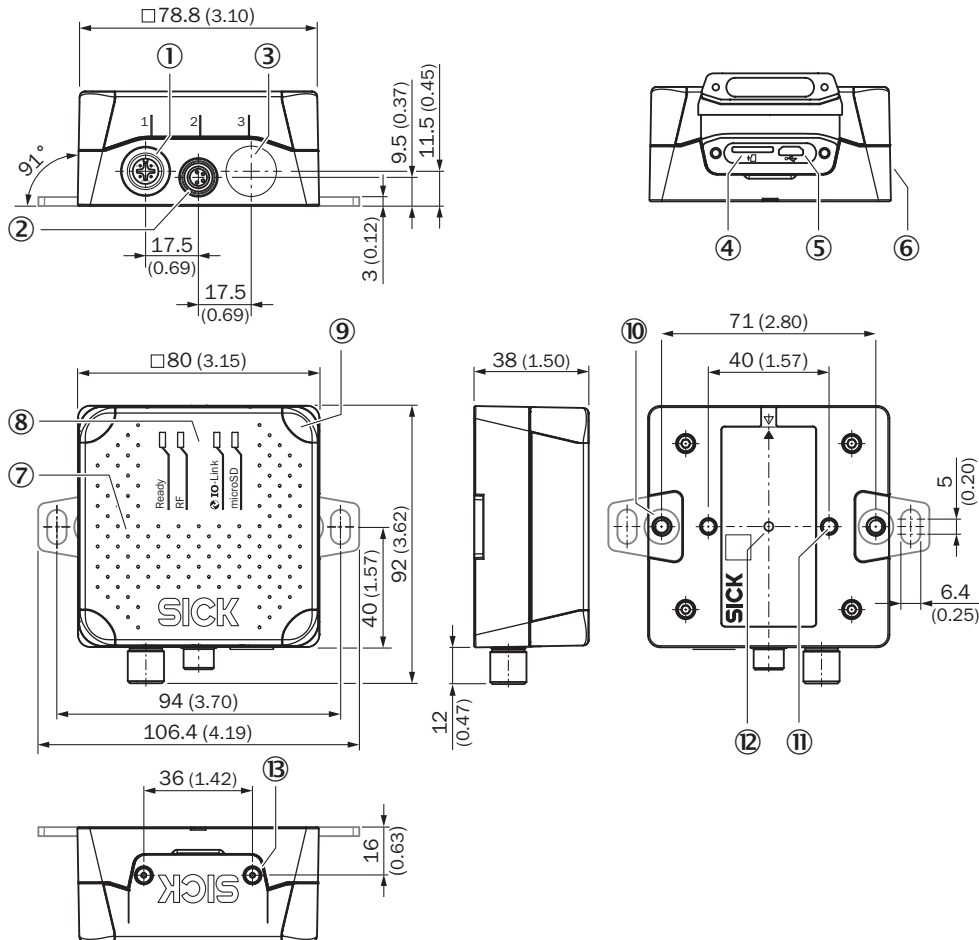

Dimensions in mm (inch)

- ① Connection 1: IO-Link (male connector, M12, 4-pin, A-coded)
- ② Connection 2: Trigger (female connector, M8, 4-pin, coded)
- ③ Dummy plug
- ④ Slot for microSD memory card
- ⑤ "USB" connection (female connector, 5-pin, type Micro-B) interface for temporary use (service)
- ⑥ Side type label
- ⑦ cover with integrated antenna
- ⑧ 4 x multi-colored LED (status)
- ⑨ 4 x multi-colored LED (process feedback)
- ⑩ 2 x M5 blind tapped holes, 6 mm deep for attaching the mounting straps
- ⑪ 2 x M5 blind tapped holes, 7 mm deep for mounting the device
- ⑫ type label with integrated pressure compensation membrane
- ⑬ 2 x screw (M2,5 socket screw), captive, for side cover

Radiation pattern

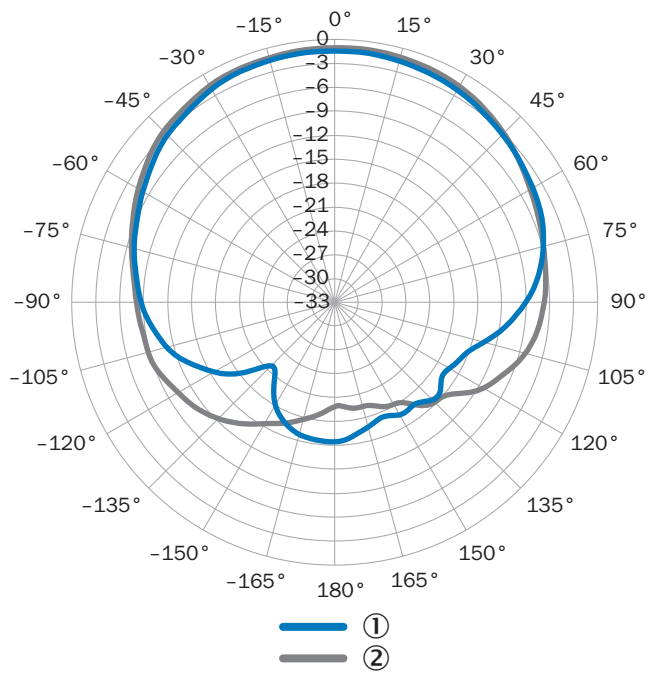

PIN assignment IO-Link connection

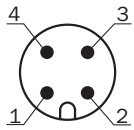





IO-Link connection (male connector, M12, 4-pin, A-coded)

- ① L+
- ② Reserved
- ③ L-
- ④ C/Q1

Recommended accessories

Other models and accessories → www.sick.com/RFU61x

	Brief description	Type	part no.
Photoelectric sensors			
	<ul style="list-style-type: none"> • Sensing range max.: 0.03 m ... 6 m • Functional principle: Photoelectric retro-reflective sensor • Connection type: Male connector M8, 4-pin • Type of light: Visible red light • Adjustment: Potentiometer • Housing: Rectangular 	GL6-P4211	1059241
reflectors and optics			
	<ul style="list-style-type: none"> • Description: Rectangular, screw connection • Dimensions: 51 mm 61 mm • Ambient operating temperature: -30 °C ... +65 °C 	P250	5304812
network devices			
		SIG200-0A0412200	1089794
connectors and cables			
	<ul style="list-style-type: none"> • Description: Sensor/actuator cable, unshielded • Connection type head A: Female connector, M12, 4-pin, straight, A-coded • Connection type head B: Male connector, M12, 4-pin, straight, A-coded • Signal type: Sensor/actuator cable • Cable: 0.6 m, 4-wire, PUR, halogen-free • Application: Drag chain operation, Zones with oils and lubricants, Robot, Drag chain operation 	YF2A14-C60UB3M2A14	2095999

SICK AT A GLANCE

SICK is one of the leading manufacturers of intelligent sensors and sensor solutions for industrial applications. A unique range of products and services creates the perfect basis for controlling processes securely and efficiently, protecting individuals from accidents and preventing damage to the environment.

We have extensive experience in a wide range of industries and understand their processes and requirements. With intelligent sensors, we can deliver exactly what our customers need. In application centers in Europe, Asia and North America, system solutions are tested and optimized in accordance with customer specifications. All this makes us a reliable supplier and development partner.

Comprehensive services complete our offering: SICK LifeTime Services provide support throughout the machine life cycle and ensure safety and productivity.

For us, that is “Sensor Intelligence.”

WORLDWIDE PRESENCE:

Contacts and other locations –www.sick.com