



M4P-SA04300A00

deTem

SAFETY MULTIBEAM SENSORS

SICK
Sensor Intelligence.



Ordering information

Type	part no.
M4P-SA04300A00	1128429

Other models and accessories → www.sick.com/deTem

Illustration may differ



Detailed technical data

Features

Product version	deTem4
Application	Normal industrial environment
Functional principle	Sender/receiver
System part	Sender
Scanning range	90 m
Number of beams	4
Beam separation	300 mm
Synchronization	Optical synchronization
Items supplied	Sender

Safety-related parameters

Type	Type 4 (IEC 61496)
Safety integrity level	SIL 3 (IEC 61508, IEC 62061)
Category	Category 4 (ISO 13849)
Performance level	PL e (ISO 13849)
PFH_D (mean probability of a dangerous failure per hour)	6.6×10^{-9}
T_M (mission time)	20 years (ISO 13849)
Safe state in the event of a fault	At least one OSSD is in the OFF state.

Functions

Note	The deTem4 safety light-beam sensor can be used with different function packages. The function packages are determined by the equipment used.
Function package SP1	Protective operation Beam coding Restart interlock External device monitoring (EDM)

	Application diagnostic output (ADO) IO-Link Equipment: Sender and receiver with SP1 system plug
Function package SP2	Function package SP1 included Manual adjustment of the protective field width Muting (2-signal muting) Partial muting Equipment: Sender with SP1 system plug and receiver with SP2 system plug
Function package DMM4	Function package SP2 included Transmitting power adjustment Muting (4-signal muting) Operating mode selection Inputs for safety sensors (SDI) Equipment: Sender and receiver with SP1 system plug and DMM4 extension module

Interfaces

System connection	Depending on system plug (M12 male connector, 5-pin or 8-pin)
Configuration method	DIP switch on system plug PC software via DMM4 (Safety Designer)
Display elements	Status LEDs

Electronics

Protection class	III (IEC 61140) ¹⁾
Supply voltage V_S	24 V DC (19.2 V DC ... 28.8 V DC) ²⁾
Residual ripple	$\leq 10\%$ ³⁾

¹⁾ The system must be supplied with SELV/PELV in accordance with IEC 60204-1.

²⁾ The external voltage supply must be capable of buffering brief mains voltage failures of 20 ms as specified in EN 60204-1. Suitable power supplies are available as accessories from SICK.

³⁾ Within the limits of V_S .

Mechanics

Dimensions	See dimensional drawing
Housing cross-section	30.7 mm x 34 mm
Material	
Housing	Aluminum extruded profile
Front screen	Polycarbonate, scratch-resistant coating

Ambient data

Enclosure rating	IP65 (IEC 60529) IP67 (IEC 60529)
Ambient operating temperature	-30 °C ... +55 °C
Storage temperature	-30 °C ... +70 °C
Air humidity	15 % ... 95 %, Non-condensing
Vibration resistance	5 ... 150 Hz, 3,5 mm / 1 g (EN 60068-2-6)
Shock resistance	15 g / 6 ms (EN 60068-2-27)
Class	3M4 (IEC TR 60721-4-3)
EMC	According to IEC 61496-1, IEC 61000-6-2, IEC 61000-6-4

Other information

Type of light	Near-infrared (NIR), invisible
Wave length	850 nm

Certificates

EU declaration of conformity	✓
UK declaration of conformity	✓
ACMA declaration of conformity	✓
Moroccan declaration of conformity	✓
China RoHS	✓
ULus approval	✓
cUL approval	✓
EC-Type-Examination approval	✓
Information according to Art. 3 of Data Act (Regulation EU 2023/2854)	✓

Classifications

ECLASS 5.0	27272703
ECLASS 5.1.4	27272703
ECLASS 6.0	27272703
ECLASS 6.2	27272703
ECLASS 7.0	27272703
ECLASS 8.0	27272703
ECLASS 8.1	27272703
ECLASS 9.0	27272703
ECLASS 10.0	27272703
ECLASS 11.0	27272703
ECLASS 12.0	27272703
ETIM 5.0	EC001832
ETIM 6.0	EC001832
ETIM 7.0	EC001832
ETIM 8.0	EC001832
UNSPSC 16.0901	46171620

Dimensional drawing

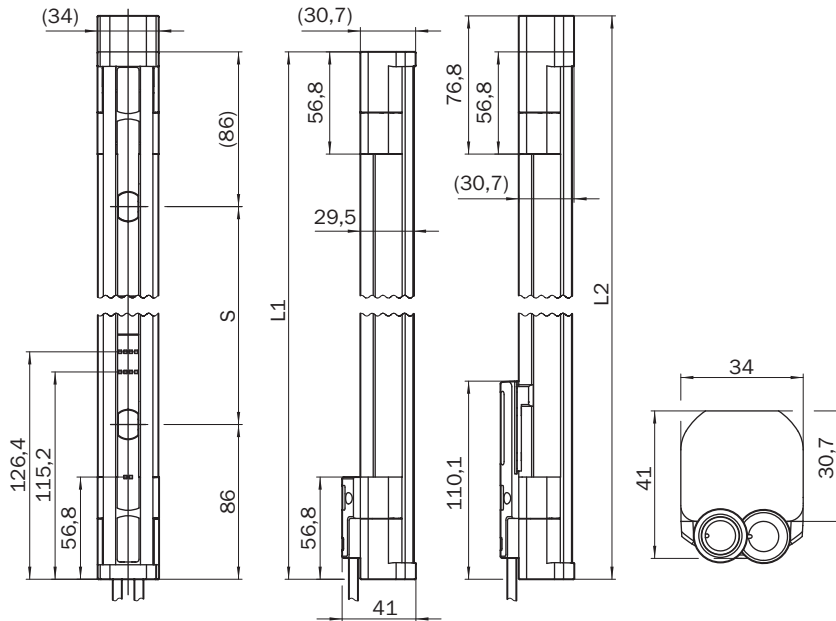

Dimensions in mm (inch)

Number of beams	Beam separation S	L1 (height without top LED)	L2 (height with top LED)
1	-	313	-
2	500	672	692
3	400	972	992
4	300	1072	1092

Connection diagram deTec4 / deTem4 on DMM4, connection example, muting, reset, override, SDI



E416641/00/2024-12-20

The requirements in the operating instructions of the devices used must be adhered to.

Connection diagram deTec4 / deTem4 on DMM4, muting, reset, override, operating mode selection

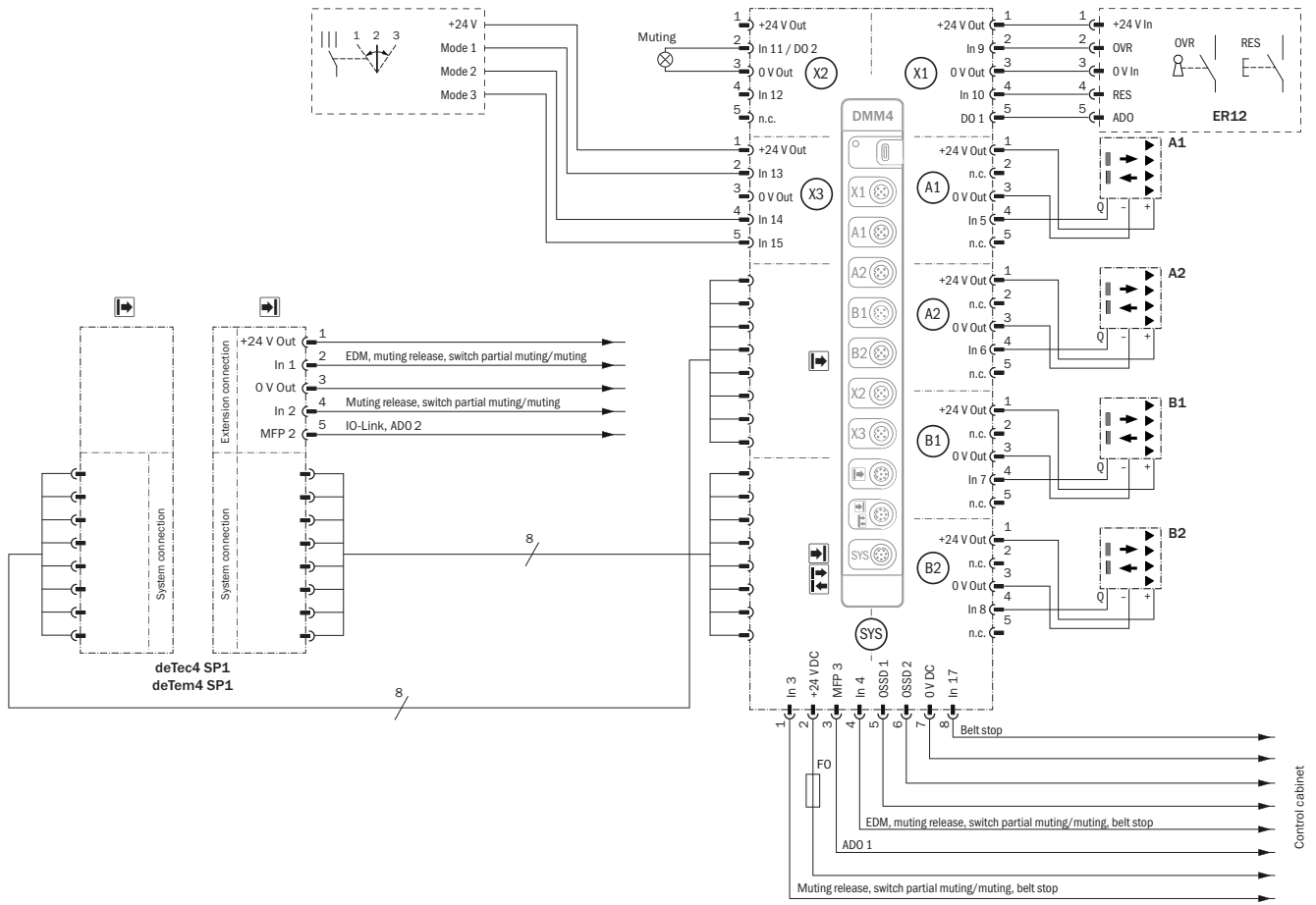

E416642/00/2024-12-20

The requirements in the operating instructions of the devices used must be adhered to.

Recommended accessories

Other models and accessories → www.sick.com/deTem

	Brief description	Type	part no.
Mounting systems			
	<ul style="list-style-type: none"> Description: QuickFix bracket for 2 devices (e.g. sender and receiver) Material: Plastic Details: Plastic Packing unit: 4 pieces 	BEF-3SHABPKU4	2098710
	<ul style="list-style-type: none"> Description: FlexFix bracket for 2 devices (e.g. sender and receiver), can be aligned $\pm 15^\circ$, including M5 screw Material: Plastic Details: Plastic Packing unit: 4 pieces 	BEF-1SHABPKU4	2066614
	<ul style="list-style-type: none"> Description: Muting arm bracket for deTec safety light curtain or deTem safety multibeam sensor Packing unit: 1 piece Suitable for: deTec, deTem 	Muting arm bracket	2106455
	<ul style="list-style-type: none"> Description: Muting arm, short Suitable for: deTec, deTem 	Muting arm, short	2111924
	<ul style="list-style-type: none"> Description: Muting arm, long Suitable for: deTec, deTem 	Muting arm, long	2111923

SICK AT A GLANCE

SICK is one of the leading manufacturers of intelligent sensors and sensor solutions for industrial applications. A unique range of products and services creates the perfect basis for controlling processes securely and efficiently, protecting individuals from accidents and preventing damage to the environment.

We have extensive experience in a wide range of industries and understand their processes and requirements. With intelligent sensors, we can deliver exactly what our customers need. In application centers in Europe, Asia and North America, system solutions are tested and optimized in accordance with customer specifications. All this makes us a reliable supplier and development partner.

Comprehensive services complete our offering: SICK LifeTime Services provide support throughout the machine life cycle and ensure safety and productivity.

For us, that is “Sensor Intelligence.”

WORLDWIDE PRESENCE:

Contacts and other locations –www.sick.com