



CSM-WN111C2P

CSM

COLOR SENSORS

SICK
Sensor Intelligence.



Illustration may differ



Ordering information

Type	part no.
CSM-WN111C2P	1122728

Other models and accessories → www.sick.com/CSM

Detailed technical data

Features

Housing design	Small
Dimensions (W x H x D)	12 mm x 31.5 mm x 21 mm
Light source	LED, RGB ¹⁾
Light emission	Long side of housing
Light spot size	1.9 mm x 9.4 mm
Light spot direction	Vertical
Wave length	640 nm, 525 nm, 470 nm
Sensing distance	≤ 12.5 mm
Sensing distance tolerance	± 3 mm
Adjustment	Teach-in button
Teach-in mode	Teach-in static/dynamic ET: Teach-in dynamic

¹⁾ Average service life: 100,000 h at T_J = +25 °C.

Electronics

Supply voltage	12 V DC ... 24 V DC ¹⁾
Ripple	< 5 V _{pp} ²⁾
Current consumption	< 50 mA ³⁾
Switching frequency	1.7 kHz ⁴⁾

¹⁾ Limit values: DC 12 V (-10 %) ... DC 24 V (+20 %). Operation in short-circuit protected network max. 8 A.

²⁾ May not fall below or exceed U_V tolerances.

³⁾ Without load.

⁴⁾ With light/dark ratio 1:1.

⁵⁾ At supply voltage > 24 V, I_{max} = 50 mA. I_{max} is consumption count of all Q_n.

Response time	300 µs
Jitter	150 µs
Switching output	NPN
Switching output (voltage)	NPN: HIGH = approx. U_V / LOW ≤ 2 V
Switching mode	Light/dark switching
Output (channel)	1 color
Output current I_{max}	< 100 mA ⁵⁾
Input, teach-in (ET)	NPN: Teach: $U < 2$ V, Run: $U = 10$ V ... < U_V or open
Time delay	None
Protection class	III
Circuit protection	U_V connections, reverse polarity protected Output Q short-circuit protected Interference pulse suppression
Connection type	Cable with M12 male connector, 4-pin, 0.2 m

¹⁾ Limit values: DC 12 V (-10 %) ... DC 24 V (+20 %). Operation in short-circuit protected network max. 8 A.

²⁾ May not fall below or exceed U_V tolerances.

³⁾ Without load.

⁴⁾ With light/dark ratio 1:1.

⁵⁾ At supply voltage > 24 V, $I_{max} = 50$ mA. I_{max} is consumption count of all Q_n .

Mechanics

Housing material	ABS
Optics material	PMMA
Weight	Approx. 25 g

Ambient data

Ambient operating temperature	-10 °C ... +55 °C
Ambient temperature, storage	-20 °C ... +75 °C
Shock load	According to IEC 60068
Enclosure rating	IP67
UL File No.	NRKH.E348498 & NRKH7.E348498

Connection type/pinouts

Connection type	Cable with M12 male connector, 4-pin, 0.2 m
Connection type Detail	
Cable material	PVC
Cable diameter	Ø 3.4 mm
Conductor cross section	0.15 mm ²
Pinouts	
BN 1	+ (L+)
WH 2	ET
BU 3	- (M)

BK 4	Q
------	---

Certificates

EU declaration of conformity	✓
UK declaration of conformity	✓
ACMA declaration of conformity	✓
Moroccan declaration of conformity	✓
China RoHS	✓
cULus certificate	✓
Photobiological safety (IEC EN 62471)	✓

Classifications

ECLASS 5.0	27270907
ECLASS 5.1.4	27270907
ECLASS 6.0	27270907
ECLASS 6.2	27270907
ECLASS 7.0	27270907
ECLASS 8.0	27270907
ECLASS 8.1	27270907
ECLASS 9.0	27270907
ECLASS 10.0	27270907
ECLASS 11.0	27270907
ECLASS 12.0	27270907
ETIM 5.0	EC001817
ETIM 6.0	EC001817
ETIM 7.0	EC001817
ETIM 8.0	EC001817
UNSPSC 16.0901	39121528

display and adjustment elements

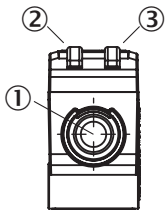

- ① Teach-in button
- ② LED yellow
- ③ LED green

Sensing distance

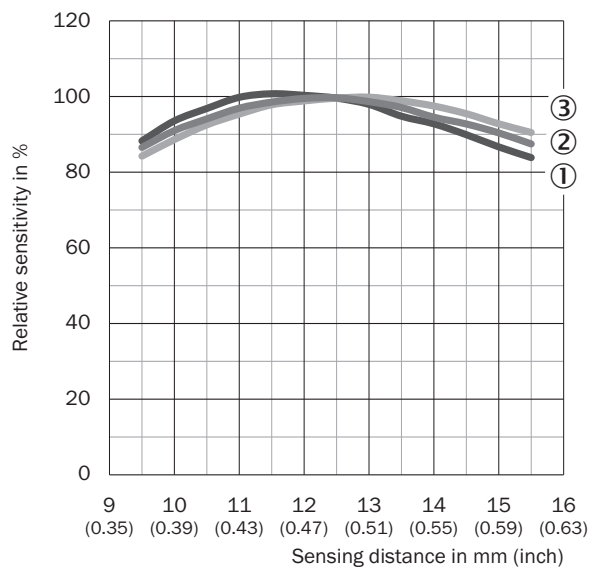



- ① Red
- ② Green
- ③ blue

Recommended accessories

Other models and accessories → www.sick.com/CSM

	Brief description	Type	part no.
Mounting systems			
	<ul style="list-style-type: none"> • Material: Stainless steel • Details: Stainless steel (1.4301) • Suitable for: W4S, W4S 	BEF-WN-G6	2062909

	Brief description	Type	part no.
connectors and cables			
	<ul style="list-style-type: none"> • Description: Unshielded • Connection type head A: Male connector, M12, 4-pin, straight, A-coded • Connection systems: Screw-type terminals • Permitted cross-section: ≤ 0.75 mm² 	STE-1204-G	6009932
	<ul style="list-style-type: none"> • Description: Sensor/actuator cable, unshielded • Connection type head A: Female connector, M12, 4-pin, straight, A-coded • Connection type head B: Flying leads • Signal type: Sensor/actuator cable • Cable: 5 m, 4-wire, PVC • Application: Uncontaminated zones, Zones with chemicals 	YF2A14-050VB3XLEAX	2096235

SICK AT A GLANCE

SICK is one of the leading manufacturers of intelligent sensors and sensor solutions for industrial applications. A unique range of products and services creates the perfect basis for controlling processes securely and efficiently, protecting individuals from accidents and preventing damage to the environment.

We have extensive experience in a wide range of industries and understand their processes and requirements. With intelligent sensors, we can deliver exactly what our customers need. In application centers in Europe, Asia and North America, system solutions are tested and optimized in accordance with customer specifications. All this makes us a reliable supplier and development partner.

Comprehensive services complete our offering: SICK LifeTime Services provide support throughout the machine life cycle and ensure safety and productivity.

For us, that is “Sensor Intelligence.”

WORLDWIDE PRESENCE:

Contacts and other locations –www.sick.com