



DATA SHEET

WLD4FP-313111A0ZZZ

W4
Photoelectric sensors

PHOTOELECTRIC SENSORS

WLD4F-
P-313111A0ZZZ

ORDERING INFORMATION

Type	part no.
WLD4FP-313111A0ZZZ	1121475

Further device versions and accessories at www.sick.com/W4



Illustration may differ

DETAILED TECHNICAL DATA

FEATURES

Functional principle	Photoelectric retro-reflective sensor	
Functional principle detail	With minimum distance to reflector (dual lens system)	
Sensing range	Sensing range min.	0 m
	Sensing range max.	4.5 m
	Maximum distance range from reflector to sensor (operating reserve 1)	0.015 m ... 4.5 m
	Recommended distance range from reflector to sensor (operating reserve 3,75)	0.035 m ... 3.9 m
	Reference reflector	Reflector P250
	Recommended sensing range for the best performance	0.035 m ... 3.9 m
Polarisation filter	Yes	
Emitted beam	Light source	PinPoint LED
	Type of light	Visible red light
	Shape of light spot	Point-shaped
	Light spot size (distance)	Ø 38 mm (1,000 mm)
	Maximum dispersion of the emitted beam around the standardized transmission axis (squint angle)	< +/- 1.5° (at T ₀ = +23 °C)
Key LED figures	Normative reference	EN 62471:2008-09 IEC 62471:2006, modified
	LED risk group marking	Free group
	Wave length	635 nm
	Average service life	100,000 h at T _a = +25 °C
Adjustment		

	None	-
Display	LED green	Operating indicator Static on: power on
	LED yellow	Status of received light beam Static on: object not present Static off: object present Flashing: Below the 1.5 function reserve

SAFETY-RELATED PARAMETERS

MTTF _D	1,390 years
DC _{avg}	0 %
T _M (mission time)	20 years

ELECTRONICS

Supply voltage U _B	10 V DC ... 30 V DC ¹⁾																				
Ripple	≤ 5 V _{pp}																				
Usage category	DC-12 (According to EN 60947-5-2) DC-13 (According to EN 60947-5-2)																				
Current consumption	≤ 20 mA, without load. At U _B = 24 V																				
Protection class	III																				
Digital output	<table border="0"> <tr> <td>Number</td> <td>1</td> </tr> <tr> <td>Type</td> <td>Push-pull: PNP/NPN</td> </tr> <tr> <td>Switching mode</td> <td>Dark switching</td> </tr> <tr> <td>Signal voltage PNP HIGH/LOW</td> <td>Approx. U_B - 2.5 V / 0 V</td> </tr> <tr> <td>Signal voltage NPN HIGH/LOW</td> <td>Approx. U_B / < 2.5 V</td> </tr> <tr> <td>Output current I_{max}</td> <td>≤ 100 mA</td> </tr> <tr> <td>Circuit protection outputs</td> <td>Reverse polarity protected Overcurrent protected Short-circuit protected</td> </tr> <tr> <td>Response time</td> <td>≤ 500 μs</td> </tr> <tr> <td>Repeatability (response time)</td> <td>150 μs²⁾</td> </tr> <tr> <td>Switching frequency</td> <td>1,000 Hz³⁾</td> </tr> </table>	Number	1	Type	Push-pull: PNP/NPN	Switching mode	Dark switching	Signal voltage PNP HIGH/LOW	Approx. U _B - 2.5 V / 0 V	Signal voltage NPN HIGH/LOW	Approx. U _B / < 2.5 V	Output current I _{max}	≤ 100 mA	Circuit protection outputs	Reverse polarity protected Overcurrent protected Short-circuit protected	Response time	≤ 500 μs	Repeatability (response time)	150 μs ²⁾	Switching frequency	1,000 Hz ³⁾
Number	1																				
Type	Push-pull: PNP/NPN																				
Switching mode	Dark switching																				
Signal voltage PNP HIGH/LOW	Approx. U _B - 2.5 V / 0 V																				
Signal voltage NPN HIGH/LOW	Approx. U _B / < 2.5 V																				
Output current I _{max}	≤ 100 mA																				
Circuit protection outputs	Reverse polarity protected Overcurrent protected Short-circuit protected																				
Response time	≤ 500 μs																				
Repeatability (response time)	150 μs ²⁾																				
Switching frequency	1,000 Hz ³⁾																				
Pin/Wire assignment	<table border="0"> <tr> <td>Function of pin 4/black (BK)</td> <td>Digital output, dark switching, object present → output Q HIGH⁴⁾</td> </tr> </table>	Function of pin 4/black (BK)	Digital output, dark switching, object present → output Q HIGH ⁴⁾																		
Function of pin 4/black (BK)	Digital output, dark switching, object present → output Q HIGH ⁴⁾																				

¹⁾ Limit values.

²⁾ Signal transit time with resistive load in switching mode.

³⁾ With light/dark ratio 1:1.

⁴⁾ This switching output must not be connected to another output.

MECHANICS

Housing	Rectangular						
Design detail	Flat						
Dimensions (W x H x D)	16 mm x 40.1 mm x 12.1 mm						
Connection	Cable with connector M8, 3-pin, 110 mm						
Connection detail	<table border="0"> <tr> <td>Deep-freeze property</td> <td>Do not bend below 0 °C</td> </tr> <tr> <td>Conductor size</td> <td>0.14 mm²</td> </tr> <tr> <td>Cable diameter</td> <td>Ø 3.4 mm</td> </tr> </table>	Deep-freeze property	Do not bend below 0 °C	Conductor size	0.14 mm ²	Cable diameter	Ø 3.4 mm
Deep-freeze property	Do not bend below 0 °C						
Conductor size	0.14 mm ²						
Cable diameter	Ø 3.4 mm						

	Length of cable (L)	77 mm
Material	Housing	Plastic, VISTAL®
	Front screen	Plastic, PMMA
	Cable	Plastic, PVC
	Male connector	Plastic, VISTAL®
Weight		Approx. 30 g
Maximum tightening torque of the fixing screws		0.4 Nm

AMBIENT DATA

Enclosure rating	IP66 (EN 60529) IP67 (EN 60529) IP69 (EN 60529)
Ambient operating temperature	-40 °C ... +60 °C
Ambient temperature, storage	-40 °C ... +75 °C
Typ. Ambient light immunity	Artificial light: ≤ 50,000 lx Sunlight: ≤ 50,000 lx
Shock resistance	30 g, 11 ms (3 positive and 3 negative shocks along X, Y, Z axes, 18 total shocks (EN60068-2-27))
Vibration resistance	10 Hz ... 1,000 Hz (Amplitude 1 mm, 3 x 30 min (EN60068-2-6))
Air humidity	35 % ... 95 %, relative humidity (no condensation)
Electromagnetic compatibility (EMC)	EN 60947-5-2
Resistance to cleaning agent	ECOLAB
UL File No.	NRKH.E181493 & NRKH7.E181493

CERTIFICATES

EU declaration of conformity	✓
UK declaration of conformity	✓
ACMA declaration of conformity	✓
Moroccan declaration of conformity	✓
China RoHS	✓
ECOLAB certificate	✓
cULus certificate	✓

DISPLAY AND ADJUSTMENT ELEMENTS

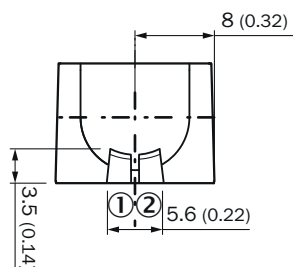

- ① LED green
- ② LED yellow

CONNECTION TYPE CONNECTOR M8, 3-PIN

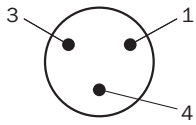

CONNECTION DIAGRAM CD-514

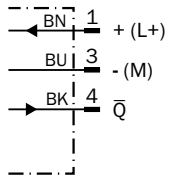

TRUTH TABLE PUSH-PULL: PNP/NPN - DARK SWITCHING \bar{Q}

	Dark switching \bar{Q} (normally open (upper switch), normally closed (lower switch))	
	Object not present → Output LOW	Object present → Output HIGH
Light receive	✓	✗
Light receive indicator	☀	✗
Load resistance to L+	⚡	✗
Load resistance to M	✗	⚡
	<p>The diagram shows the sensor emitting light towards a transparent surface. The output \bar{Q} is shown as a normally open switch that is currently open, resulting in a LOW output.</p>	<p>The diagram shows the sensor emitting light towards a solid block. The output \bar{Q} is shown as a normally open switch that is currently closed, resulting in a HIGH output.</p>

TRUTH TABLE PUSH-PULL: PNP/NPN - LIGHT SWITCHING Q

	Light switching Q (normally closed (upper switch), normally open (lower switch))	
	Object not present → Output HIGH	Object present → Output LOW
Light receive	✓	✗
Light receive indicator	☀	✗
Load resistance to L+	✗	⚡
Load resistance to M	⚡	✗

CHARACTERISTIC CURVE STANDARD REFLECTORS

Operating reserve

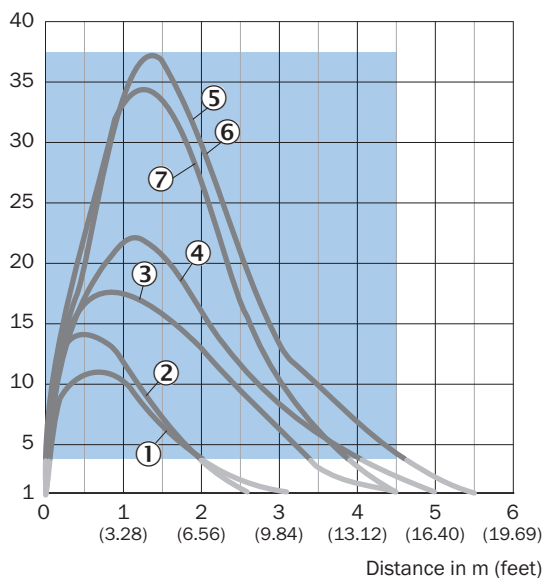

Recommended sensing range for the best performance

- ① Reflector PL22
- ② Reflector PL20A
- ③ Reflector PL30A
- ④ Reflector PL40A
- ⑤ Reflector PL80A
- ⑥ Reflector C110A
- ⑦ Reflector P250

CHARACTERISTIC CURVE REFLECTIVE TAPE

Operating reserve

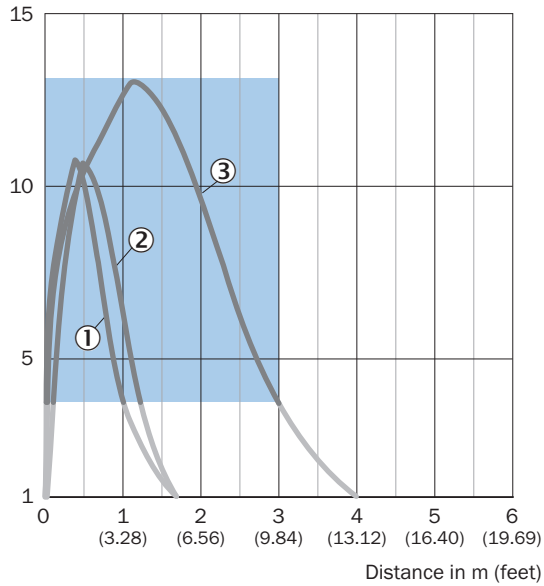

- Recommended sensing range for the best performance
- ① Reflective tape REF-DG
- ② reflective tape REF-IRF-56
- ③ Reflective tape REF-AC1000

CHARACTERISTIC CURVE FINE TRIPLE REFLECTORS

Operating reserve

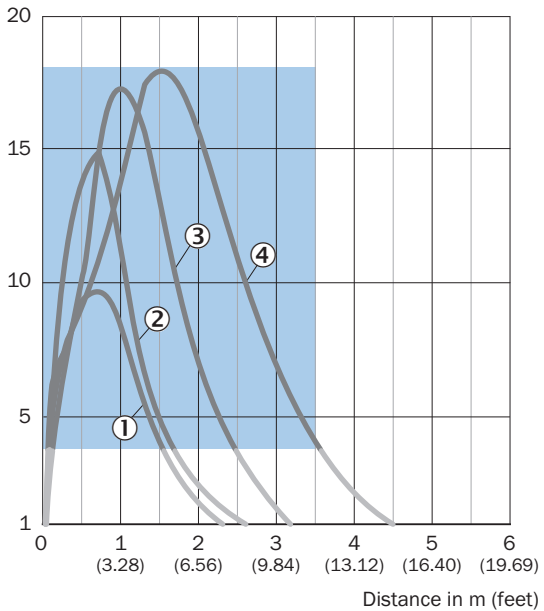

- Recommended sensing range for the best performance
- ① PL10FH reflector
- ② PL10F reflector
- ③ Reflector PL20F
- ④ Reflector P250F

CHARACTERISTIC CURVE CHEMICAL-RESISTANT REFLECTORS

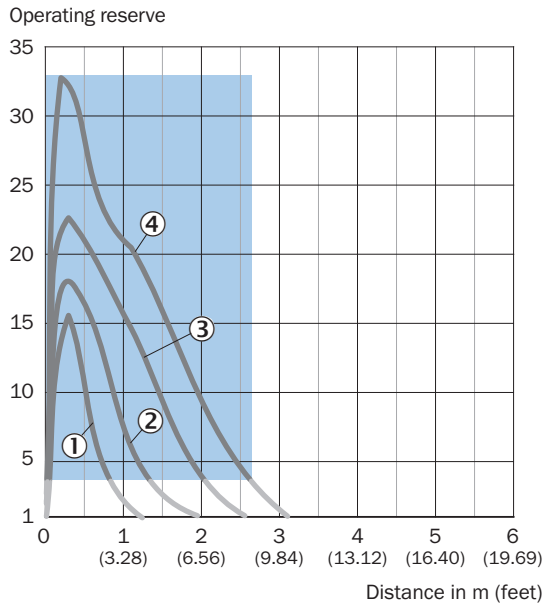

Recommended sensing range for the best performance

- ① PL10F CHEM reflector
- ② Reflector PL20 CHEM
- ③ Reflector P250 CHEM
- ④ Reflector P250H

LIGHT SPOT SIZE

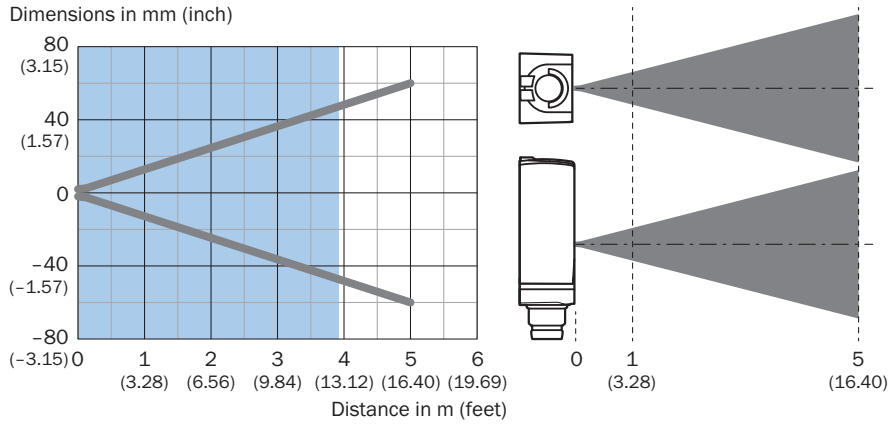

Recommended sensing range for the best performance

SENSING RANGE DIAGRAM STANDARD REFLECTORS

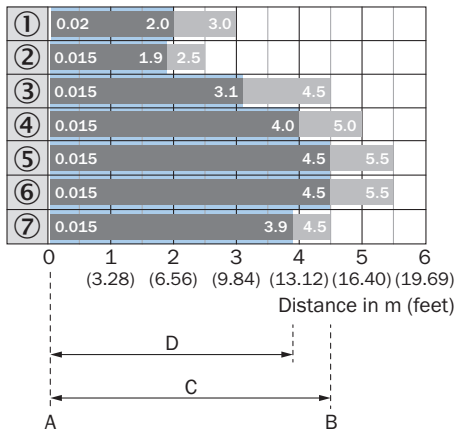

A = Sensing range min. in m
 B = Sensing range max. in m
 C = Maximum distance range from reflector to sensor (operating reserve 1)
 D = Recommended distance range from reflector to sensor (operating reserve 3.75)

Recommended sensing range for the best performance

- ① Reflector PL22
- ② Reflector PL20A
- ③ Reflector PL30A
- ④ Reflector PL40A
- ⑤ Reflector PL80A
- ⑥ Reflector C110A
- ⑦ Reflector P250

SENSING RANGE DIAGRAM REFLECTIVE TAPE

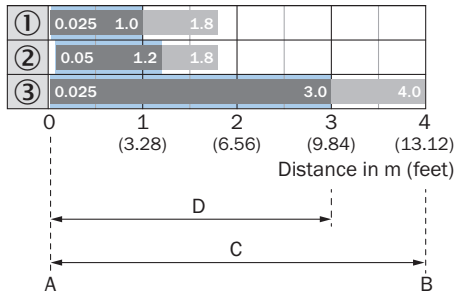

A = Sensing range min. in m
 B = Sensing range max. in m
 C = Maximum distance range from reflector to sensor (operating reserve 1)
 D = Recommended distance range from reflector to sensor (operating reserve 3.75)

Recommended sensing range for the best performance

- ① Reflective tape REF-DG (50 x 50 mm)
- ② reflective tape REF-IRF-56
- ③ Reflective tape REF-AC1000

SENSING RANGE DIAGRAM FINE TRIPLE REFLECTORS

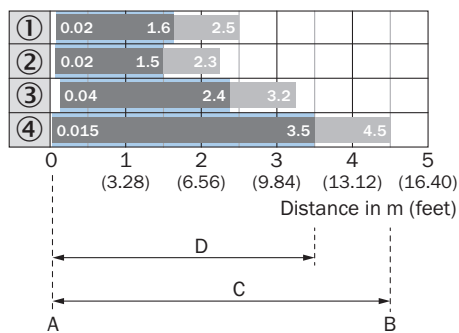

A = Sensing range min. in m
 B = Sensing range max. in m
 C = Maximum distance range from reflector to sensor (operating reserve 1)
 D = Recommended distance range from reflector to sensor (operating reserve 3.75)

Recommended sensing range for the best performance

- ① PL10FH reflector
- ② PL10F reflector
- ③ Reflector PL20F
- ④ Reflector P250F

SENSING RANGE DIAGRAM CHEMICAL-RESISTANT REFLECTORS

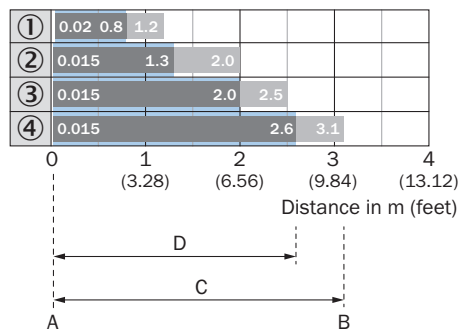

A = Sensing range min. in m
 B = Sensing range max. in m
 C = Maximum distance range from reflector to sensor (operating reserve 1)
 D = Recommended distance range from reflector to sensor (operating reserve 3.75)

Recommended sensing range for the best performance

- ① PL10F CHEM reflector
- ② Reflector PL20 CHEM
- ③ Reflector P250 CHEM
- ④ Reflector P250H

DIMENSIONAL DRAWING

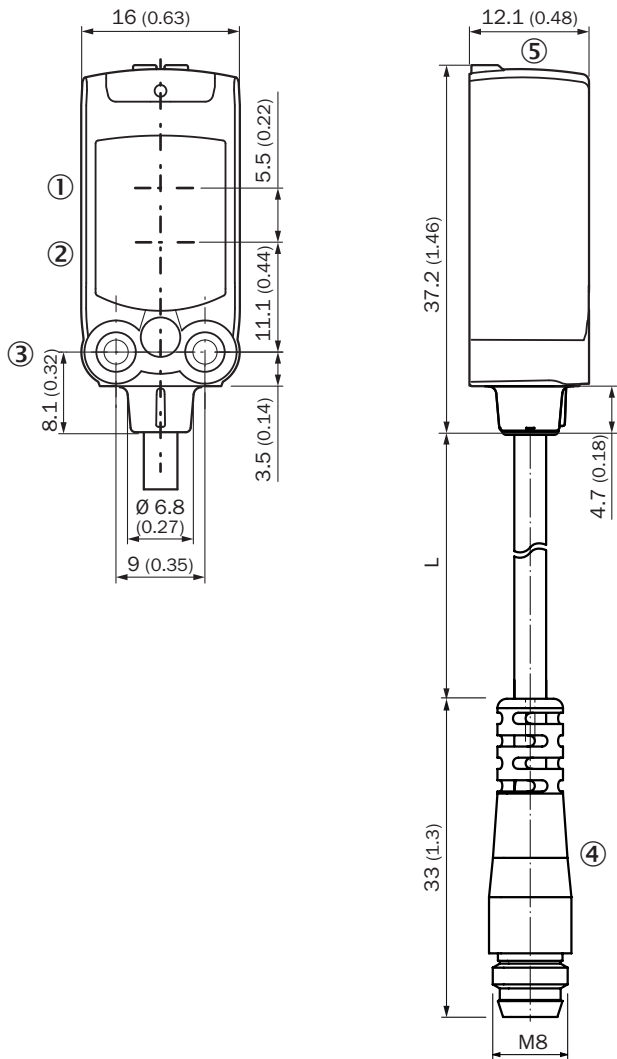

Dimensions in mm (inch)

For length of cable (L), see technical data

- ① Center of optical axis, sender
- ② Center of optical axis, receiver
- ③ M3 mounting hole
- ④ cable with connector M8
- ⑤ display and adjustment elements

Further information as well as suitable accessories, example applications and downloads such as CAD dimensional models, operating instructions and software can be found at www.sick.com/1121475



SICK AG
WALDKIRCH
GERMANY
SICK.COM

SICK AT A GLANCE

SICK is a leading global technology company for intelligent sensors and integrated solutions in industrial automation. Our technologies set benchmarks, making your industrial processes more efficient, safer and more sustainable – both in logistics and manufacturing operations.

SICK combines sensor intelligence with industry expertise and certified consulting services. We provide the ideal foundation for scalable as well as tailor-made automation solutions and create added value along the entire value chain. Our close partnerships with our customers are more than just a promise: Together, we optimize productivity, improve quality, protect health and safety, and help build a sustainable future. All with empathy and trust.

Since 1946, we have been developing innovative technologies with passion and a pioneering spirit. With a global network in around 40 countries, SICK has a global presence and is always close by. The company's headquarters are located in Waldkirch near Freiburg, Germany. Our customers benefit from our understanding of both local and global requirements, which enables us to deliver tailor-made solutions

SICK
Sensor Intelligence