



# AS30-EBM314I220C00

AS30

ARRAY SENSORS

**SICK**  
Sensor Intelligence.



Illustration may differ



### Ordering information

Type	part no.
AS30-EBM314I220C00	1121191

**Included in delivery:** REF-AX-002 (1)

Other models and accessories → [www.sick.com/AS30](http://www.sick.com/AS30)

### Detailed technical data

#### Features

<b>Sensor principle</b>	Proximity system, Reflector mode
<b>Functional principle</b>	Web guiding, positioning
<b>Principle of operation (default)</b>	Web guiding
<b>Housing design</b>	Middle
<b>Dimensions (W x H x D)</b>	31 mm x 62 mm x 52.2 mm
<b>Light source</b>	LED, White
<b>Light spot size</b>	38.9 mm x 11.1 mm
<b>Wave length</b>	400 nm ... 700 nm
<b>Working range</b>	20 mm ... 30 mm
<b>Measurement range</b>	20 mm
<b>Sensing distance</b>	≤ 25 mm
<b>Minimum detectable object (MDO)</b>	0.2 mm
<b>Linearity (position value)</b>	± 2 %
<b>Resolution</b>	1 μm
<b>Repeatability</b>	0.03 mm <sup>1)</sup>
<b>Adjustment</b>	IO-Link, Display
<b>Teach-in mode</b>	Edge detection Area detection

<sup>1)</sup> With respect to sensing distance.

<b>Output time</b>	1 ms
<b>Safety-related parameters</b>	
MTTF <sub>D</sub>	271 years

<sup>1)</sup> With respect to sensing distance.

## Interfaces

<b>IO-Link</b>	✓
VendorID	26
DeviceID HEX	0x80020B
DeviceID DEC	8389131
<b>Cycle time</b>	> 1.1 ms

## Electronics

<b>Supply voltage</b>	18 V ... 30 V
<b>Ripple</b>	≤ 5 V <sup>1)</sup>
<b>Current consumption</b>	< 3.1 W <sup>2)</sup>
<b>Initialization time</b>	0.48 s
<b>Switching frequency</b>	500 Hz
<b>Switching output</b>	Push-pull: PNP/NPN
<b>Switching output (voltage)</b>	Push-pull: PNP/NPN HIGH = U <sub>V</sub> - 3 V/LOW ≤ 3 V
<b>Analog output</b>	4 mA ... 20 mA
<b>Resolution of analog output</b>	12 bit
<b>Output rate of analog output</b>	1 ms
<b>Output current I<sub>max</sub></b>	< 100 mA
<b>Protection class</b>	III <sup>3)</sup>
<b>Circuit protection</b>	U <sub>V</sub> connections, reverse polarity protected Output Q short-circuit protected Interference pulse suppression
<b>Connection type</b>	Plug, M12, 5-pin

<sup>1)</sup> May not fall below or exceed U<sub>V</sub> tolerances.

<sup>2)</sup> Without load.

<sup>3)</sup> I<sub>N</sub> = 2 A.

## Mechanics

<b>Housing material</b>	Zinc diecast
<b>Optics material</b>	Anti-reflex coating
<b>Weight</b>	250 g

## Ambient data

<b>Ambient operating temperature</b>	-10 °C ... +55 °C
<b>Ambient temperature, storage</b>	-25 °C ... +75 °C
<b>Shock load</b>	According to IEC 60068
<b>Enclosure rating</b>	IP67
<b>UL File No.</b>	NRKH.E181493 & NRKH7.E181493

### Smart Task

<b>Smart Task name</b>	Base logics
<b>Logic function</b>	Direct AND OR Window
<b>Switching signal</b>	
Switching signal Q <sub>L1</sub>	Switching output
Switching signal Q <sub>L2</sub>	Switching output

### Certificates

<b>EU declaration of conformity</b>	✓
<b>UK declaration of conformity</b>	✓
<b>ACMA declaration of conformity</b>	✓
<b>Moroccan declaration of conformity</b>	✓
<b>China RoHS</b>	✓
<b>cULus certificate</b>	✓
<b>IO-Link certificate</b>	✓
<b>Photobiological safety (IEC EN 62471)</b>	✓
<b>Information according to Art. 3 of Data Act (Regulation EU 2023/2854)</b>	✓

### Classifications

<b>ECLASS 5.0</b>	27270906
<b>ECLASS 5.1.4</b>	27270906
<b>ECLASS 6.0</b>	27270906
<b>ECLASS 6.2</b>	27270906
<b>ECLASS 7.0</b>	27270906
<b>ECLASS 8.0</b>	27270906
<b>ECLASS 8.1</b>	27270906
<b>ECLASS 9.0</b>	27270906
<b>ECLASS 10.0</b>	27270906
<b>ECLASS 11.0</b>	27270906
<b>ECLASS 12.0</b>	27270906
<b>ETIM 5.0</b>	EC001820
<b>ETIM 6.0</b>	EC001820
<b>ETIM 7.0</b>	EC001820
<b>ETIM 8.0</b>	EC001820
<b>UNSPSC 16.0901</b>	39121528

Dimensional drawing AS30-xxx31xxxxxxx

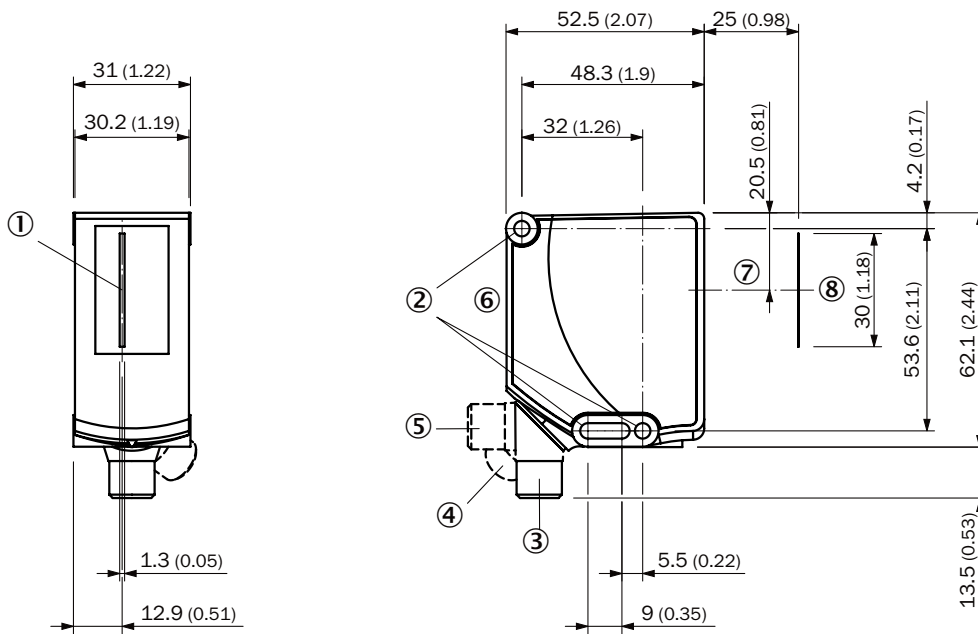

Dimensions in mm (inch)

- ① Center field of view
- ② fixing hole
- ③ M12 male connector, delivery state
- ④ M12 male connector, end stop right
- ⑤ M12 male connector, end stop left
- ⑥ display and adjustment elements
- ⑦ Optical axis
- ⑧ Field of view

display and adjustment elements

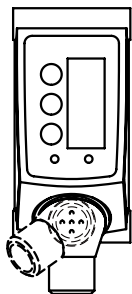



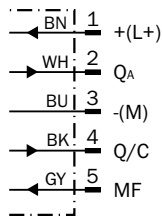







### Connection diagram Cd-435



### Recommended accessories

Other models and accessories → [www.sick.com/AS30](http://www.sick.com/AS30)

	Brief description	Type	part no.
<b>Mounting systems</b>			
	<ul style="list-style-type: none"> <li><b>Description:</b> Holder for reflector foil (scope of delivery AS30) or accessory reflector. Simply align and set the correct scanning distance.</li> <li><b>Material:</b> Steel</li> <li><b>Details:</b> Steel, zinc coated</li> <li><b>Items supplied:</b> Reflector holder, screw set for AS30 and reflector PL25FA (5340878)</li> <li><b>Suitable for:</b> AS30</li> </ul>	REFLECTORHOLD-ER SD25	2107380
	<ul style="list-style-type: none"> <li><b>Description:</b> Bracket for easy mounting of ELA external illumination as a backlight. Suitable for all AS30 Prime with 25 mm sensing distance.</li> <li><b>Material:</b> Steel</li> <li><b>Details:</b> Steel, zinc coated</li> <li><b>Items supplied:</b> Mounting bracket, Screw set for AS30 and ELA</li> <li><b>Suitable for:</b> AS30, ELA, AS30</li> </ul>	SET FORK HOLD-ER ELA SD25	2134662
	<ul style="list-style-type: none"> <li><b>Description:</b> Plate K for universal clamp bracket</li> <li><b>Material:</b> Steel</li> <li><b>Details:</b> Steel, zinc coated</li> <li><b>Items supplied:</b> Universal clamp (2022726), mounting hardware</li> <li><b>Usable for:</b> W11-2, W12-3, W14-2, W18-3, W23-2, W24-2, W27-3, W30, W32, W34, W36, PL50A, PL80A, P250, UC12, LUT3, KT2, KT5-2, KT8, CS8, DT2, DS30, DS40, W12-2 Laser, W16, W26, KT5</li> </ul>	BEF-KHS-K01	2022718
	<ul style="list-style-type: none"> <li><b>Material:</b> Aluminum</li> <li><b>Details:</b> Aluminum</li> <li><b>Items supplied:</b> Mounting hardware for the sensor included</li> <li><b>Usable for:</b> Adapter plate for AX20 to AS30</li> </ul>	BEF-AP-AS30	2124602
<b>connectors and cables</b>			
	<ul style="list-style-type: none"> <li><b>Description:</b> Unshielded</li> <li><b>Connection type head A:</b> Male connector, M12, 5-pin, straight, A-coded</li> <li><b>Connection systems:</b> Screw-type terminals</li> <li><b>Permitted cross-section:</b> ≤ 0.75 mm<sup>2</sup></li> <li><b>Note:</b> For field bus technology</li> </ul>	STE-1205-G	6022083
	<ul style="list-style-type: none"> <li><b>Description:</b> Sensor/actuator cable, unshielded</li> <li><b>Connection type head A:</b> Female connector, M12, 5-pin, straight, A-coded</li> <li><b>Connection type head B:</b> Flying leads</li> <li><b>Signal type:</b> Sensor/actuator cable</li> <li><b>Cable:</b> 5 m, 5-wire, PVC</li> <li><b>Application:</b> Uncontaminated zones, Zones with chemicals</li> </ul>	YF2A15-050VB5XLEAX	2096240

	Brief description	Type	part no.
network devices			
		SIG200-0A04I2200	1089794
		SIG200-0A0GI2200	1102605
reflectors and optics			
	<ul style="list-style-type: none"> <li>• <b>Description:</b> Fine triple, planar, suitable for laser sensors</li> <li>• <b>Dimensions:</b> 75 mm 25 mm</li> <li>• <b>Ambient operating temperature:</b> -30 °C ... +65 °C</li> </ul>	PL25FA	5340878
integration modules and adapters			
		IOLA2US-01101 (SiLink2 Master)	1061790

## SICK AT A GLANCE

SICK is one of the leading manufacturers of intelligent sensors and sensor solutions for industrial applications. A unique range of products and services creates the perfect basis for controlling processes securely and efficiently, protecting individuals from accidents and preventing damage to the environment.

We have extensive experience in a wide range of industries and understand their processes and requirements. With intelligent sensors, we can deliver exactly what our customers need. In application centers in Europe, Asia and North America, system solutions are tested and optimized in accordance with customer specifications. All this makes us a reliable supplier and development partner.

Comprehensive services complete our offering: SICK LifeTime Services provide support throughout the machine life cycle and ensure safety and productivity.

For us, that is “Sensor Intelligence.”

## WORLDWIDE PRESENCE:

Contacts and other locations –[www.sick.com](http://www.sick.com)