



# CSS-WBFA54115AA10Z

CSS/CSX High Speed

COLOR SENSORS

**SICK**  
Sensor Intelligence.



Illustration may differ

### Ordering information

Type	part no.
CSS-WBFA54115AA10Z	1120170

Other models and accessories → [www.sick.com/CSS\\_CSX\\_High\\_Speed](http://www.sick.com/CSS_CSX_High_Speed)



### Detailed technical data

#### Features

<b>Parameter presettings</b>	None
<b>Housing design</b>	Small
<b>Dimensions (W x H x D)</b>	26 mm x 62 mm x 47.5 mm
<b>Light source</b>	LED, RGB <sup>1)</sup>
<b>Light emission</b>	Long side of housing
<b>Light spot size</b>	Ø 12 mm
<b>Light spot direction</b>	Round, large
<b>Wave length</b>	460 nm, 530 nm, 625 nm
<b>LED risk group marking</b>	1
<b>Color mode</b>	C (Color) C + I (Color + Illumination)
<b>Sensing distance</b>	60 mm
<b>Sensing distance tolerance</b>	± 9 mm
<b>Teach-in mode</b>	Single value teach-in Multi value teach-in
<b>Output mode</b>	2 colors in standard mode/best fit mode 3 colors in coded mode
<b>Output (channel)</b>	2 × hardware switching outputs 24 x virtual switching outputs via IO-Link
<b>Adjustment of the sensitivity</b>	Continuous: 0 ... 999

<sup>1)</sup> Average service life: 100,000 h at T<sub>U</sub> = +25 °C.

<b>Available job banks</b>	4
<b>Safety-related parameters</b>	
MTTF <sub>D</sub>	263.7 years

<sup>1)</sup> Average service life: 100,000 h at T<sub>U</sub> = +25 °C.

### Interfaces

<b>IO-Link</b>	✓, IO-Link V1.1.2
VendorID	26
DeviceID HEX	80028E
DeviceID DEC	8389262
<b>Digital output</b>	Q <sub>1</sub> , Q <sub>2</sub>
Number	2
<b>Digital input</b>	In <sub>1</sub> , In <sub>2</sub>
Number	2

### Electronics

<b>Supply voltage</b>	10.8 V DC ... 28.8 V DC <sup>1)</sup>
<b>Ripple</b>	≤ 5 V <sub>pp</sub> <sup>2)</sup>
<b>Current consumption</b>	< 120 mA <sup>3)</sup>
<b>Switching frequency</b>	13.8 kHz
<b>Response time</b>	36 μs
<b>Jitter</b>	18 μs
<b>Switching output</b>	Push-pull: PNP/NPN
<b>Switching output (voltage)</b>	Push-pull: PNP/NPN HIGH = U <sub>V</sub> - 3 V/LOW ≤ 3 V
<b>Output current I<sub>max</sub></b>	100 mA <sup>4)</sup>
<b>Input, teach-in (ET)</b>	Teach: U = 10 V ... < V <sub>S</sub>
<b>Input, blanking input (AT)</b>	Blanked: U = 10 V ... < U <sub>v</sub>
<b>Retention time (ET)</b>	3 s, non-volatile memory
<b>Time delay</b>	None
<b>Protection class</b>	III
<b>Circuit protection</b>	U <sub>V</sub> connections, reverse polarity protected Output Q short-circuit protected Interference pulse suppression
<b>Connection type</b>	Plug, M12, 5-pin

<sup>1)</sup> Limit values: DC 12 V (-10 %) ... DC 24 V (+20 %). Operation in short-circuit protected network max. 8 A.

<sup>2)</sup> May not fall below or exceed U<sub>V</sub> tolerances.

<sup>3)</sup> Without load.

<sup>4)</sup> Total current of all Outputs.

### Mechanics

<b>Housing material</b>	VISTAL®
<b>Optics material</b>	Glass

<b>Weight</b>	68 g
---------------	------

### Ambient data

<b>Ambient operating temperature</b>	-20 °C ... +60 °C
<b>Ambient temperature, storage</b>	-25 °C ... +75 °C
<b>Shock load</b>	According to IEC 60068-2-27 (30 g/11 ms)
<b>Enclosure rating</b>	IP67
<b>UL File No.</b>	E181493

### Connection type/pinouts

<b>Connection type</b>	Plug, M12, 5-pin	
<b>Pinouts</b>	BN 1	+ (L+)
	WH 2	Q <sub>L2</sub> /IN <sub>1</sub>
	BU 3	- (M)
	BK 4	Q <sub>L1</sub> /C
	GY 5	In <sub>2</sub>

### Certificates

<b>EU declaration of conformity</b>	✓
<b>UK declaration of conformity</b>	✓
<b>ACMA declaration of conformity</b>	✓
<b>Moroccan declaration of conformity</b>	✓
<b>China RoHS</b>	✓
<b>cULus certificate</b>	✓
<b>IO-Link certificate</b>	✓
<b>Photobiological safety (IEC EN 62471)</b>	✓
<b>Information according to Art. 3 of Data Act (Regulation EU 2023/2854)</b>	✓

### Classifications

<b>ECLASS 5.0</b>	27270907
<b>ECLASS 5.1.4</b>	27270907
<b>ECLASS 6.0</b>	27270907
<b>ECLASS 6.2</b>	27270907
<b>ECLASS 7.0</b>	27270907
<b>ECLASS 8.0</b>	27270907
<b>ECLASS 8.1</b>	27270907
<b>ECLASS 9.0</b>	27270907
<b>ECLASS 10.0</b>	27270907
<b>ECLASS 11.0</b>	27270907
<b>ECLASS 12.0</b>	27270907
<b>ETIM 5.0</b>	EC001817

<b>ETIM 6.0</b>	EC001817
<b>ETIM 7.0</b>	EC001817
<b>ETIM 8.0</b>	EC001817
<b>UNSPSC 16.0901</b>	39121528

Dimensional drawing, sensor

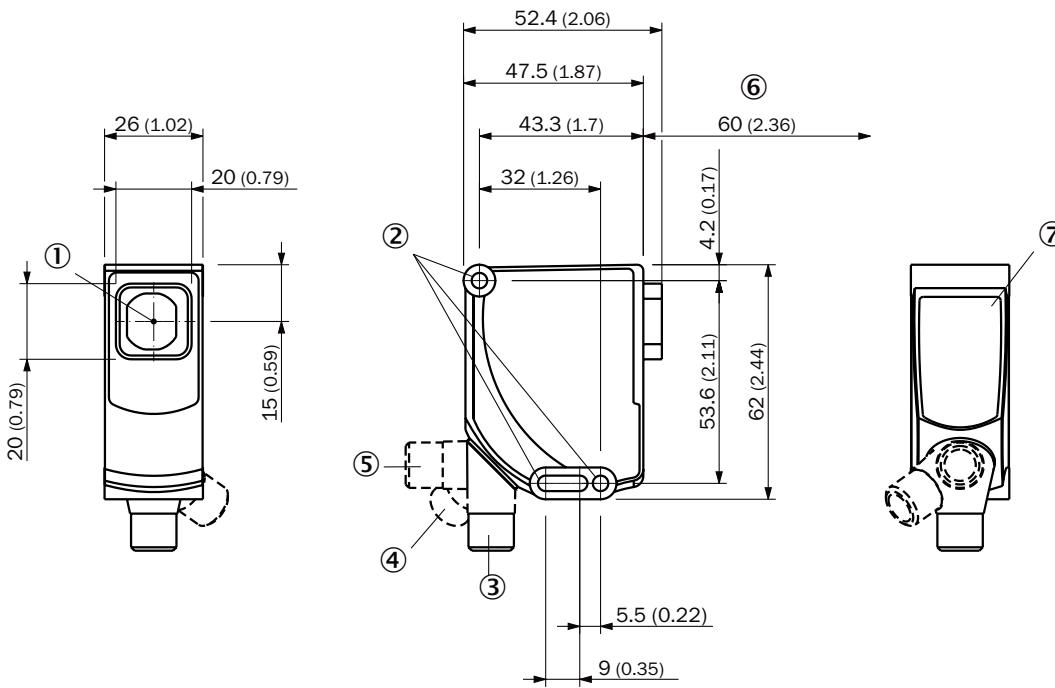

Dimensions in mm (inch)

- ① Optical axis
- ② fixing hole
- ③ M12 male connector, delivery state
- ④ M12 male connector, end stop right
- ⑤ M12 male connector, end stop left
- ⑥ Sensing distance
- ⑦ display and adjustment elements

Pinouts, see table [Technical data: Connection type/pinouts](#)

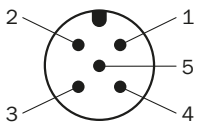

Male connector, M12, 5-pin, A-coded

### display and adjustment elements

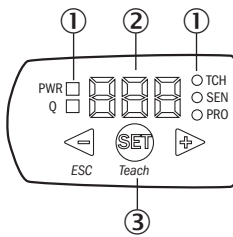







- ① LEDs (status display)
- ② 7-segment display
- ③ Plus/minus button

### Recommended accessories

Other models and accessories → [www.sick.com/CSS\\_CSX\\_High\\_Speed](http://www.sick.com/CSS_CSX_High_Speed)

	Brief description	Type	part no.
Mounting systems			
	<ul style="list-style-type: none"> <li>• <b>Description:</b> Plate K for universal clamp bracket</li> <li>• <b>Material:</b> Steel</li> <li>• <b>Details:</b> Steel, zinc coated</li> <li>• <b>Items supplied:</b> Universal clamp (2022726), mounting hardware</li> <li>• <b>Usable for:</b> W11-2, W12-3, W14-2, W18-3, W23-2, W24-2, W27-3, W30, W32, W34, W36, PL50A, PL80A, P250, UC12, LUT3, KT2, KT5-2, KT8, CS8, DT2, DS30, DS40, W12-2 Laser, W16, W26, KT5</li> </ul>	BEF-KHS-K01	2022718

	Brief description	Type	part no.
network devices			
		IOLA2US-01101 (SiLink2 Master)	1061790
		SIG350-0004AP100	6076871
		SIG350-0005AP100	6076923
		SIG350-0006AP100	6076924
connectors and cables			
	<ul style="list-style-type: none"> <li>• <b>Description:</b> Unshielded</li> <li>• <b>Connection type head A:</b> Male connector, M12, 5-pin, straight, A-coded</li> <li>• <b>Connection systems:</b> Screw-type terminals</li> <li>• <b>Permitted cross-section:</b> ≤ 0.75 mm<sup>2</sup></li> <li>• <b>Note:</b> For field bus technology</li> </ul>	STE-1205-G	6022083
	<ul style="list-style-type: none"> <li>• <b>Description:</b> Sensor/actuator cable, unshielded</li> <li>• <b>Connection type head A:</b> Female connector, M12, 5-pin, straight, A-coded</li> <li>• <b>Connection type head B:</b> Flying leads</li> <li>• <b>Signal type:</b> Sensor/actuator cable</li> <li>• <b>Cable:</b> 5 m, 5-wire, PVC</li> <li>• <b>Application:</b> Uncontaminated zones, Zones with chemicals</li> </ul>	YF2A15-050VB5XLEAX	2096240

## SICK AT A GLANCE

SICK is one of the leading manufacturers of intelligent sensors and sensor solutions for industrial applications. A unique range of products and services creates the perfect basis for controlling processes securely and efficiently, protecting individuals from accidents and preventing damage to the environment.

We have extensive experience in a wide range of industries and understand their processes and requirements. With intelligent sensors, we can deliver exactly what our customers need. In application centers in Europe, Asia and North America, system solutions are tested and optimized in accordance with customer specifications. All this makes us a reliable supplier and development partner.

Comprehensive services complete our offering: SICK LifeTime Services provide support throughout the machine life cycle and ensure safety and productivity.

For us, that is “Sensor Intelligence.”

## WORLDWIDE PRESENCE:

Contacts and other locations –[www.sick.com](http://www.sick.com)