



CSS-WBF114115AA10Z

CSS/CSX High Speed

COLOR SENSORS

SICK
Sensor Intelligence.



Illustration may differ



Ordering information

Type	part no.
CSS-WBF114115AA10Z	1120168

Other models and accessories → www.sick.com/CSS_CSX_High_Speed

Detailed technical data

Features

Parameter presettings	None
Housing design	Small
Dimensions (W x H x D)	26 mm x 62 mm x 47.5 mm
Light source	LED, RGB ¹⁾
Light emission	Long side of housing
Light spot size	2 mm x 4 mm
Light spot direction	Vertical ²⁾
Wave length	460 nm, 530 nm, 625 nm
LED risk group marking	1
Color mode	C (Color) C + I (Color + Illumination)
Sensing distance	13 mm
Sensing distance tolerance	± 5 mm
Teach-in mode	Single value teach-in Multi value teach-in
Output mode	2 colors in standard mode/best fit mode 3 colors in coded mode
Output (channel)	2 × hardware switching outputs 24 x virtual switching outputs via IO-Link

¹⁾ Average service life: 100,000 h at T_U = +25 °C.

²⁾ In relation to long side of housing.

Adjustment of the sensitivity	Continuous: 0 ... 999
Available job banks	4
Safety-related parameters	
MTTF _D	263.7 years

¹⁾ Average service life: 100,000 h at T_U = +25 °C.

²⁾ In relation to long side of housing.

Interfaces

IO-Link	✓, IO-Link V1.1.2
VendorID	26
DeviceID HEX	80028E
DeviceID DEC	8389262
Digital output	Q ₁ , Q ₂
Number	2
Digital input	In ₁ , In ₂
Number	2

Electronics

Supply voltage	10.8 V DC ... 28.8 V DC ¹⁾
Ripple	≤ 5 V _{pp} ²⁾
Current consumption	< 120 mA ³⁾
Switching frequency	13.8 kHz
Response time	36 μs
Jitter	18 μs
Switching output	Push-pull: PNP/NPN
Switching output (voltage)	Push-pull: PNP/NPN HIGH = U _V - 3 V/LOW ≤ 3 V
Output current I_{max.}	100 mA ⁴⁾
Input, teach-in (ET)	Teach: U = 10 V ... < V _S
Input, blanking input (AT)	Blanked: U = 10 V ... < U _v
Retention time (ET)	3 s, non-volatile memory
Time delay	None
Protection class	III
Circuit protection	U _V connections, reverse polarity protected Output Q short-circuit protected Interference pulse suppression
Connection type	Plug, M12, 5-pin

¹⁾ Limit values: DC 12 V (-10 %) ... DC 24 V (+20 %). Operation in short-circuit protected network max. 8 A.

²⁾ May not fall below or exceed U_V tolerances.

³⁾ Without load.

⁴⁾ Total current of all Outputs.

Mechanics

Housing material	VISTAL®
-------------------------	---------

Optics material	PMMA
Weight	68 g

Ambient data

Ambient operating temperature	-20 °C ... +60 °C
Ambient temperature, storage	-25 °C ... +75 °C
Shock load	According to IEC 60068-2-27 (30 g/11 ms)
Enclosure rating	IP67
UL File No.	E181493

Connection type/pinouts

Connection type	Plug, M12, 5-pin	
Pinouts	BN 1	+ (L+)
	WH 2	Q _{L2} /IN ₁
	BU 3	- (M)
	BK 4	Q _{L1} /C
	GY 5	In ₂

Certificates

EU declaration of conformity	✓
UK declaration of conformity	✓
ACMA declaration of conformity	✓
Moroccan declaration of conformity	✓
China RoHS	✓
cULus certificate	✓
IO-Link certificate	✓
Photobiological safety (IEC EN 62471)	✓
Information according to Art. 3 of Data Act (Regulation EU 2023/2854)	✓

Classifications

ECLASS 5.0	27270907
ECLASS 5.1.4	27270907
ECLASS 6.0	27270907
ECLASS 6.2	27270907
ECLASS 7.0	27270907
ECLASS 8.0	27270907
ECLASS 8.1	27270907
ECLASS 9.0	27270907
ECLASS 10.0	27270907
ECLASS 11.0	27270907
ECLASS 12.0	27270907

ETIM 5.0	EC001817
ETIM 6.0	EC001817
ETIM 7.0	EC001817
ETIM 8.0	EC001817
UNSPSC 16.0901	39121528

Dimensional drawing, sensor

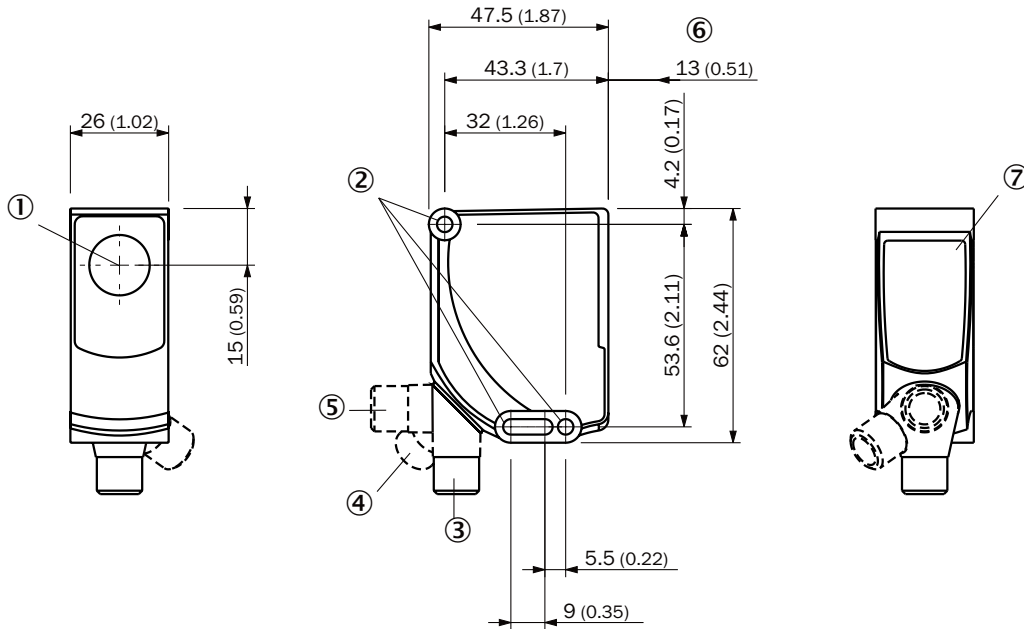

Dimensions in mm (inch)

- ① Optical axis
- ② fixing hole
- ③ M12 male connector, delivery state
- ④ M12 male connector, end stop right
- ⑤ M12 male connector, end stop left
- ⑥ Sensing distance
- ⑦ display and adjustment elements

Pinouts, see table [Technical data: Connection type/pinouts](#)

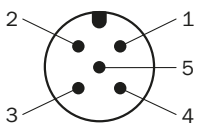

Male connector, M12, 5-pin, A-coded

display and adjustment elements

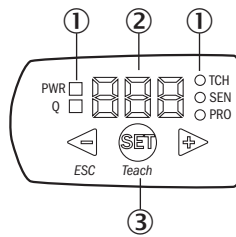







- ① LEDs (status display)
- ② 7-segment display
- ③ Plus/minus button

Recommended accessories

Other models and accessories → www.sick.com/CSS_CSX_High_Speed

	Brief description	Type	part no.
Mounting systems			
	<ul style="list-style-type: none"> • Description: Plate K for universal clamp bracket • Material: Steel • Details: Steel, zinc coated • Items supplied: Universal clamp (2022726), mounting hardware • Usable for: W11-2, W12-3, W14-2, W18-3, W23-2, W24-2, W27-3, W30, W32, W34, W36, PL50A, PL80A, P250, UC12, LUT3, KT2, KT5-2, KT8, CS8, DT2, DS30, DS40, W12-2 Laser, W16, W26, KT5 	BEF-KHS-K01	2022718

	Brief description	Type	part no.
network devices			
		IOLA2US-01101 (SiLink2 Master)	1061790
		SIG350-0004AP100	6076871
		SIG350-0005AP100	6076923
		SIG350-0006AP100	6076924
connectors and cables			
	<ul style="list-style-type: none"> • Description: Unshielded • Connection type head A: Male connector, M12, 5-pin, straight, A-coded • Connection systems: Screw-type terminals • Permitted cross-section: ≤ 0.75 mm² • Note: For field bus technology 	STE-1205-G	6022083
	<ul style="list-style-type: none"> • Description: Sensor/actuator cable, unshielded • Connection type head A: Female connector, M12, 5-pin, straight, A-coded • Connection type head B: Flying leads • Signal type: Sensor/actuator cable • Cable: 5 m, 5-wire, PVC • Application: Uncontaminated zones, Zones with chemicals 	YF2A15-050VB5XLEAX	2096240

SICK AT A GLANCE

SICK is one of the leading manufacturers of intelligent sensors and sensor solutions for industrial applications. A unique range of products and services creates the perfect basis for controlling processes securely and efficiently, protecting individuals from accidents and preventing damage to the environment.

We have extensive experience in a wide range of industries and understand their processes and requirements. With intelligent sensors, we can deliver exactly what our customers need. In application centers in Europe, Asia and North America, system solutions are tested and optimized in accordance with customer specifications. All this makes us a reliable supplier and development partner.

Comprehensive services complete our offering: SICK LifeTime Services provide support throughout the machine life cycle and ensure safety and productivity.

For us, that is “Sensor Intelligence.”

WORLDWIDE PRESENCE:

Contacts and other locations –www.sick.com