

SICK.COM



DATA SHEET

MLG05W-0858N12501

MLG-2 WebChecker
Automation light grids

SICK Sensor Intelligence

AUTOMATION LIGHT GRIDS

ML- G05W-0858N12501

ORDERING INFORMATION

Type	part no.
MLG05W-0858N12501	1118453

Further device versions and accessories at www.sick.com/MLG-2_WebChecker



Illustration may differ

DETAILED TECHNICAL DATA

FEATURES

Device version	Web guiding
Sensor principle	Sender/receiver
Minimum object length	4 mm ¹⁾
Beam separation	5 mm
Resolution	0.1 mm
Cycle time	32 µs per beam
Repeatability	6 µm ²⁾
Accuracy	± 0.3 mm ³⁾
Type of synchronization	Cable
Number of beams	480
Total measuring field width	3,145 mm
Measuring field width detailed	
Measuring field width (connection side)	1,195 mm
Blind zone (medium range)	755 mm
Measuring field width (head side)	1,195 mm
Software features (default)	
Q ₁ Alarm, general	
Application	Standard mode
Included with delivery	1 × sender 1 × receiver

¹⁾ See graphic: product definition.

²⁾ 1 Sigma, 0% object transmission (internal sensor value).

³⁾ Typically 0.1 mm. For opaque objects and exact alignment of sender/receiver.

1 x Fieldbus module
 4/6 x QuickFix brackets (6 x QuickFix brackets for monitoring heights above 2 m)
 1 x Quick Start Guide

¹⁾ See graphic: product definition.

²⁾ 1 Sigma, 0% object transmission (internal sensor value).

³⁾ Typically 0.1 mm. For opaque objects and exact alignment of sender/receiver.

MECHANICS/ELECTRONICS

Light source	LED, Infrared light
Wave length	850 nm
Supply voltage V_e	DC 19.2 V ... 28.8 V ¹⁾
Power consumption sender	79 mA ²⁾
Power consumption receiver	216 mA ²⁾
Fieldbus module current consumption	115 mA
Ripple	< 5 V _{pp}
Output current I_{max}	100 mA
Output load, capacitive	100 nF
Output load, Inductive	1 H
Initialization time	< 1 s
Switching output	Push-pull: PNP/NPN
Dimensions (W x H x D)	34 mm x 3,229.4 mm x 30.6 mm
Connection type	Plug, M12, 5-pin, 0.22 m Connector M12, 12-pin, 0.27 m
Housing material	Aluminum
Display	LED
Enclosure rating	IP65, IP67 ³⁾
Circuit protection	U_v connections, reverse polarity protected Output Q short-circuit protected Interference pulse suppression
Protection class	III
Weight	6.559 kg
Front screen	PMMA
Option	None
UL File No.	NRKH.E181493

¹⁾ Without load.

²⁾ Without load with 24 V.

³⁾ Operating in outdoor condition only with a external protection housing.

PERFORMANCE

Maximum range	3.5 m ¹⁾
Minimum range	≥ 0.2 m
Operating range	2.5 m
Response time	95.8 ms ²⁾

¹⁾ No reserve for environmental issue and deterioration of the diode.

²⁾ With resistive load.

INTERFACES

PROFINET	✓
Digital output	Q ₁
Number	1

AMBIENT DATA

Shock resistance	Continuous shocks 10 g, 16 ms, 1000 shocks Single shocks 15 g, 11 ms 3 per axle
Vibration resistance	Sinusoidal oscillation 10-150 Hz 5 g
Ambient light immunity	100,000 lx
Ambient operating temperature	-30 °C ... +55 °C
Ambient temperature, storage	-40 °C ... +70 °C

CERTIFICATES

EU declaration of conformity	✓
UK declaration of conformity	✓
ACMA declaration of conformity	✓
Moroccan declaration of conformity	✓
China RoHS	✓
cULus certificate	✓
Profinet certificate	✓
Photobiological safety (IEC EN 62471)	✓
Information according to Art. 3 of Data Act (Regulation EU 2023/2854)	✓

DIMENSIONAL DRAWING



Dimensions in mm (inch)

- ① First beam
- ② last beam
- ③ total measuring field width (see technical data)
- ④ Beam separation
- ⑤ Optical axis
- ⑥ status indicator: green, yellow, red LEDs
- ⑦ Connection

DIMENSIONAL DRAWING PROFINET, ETHERCAT®, ETHERNET/IP



Dimensions in mm (inch)

- ① safty screw M4; turning moment 0,5 Nm
- ② for thread bold M4; turning moment 0,5 Nm

CONNECTION TYPE AND DIAGRAM MLG-2 WEBCHECKER



① Connection to fieldbus module

PINOUPS ETHERNET

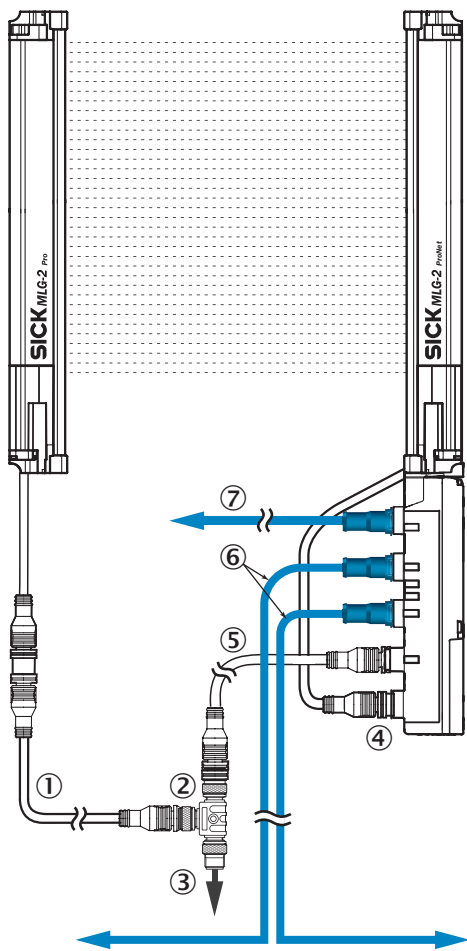

- ① Connection cable receiver (2096010)
- ② T-piece
- ③ Connection cable (2096240)
- ④ connection receiver "DEVICE"
- ⑤ Connection cable "POWER" (2096010)
- ⑥ Ethernet Connection cable "BUS IN, BUS OUT"
- ⑦ Ethernet connection cable "CONFIG"

ADJUSTMENTS



① status indicator: green, yellow, red LEDs

CONNECTION DIAGRAM T-PIECE



PRODUCT DEFINITION

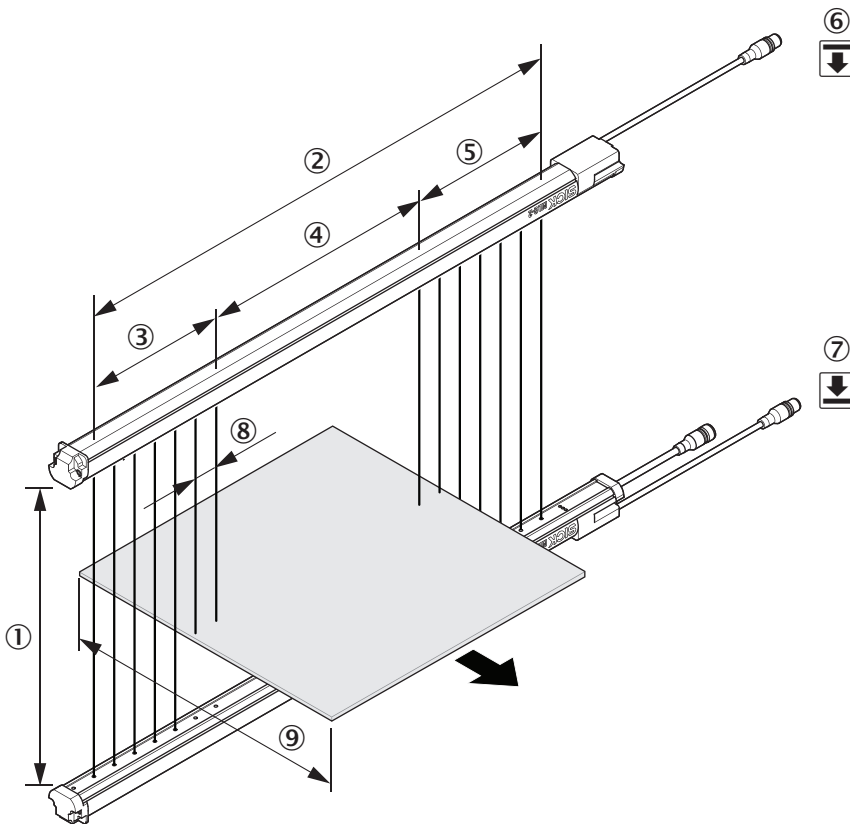

- ① operating range
- ② total measuring field width
- ③ measuring field width (head side)
- ④ Blind zone (medium range)
- ⑤ measuring field width (connection side)
- ⑥ sender
- ⑦ receiver
- ⑧ Beam separation
- ⑨ minimum object length

Further information as well as suitable accessories, example applications and downloads such as CAD dimensional models, operating instructions and software can be found at www.sick.com/1118453



SICK AG
WALDKIRCH
GERMANY
SICK.COM

SICK AT A GLANCE

SICK is a leading global technology company for intelligent sensors and integrated solutions in industrial automation. Our technologies set benchmarks, making your industrial processes more efficient, safer and more sustainable – both in logistics and manufacturing operations.

SICK combines sensor intelligence with industry expertise and certified consulting services. We provide the ideal foundation for scalable as well as tailor-made automation solutions and create added value along the entire value chain. Our close partnerships with our customers are more than just a promise: Together, we optimize productivity, improve quality, protect health and safety, and help build a sustainable future. All with empathy and trust.

Since 1946, we have been developing innovative technologies with passion and a pioneering spirit. With a global network in around 40 countries, SICK has a global presence and is always close by. The company's headquarters are located in Waldkirch near Freiburg, Germany. Our customers benefit from our understanding of both local and global requirements, which enables us to deliver tailor-made solutions

SICK
Sensor Intelligence