

SICK.COM

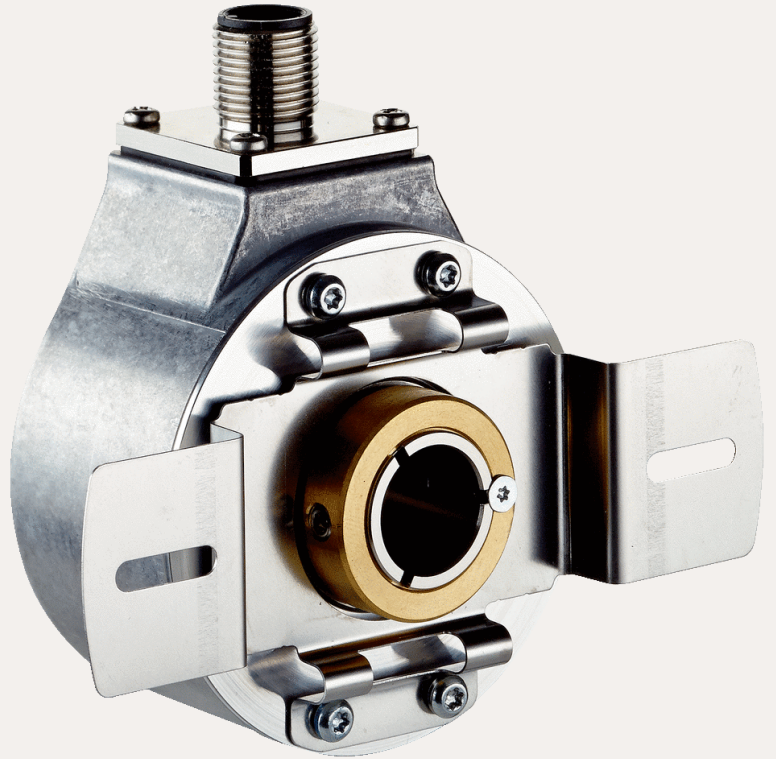

DATA SHEET

DBS60E-BBAC01000

DBS60
Incremental encoders

SICK Sensor Intelligence

INCREMENTAL ENCODERS

DBS60E-BBAC01000

ORDERING INFORMATION

| Type | part no. |
|------------------|----------|
| DBS60E-BBAC01000 | 1116545 |

Further device versions and accessories at www.sick.com/DBS60

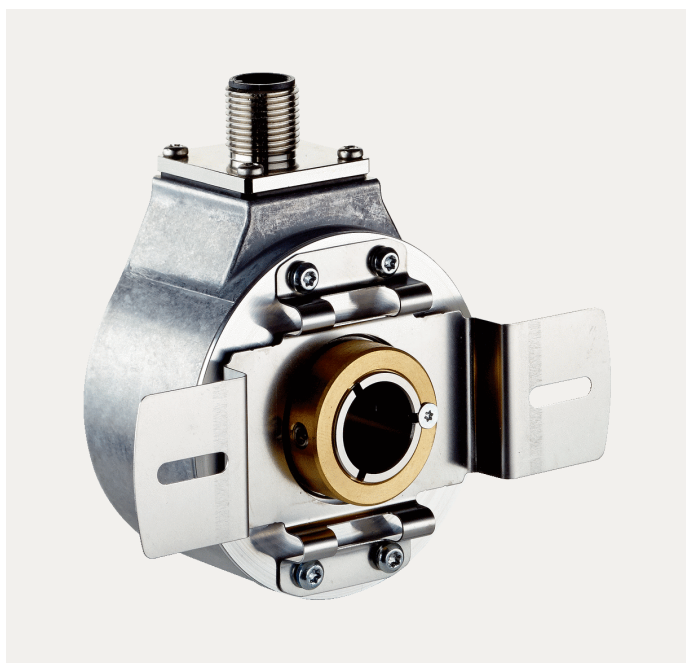

Illustration may differ



DETAILED TECHNICAL DATA

SAFETY-RELATED PARAMETERS

| | |
|--|--|
| MTTF _D (mean time to dangerous failure) | 500 years (EN ISO 13849-1) ¹⁾ |
|--|--|

¹⁾ This product is a standard product and does not constitute a safety component as defined in the Machinery Directive. Calculation based on nominal load of components, average ambient temperature 40°C, frequency of use 8760 h/a. All electronic failures are considered hazardous. For more information, see document no. 8015532.

PERFORMANCE

| | |
|--------------------------|---------------------------------------|
| Pulses per revolution | 1,000 |
| Measuring step | ≤ 90°, electric/pulses per revolution |
| Measuring step deviation | ± 18° / pulses per revolution |
| Error limits | Measuring step deviation x 3 |
| Duty cycle | ≤ 0.5 ± 5 % |

INTERFACES

| | |
|--------------------------------|-------------------------|
| Communication interface | Incremental |
| Communication Interface detail | TTL / RS-422 |
| Number of signal channels | 6-channel |
| Initialization time | < 5 ms ¹⁾ |
| Output frequency | + 300 kHz ²⁾ |
| Load current | ≤ 30 mA, per channel |

¹⁾ Valid signals can be read once this time has elapsed.

²⁾ Up to 450 kHz on request.

| | |
|-------------------|------------------------|
| Operating current | ≤ 50 mA (without load) |
|-------------------|------------------------|

¹⁾ Valid signals can be read once this time has elapsed.

²⁾ Up to 450 kHz on request.

ELECTRONICS

| | |
|---|---|
| Connection type | Male connector, M12, 8-pin, radial |
| Supply voltage | 4.5 ... 5.5 V |
| Reference signal, number | 1 |
| Reference signal, position | 90°, electric, logically gated with A and B |
| Reverse polarity protection | ✓ |
| Short-circuit protection of the outputs | ✓ ¹⁾ |

¹⁾ Short-circuit opposite to another channel or GND permissible for max. 60 s. No protection signal against U_g .

MECHANICS

| | |
|--------------------------------|---|
| Mechanical design | Blind hollow shaft |
| Shaft diameter | 8 mm Front clamp |
| Flange type / stator coupling | 2-sided stator coupling, slot, screw hole circle 63–83 mm |
| Weight | + 0.25 kg ¹⁾ |
| Shaft material | Stainless steel |
| Flange material | Aluminum |
| Housing material | Aluminum |
| Start up torque | + 0.5 Ncm (+20 °C) |
| Operating torque | 0.4 Ncm (+20 °C) |
| Permissible movement static | ± 0.3 mm (radial) ± 0.5 mm (axial) ²⁾ |
| Permissible movement dynamic | ± 0.1 mm (radial) ± 0.2 mm (axial) ²⁾ |
| Operating speed | 6,000 min ⁻¹ ³⁾ |
| Maximum operating speed | 9,000 min ⁻¹ ⁴⁾ |
| Moment of inertia of the rotor | 50 gcm ² |
| Bearing lifetime | 3.6 x 10 ⁹ revolutions |
| Angular acceleration | ≤ 500,000 rad/s ² |

¹⁾ Based on encoder with male connector or cable with male connector.

²⁾ Not applicable for stator coupling type C and K.

³⁾ Allow for self-heating of 2.6 K per 1,000 rpm when designing the operating temperature range.

⁴⁾ Maximum speed which does not cause mechanical damage to the encoder. Impact on the service life and signal quality is possible. Please note the maximum output frequency.

AMBIENT DATA

| | |
|-------------------------------|--|
| EMC | According to EN 61000-6-2 and EN 61000-6-3 |
| Enclosure rating | IP67, housing side (IEC 60529) ¹⁾ IP65, shaft side (IEC 60529) |
| Permissible relative humidity | 90 % (Condensation not permitted) |
| Operating temperature range | -20 °C ... +85 °C ²⁾ |
| Storage temperature range | -40 °C ... +100 °C, without package |

¹⁾ With mating connector fitted.

²⁾ These values relate to all mechanical versions including recommended accessories unless otherwise noted.

INCREMENTAL ENCODERS - DBS60E-BBAC01000

| | |
|-------------------------|---|
| Resistance to shocks | 250 g, 3 ms (EN 60068-2-27) |
| Resistance to vibration | 30 g, 10 Hz ... 2,000 Hz (EN 60068-2-6) |

¹ With mating connector fitted.

² These values relate to all mechanical versions including recommended accessories unless otherwise noted.

CERTIFICATES

| | |
|---|---|
| EU declaration of conformity | ✓ |
| UK declaration of conformity | ✓ |
| ACMA declaration of conformity | ✓ |
| China RoHS | ✓ |
| cULus certificate | ✓ |
| Information according to Art. 3 of Data Act (Regulation EU 2023/2854) | ✓ |

DIMENSIONAL DRAWING

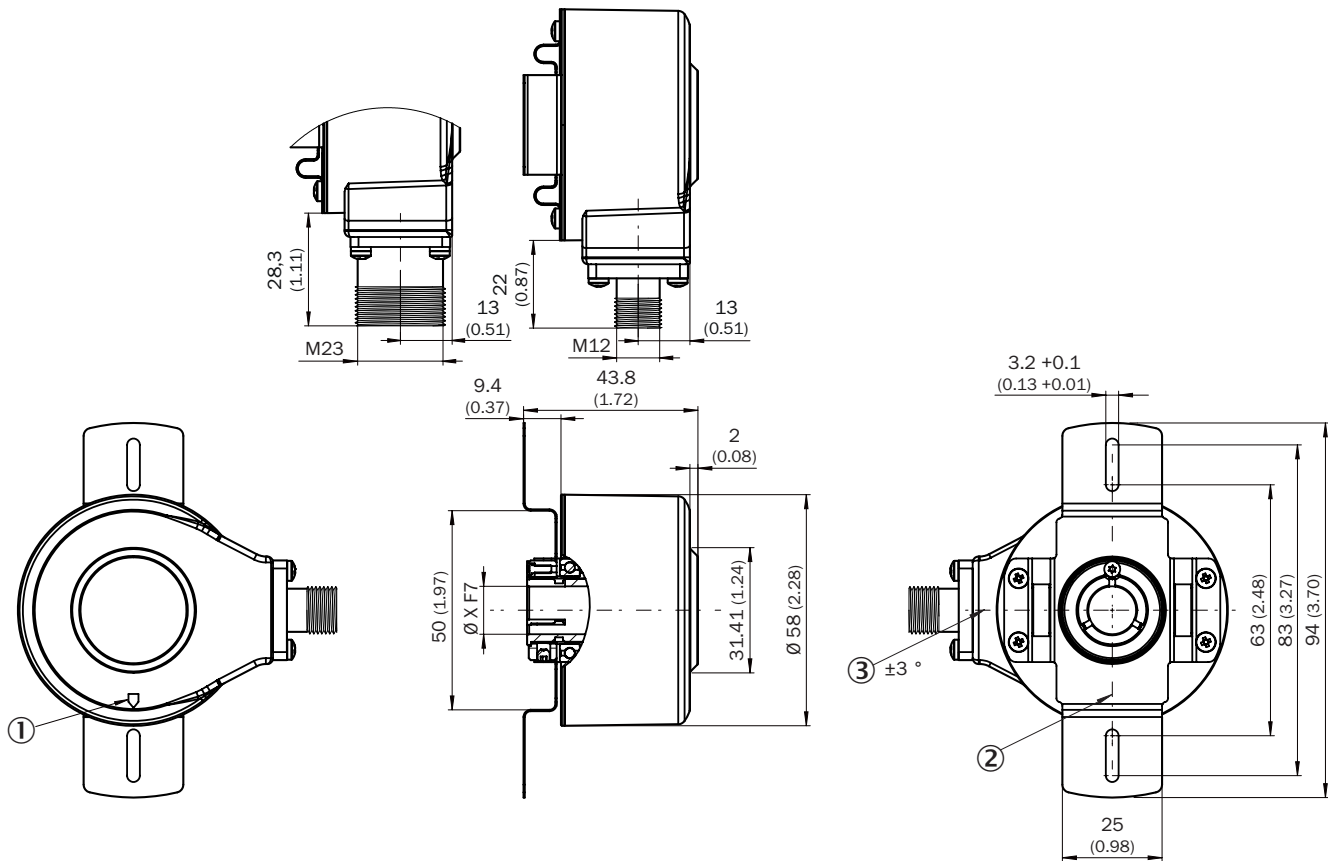

Dimensions in mm (inch)

- ① Zero pulse mark on housing
- ② zero pulse mark on flange under stator coupling
- ③ male connector tolerance in relation to hole pattern

| Type | Blind hollow shaft | Shaft diameter XF7 |
|------------------|--------------------|--------------------|
| DBS60x-BAxxxxxxx | | 6 mm |
| DBS60x-B1xxxxxxx | | 6 mm |
| DBS60x-BBxxxxxxx | | 8 mm |
| DBS60x-B2xxxxxxx | | 8 mm |
| DBS60x-BCxxxxxxx | | 3/8" |

| TypeBlind hollow shaft | Shaft diameter XF7 |
|--|--------------------|
| DBS60x-B3xxxxxxxx | |
| DBS60x-BDxxxxxxxx DBS60x-B4xxxxxxxx | 10 mm |
| DBS60x-BExxxxxxxx DBS60x-B5xxxxxxxx | 12 mm |
| DBS60x-BFxxxxxxxx DBS60x-B6xxxxxxxx | 1/2" |
| DBS60x-BGxxxxxxxx DBS60x-B7xxxxxxxx | 14 mm |
| DBS60x-BHxxxxxxxx DBS60x-B8xxxxxxxx | 15 mm |
| DBS60x-BJxxxxxxxx | 5/8" |
| - | |

ATTACHMENT SPECIFICATIONS BLIND HOLLOW SHAFT

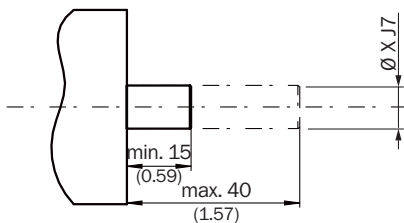

customer side

| TypeBlind hollow shaft | Shaft diameter xj7 |
|--|--------------------|
| DBS60x-BAxxxxxxxx DBS60x-B1xxxxxxxx | 6 mm |
| DBS60x-BBxxxxxxxx DBS60x-B2xxxxxxxx | 8 mm |
| DBS60x-BCxxxxxxxx DBS60x-B3xxxxxxxx | 3/8" |
| DBS60x-BDxxxxxxxx DBS60x-B4xxxxxxxx | 10 mm |
| DBS60x-BExxxxxxxx DBS60x-B5xxxxxxxx | 12 mm |
| DBS60x-BFxxxxxxxx DBS60x-B6xxxxxxxx | 1/2" |
| DBS60x-BGxxxxxxxx DBS60x-B7xxxxxxxx | 14 mm |
| DBS60x-BHxxxxxxxx DBS60x-B8xxxxxxxx | 15 mm |
| DBS60x-BJxxxxxxxx | 5/8" |
| - | |

PIN ASSIGNMENT

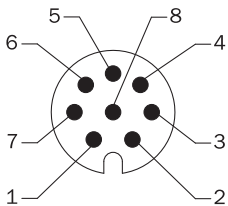

view of M12 male device connector on cable / housing

| Wire colors (cable connection) | Male connector M12, 8-pin | Male connector M23, 12-pin | TTL/HTL 6-channel signal | Explanation |
|--------------------------------|---------------------------|----------------------------|--------------------------|-------------------------------------|
| Brown | 1 | 6 | A- | Signal wire |
| White | 2 | 5 | A | Signal wire |
| Black | 3 | 1 | B- | Signal wire |
| Pink | 4 | 8 | B | Signal wire |
| Yellow | 5 | 4 | Z- | Signal wire |
| Purple | 6 | 3 | Z | Signal wire |
| Blue | 7 | 10 | GND | Ground connection |
| Red | 8 | 12 | +U _s | Supply voltage |
| - | - | 9 | Not assigned | Not assigned |
| - | - | 2 | Not assigned | Not assigned |
| - | - | 11 | Not assigned | Not assigned |
| - | - | 7 | Not assigned | Not assigned |
| Screen | Screen | Screen | Screen | Screen connected to encoder housing |

DIAGRAMS

Pulses per revolution

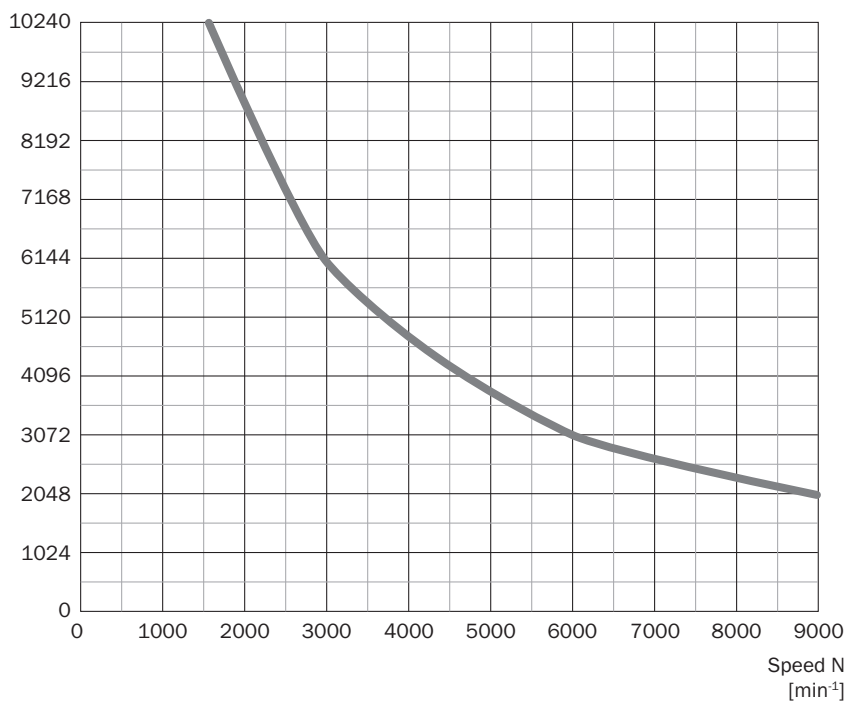

DIAGRAMS SIGNAL OUTPUTS FOR ELECTRICAL INTERFACES TTL AND HTL

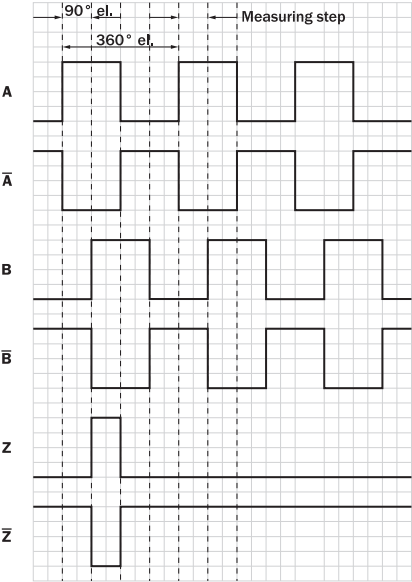

Cw with view on the encoder shaft in direction "A", compare dimensional drawing.

| Supply voltage | Output |
|-----------------|-------------------|
| 4,5 V ... 5,5 V | TTL |
| 10 V ... 30 V | TTL |
| 10 V ... 27 V | HTL |
| 4,5 V ... 30 V | TTL/HTL universal |
| 4,5 V ... 30 V | TTL |

Further information as well as suitable accessories, example applications and downloads such as CAD dimensional models, operating instructions and software can be found at www.sick.com/1116545



SICK AG
WALDKIRCH
GERMANY
SICK.COM

SICK AT A GLANCE

SICK is a leading global technology company for intelligent sensors and integrated solutions in industrial automation. Our technologies set benchmarks, making your industrial processes more efficient, safer and more sustainable – both in logistics and manufacturing operations.

SICK combines sensor intelligence with industry expertise and certified consulting services. We provide the ideal foundation for scalable as well as tailor-made automation solutions and create added value along the entire value chain. Our close partnerships with our customers are more than just a promise: Together, we optimize productivity, improve quality, protect health and safety, and help build a sustainable future. All with empathy and trust.

Since 1946, we have been developing innovative technologies with passion and a pioneering spirit. With a global network in around 40 countries, SICK has a global presence and is always close by. The company's headquarters are located in Waldkirch near Freiburg, Germany. Our customers benefit from our understanding of both local and global requirements, which enables us to deliver tailor-made solutions

SICK
Sensor Intelligence