



IHM06-1B5PSVT0K

IMM

INDUCTIVE PROXIMITY SENSORS

SICK
Sensor Intelligence.



Ordering information

Type	part no.
IHM06-1B5PSVT0K	1114596

Other models and accessories → www.sick.com/IMM

Illustration may differ



Detailed technical data

Features

Housing	Cylindrical
Housing	Short-body
Diameter	Ø 6.5 mm
Sensing range S_n	1.5 mm
Safe sensing range S_a	1.215 mm
Installation type	Flush
Switching frequency	5,000 Hz
Connection type	Connector M8, 3-pin
Switching output	PNP
Switching output detail	PNP
Output function	NO
Electrical wiring	DC 3-wire
Enclosure rating	IP67 ¹⁾
Special features	Visual adjustment indicator

¹⁾ According to EN 60529.

Mechanics/electronics

Supply voltage	10 V DC ... 30 V DC
Ripple	≤ 20 % ¹⁾

¹⁾ Of V_S.

²⁾ With I_a = 200 mA.

³⁾ Supply voltage U_B and constant ambient temperature T_a.

Voltage drop	$\leq 2 \text{ V}^{2)}$
Time delay before availability	$\leq 50 \text{ ms}$
Hysteresis	1 % ... 10 %
Reproducibility	$\leq 2 \%^{3)}$
Temperature drift (of S_r)	$\leq 10 \%$
EMC	EN 60947-5-2
Continuous current I_a	$\leq 200 \text{ mA}$
Short-circuit protection	✓
Power-up pulse protection	✓
Shock and vibration resistance	30 g, 11 ms / 10 ... 55 Hz, 1 mm
Ambient operating temperature	-25 °C ... +70 °C
Housing material	Stainless steel V2A, DIN 1.4305 / AISI 303
Sensing face material	Plastic, LCP
Housing length	40 mm
UL File No.	NRKH.E348498

1) Of V_S .

2) With $I_a = 200 \text{ mA}$.

3) Supply voltage U_B and constant ambient temperature T_a .

Safety-related parameters

MTTF_D	1,330 years
DC_{avg}	0 %

Communication interface

Communication interface	IO-Link V1.1
Communication Interface detail	COM2 (38,4 kBaud)
Cycle time	10.4 ms
Process data length	1 Byte
Process data structure	Bit 0 = S_r reached Bit 1 = S_a reached

Reduction factors

Note	The values are reference values which may vary
St37 steel (Fe)	1
Stainless steel (V2A, 304)	Approx. 0.75
Aluminum (Al)	Approx. 0.5
Copper (Cu)	Approx. 0.43
Brass (Br)	Approx. 0.54

Installation note

Remark	Associated graphic see "Installation"
B	6 mm
C	6.5 mm
D	4.5 mm
F	12 mm

Certificates

EU declaration of conformity	✓
UK declaration of conformity	✓
ACMA declaration of conformity	✓
Moroccan declaration of conformity	✓
China RoHS	✓
cULus certificate	✓
IO-Link certificate	✓
Information according to Art. 3 of Data Act (Regulation EU 2023/2854)	✓

Classifications

ECLASS 5.0	27270101
ECLASS 5.1.4	27270101
ECLASS 6.0	27270101
ECLASS 6.2	27270101
ECLASS 7.0	27270101
ECLASS 8.0	27270101
ECLASS 8.1	27270101
ECLASS 9.0	27270101
ECLASS 10.0	27270101
ECLASS 11.0	27270101
ECLASS 12.0	27274001
ETIM 5.0	EC002714
ETIM 6.0	EC002714
ETIM 7.0	EC002714
ETIM 8.0	EC002714
UNSPSC 16.0901	39122230

Installation note Mounting using BEF-KH-M06 bracket

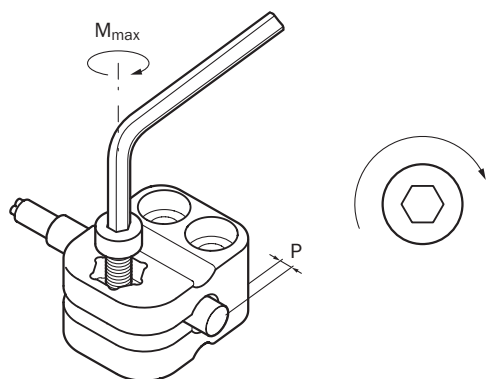

Sensor type	Mounting adapter	Overrun (P)	Max. tightening torque (M_{max})
IHM06-1B5*****	BEF-KH-M06, part no. 2101067	≥ 0 mm	≤ 0.6 Nm

Sensor type	Mounting adapter	Overrun (P)	Max. tightening torque (M_{max})
IHM06-02B***** IHM06-03B*****			

Installation note Fixing with setscrew

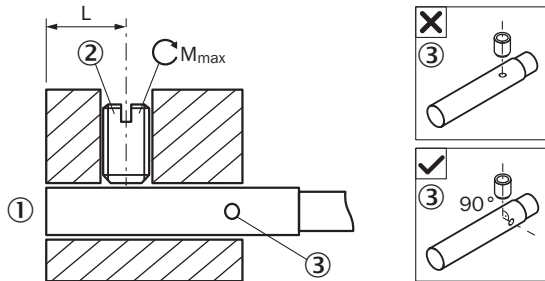

- ① Sensing face
- ② Recommended setscrew: M3, flat point
- ③ Display LED

Sensor type	Mounting area (L)	Max. tightening torque (M_{max})
IHM06-*****G	6 mm ... 11 mm	≤ 0.4 Nm
IHM06-*****TOG	6 mm ... 21 mm	≤ 0.4 Nm
IHM06-*****K	6 mm ... 21 mm	≤ 0.4 Nm
IHM06-*****TOK	6 mm ... 32 mm	≤ 0.4 Nm
IHM06-*****S	6 mm ... 32 mm	≤ 0.4 Nm
IHM06-*****TOS	6 mm ... 42 mm	≤ 0.4 Nm

Installation note Flush installation

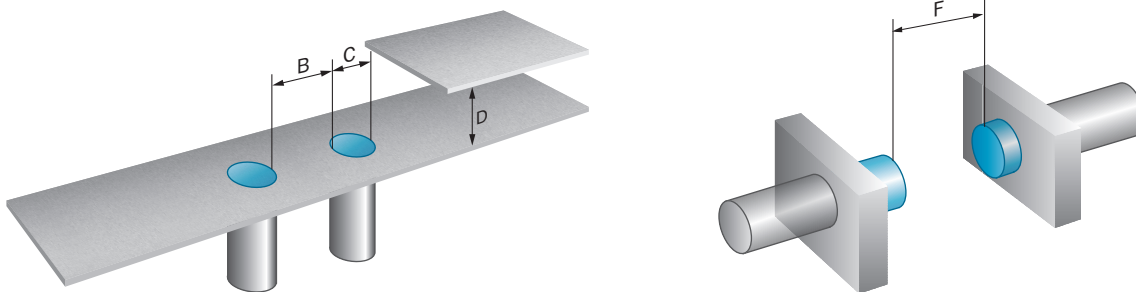

Connection diagram Cd-002

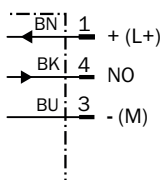

Response diagram

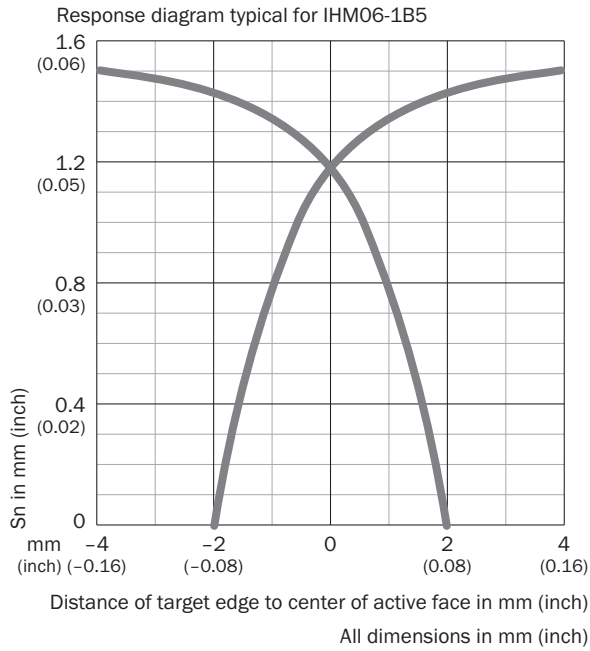

Functional principle Installation aid



Dimensional drawing IHM06, short variant, flush, male connector

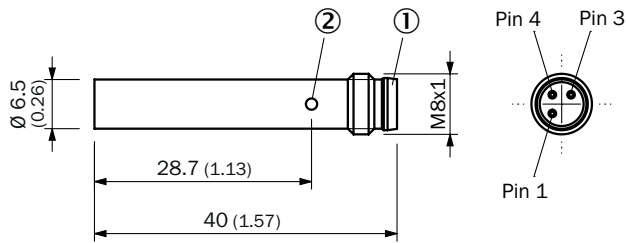





Recommended accessories

Other models and accessories → www.sick.com/IMM

	Brief description	Type	part no.
Mounting systems			
	<ul style="list-style-type: none">• Material: Plastic• Details: Plastic (PA6)• Items supplied: Without mounting hardware• Usable for: Round sensors with 6.5 mm housing diameter without fixed stop	BEF-KH-M06	2101067

	Brief description	Type	part no.
connectors and cables			
	<ul style="list-style-type: none"> • Number of slots: 4 • Slot connection type: M8, 3-pin, A-coded, female connector • Items supplied: 5 x labeling plates • Description: Unshielded 	Y8A34A2-C2A8000XXX	2115733
	<ul style="list-style-type: none"> • Number of slots: 4 • Slot connection type: M8, 3-pin, A-coded, female connector • Items supplied: 5 x labeling plates • Cable: 5 m, 6-wire, PUR, halogen-free • Description: Unshielded • Application: Drag chain operation 	Y8A34A2-LXXXUAA050	2115727
	<ul style="list-style-type: none"> • Number of slots: 6 • Slot connection type: M8, 3-pin, A-coded, female connector • Items supplied: 5 x labeling plates • Description: Unshielded 	Y8A36A2-C2A8000XXX	2115734
	<ul style="list-style-type: none"> • Number of slots: 6 • Slot connection type: M8, 3-pin, A-coded, female connector • Items supplied: 5 x labeling plates • Cable: 5 m, 8-wire, PUR, halogen-free • Description: Unshielded • Application: Drag chain operation 	Y8A36A2-LXXXUBA050	2115728
	<ul style="list-style-type: none"> • Description: Sensor/actuator cable, unshielded • Connection type head A: Female connector, M8, 3-pin, straight, A-coded • Connection type head B: Flying leads • Signal type: Sensor/actuator cable • Cable: 2 m, 3-wire, PUR, halogen-free • Application: Drag chain operation, Zones with oils and lubricants, Robot, Drag chain operation 	YF8U13-020UA1XLEAX	2094782
	<ul style="list-style-type: none"> • Description: Sensor/actuator cable, unshielded • Connection type head A: Female connector, M8, 3-pin, straight, A-coded • Connection type head B: Flying leads • Signal type: Sensor/actuator cable • Cable: 5 m, 3-wire, PUR, halogen-free • Application: Drag chain operation, Zones with oils and lubricants, Robot, Drag chain operation 	YF8U13-050UA1XLEAX	2094788
	<ul style="list-style-type: none"> • Description: Sensor/actuator cable, unshielded • Connection type head A: Female connector, M8, 3-pin, straight, A-coded • Connection type head B: Flying leads • Signal type: Sensor/actuator cable • Cable: 2 m, 3-wire, PVC • Application: Uncontaminated zones, Zones with chemicals 	YF8U13-020VA1XLEAX	2095860
	<ul style="list-style-type: none"> • Description: Sensor/actuator cable, unshielded • Connection type head A: Female connector, M8, 3-pin, straight, A-coded • Connection type head B: Flying leads • Signal type: Sensor/actuator cable • Cable: 5 m, 3-wire, PVC • Application: Uncontaminated zones, Zones with chemicals 	YF8U13-050VA1XLEAX	2095884
	<ul style="list-style-type: none"> • Description: Sensor/actuator cable, unshielded • Connection type head A: Female connector, M8, 3-pin, angled, A-coded • Connection type head B: Flying leads • Signal type: Sensor/actuator cable • Cable: 2 m, 3-wire, PUR, halogen-free • Application: Drag chain operation, Zones with oils and lubricants, Robot, Drag chain operation 	YG8U13-020UA1XLEAX	2094794
	<ul style="list-style-type: none"> • Description: Sensor/actuator cable, unshielded • Connection type head A: Female connector, M8, 3-pin, angled, A-coded • Connection type head B: Flying leads • Signal type: Sensor/actuator cable • Cable: 5 m, 3-wire, PUR, halogen-free • Application: Drag chain operation, Zones with oils and lubricants, Robot, Drag chain operation 	YG8U13-050UA1XLEAX	2095586
	<ul style="list-style-type: none"> • Description: Sensor/actuator cable, unshielded • Connection type head A: Female connector, M8, 3-pin, angled, A-coded • Connection type head B: Flying leads • Signal type: Sensor/actuator cable • Cable: 2 m, 3-wire, PVC 	YG8U13-020VA1XLEAX	2096165

	Brief description	Type	part no.
	<ul style="list-style-type: none"> Application: Uncontaminated zones, Zones with chemicals Description: Sensor/actuator cable, unshielded Connection type head A: Female connector, M8, 3-pin, angled, A-coded Connection type head B: Flying leads Signal type: Sensor/actuator cable Cable: 5 m, 3-wire, PVC Application: Uncontaminated zones, Zones with chemicals 	YG8U13-050VA1XLEAX	2096166
	<ul style="list-style-type: none"> Description: Sensor/actuator cable, unshielded Connection type head A: Female connector, M8, 3-pin, straight, A-coded Connection type head B: Male connector, M12, 3-pin, straight, A-coded Signal type: Sensor/actuator cable Cable: 2 m, 3-wire, PUR, halogen-free Application: Drag chain operation, Zones with oils and lubricants, Robot, Drag chain operation 	YF8U13-020UA1M2A13	2096169
	<ul style="list-style-type: none"> Description: Sensor/actuator cable, unshielded Connection type head A: Female connector, M8, 3-pin, straight, A-coded Connection type head B: Male connector, M12, 3-pin, straight, A-coded Signal type: Sensor/actuator cable Cable: 5 m, 3-wire, PUR, halogen-free Application: Drag chain operation, Zones with oils and lubricants, Robot, Drag chain operation 	YF8U13-050UA1M2A13	2096170
	<ul style="list-style-type: none"> Description: Sensor/actuator cable, unshielded Connection type head A: Female connector, M8, 3-pin, straight, A-coded Connection type head B: Male connector, M12, 3-pin, straight, A-coded Signal type: Sensor/actuator cable Cable: 2 m, 3-wire, PVC Application: Uncontaminated zones, Zones with chemicals 	YF8U13-020VA1M2A13	2096605
	<ul style="list-style-type: none"> Description: Sensor/actuator cable, unshielded Connection type head A: Female connector, M8, 3-pin, straight, A-coded Connection type head B: Male connector, M12, 3-pin, straight, A-coded Signal type: Sensor/actuator cable Cable: 5 m, 3-wire, PVC Application: Uncontaminated zones, Zones with chemicals 	YF8U13-050VA1M2A13	2096606
	<ul style="list-style-type: none"> Description: Sensor/actuator cable, unshielded Connection type head A: Female connector, M8, 3-pin, angled, A-coded Connection type head B: Male connector, M12, 3-pin, straight, A-coded Signal type: Sensor/actuator cable Cable: 2 m, 3-wire, PUR, halogen-free Application: Drag chain operation, Zones with oils and lubricants, Robot, Drag chain operation 	YG8U13-020UA1M2A13	2095748
	<ul style="list-style-type: none"> Description: Sensor/actuator cable, unshielded Connection type head A: Female connector, M8, 3-pin, straight, A-coded Connection type head B: Male connector, M8, 3-pin, straight, A-coded Signal type: Sensor/actuator cable Cable: 2 m, 3-wire, PUR, halogen-free Application: Drag chain operation, Zones with oils and lubricants, Robot, Drag chain operation 	YF8U13-020UA1M8U13	2096304
	<ul style="list-style-type: none"> Description: Sensor/actuator cable, unshielded Connection type head A: Female connector, M8, 3-pin, straight, A-coded Connection type head B: Male connector, M8, 3-pin, straight, A-coded Signal type: Sensor/actuator cable Cable: 5 m, 3-wire, PUR, halogen-free Application: Drag chain operation, Zones with oils and lubricants, Robot, Drag chain operation 	YF8U13-050UA1M8U13	2096308
	<ul style="list-style-type: none"> Description: Sensor/actuator cable, unshielded Connection type head A: Female connector, M8, 3-pin, angled, A-coded Connection type head B: Male connector, M8, 3-pin, straight, A-coded Signal type: Sensor/actuator cable Cable: 2 m, 3-wire, PUR, halogen-free Application: Drag chain operation, Zones with oils and lubricants, Robot, Drag chain operation 	YG8U13-020UA1M8U13	2107781
	<ul style="list-style-type: none"> Description: Sensor/actuator cable, unshielded Connection type head A: Female connector, M8, 3-pin, angled, A-coded Connection type head B: Male connector, M12, 3-pin, straight, A-coded Signal type: Sensor/actuator cable Cable: 5 m, 3-wire, PUR, halogen-free Application: Drag chain operation, Zones with oils and lubricants, Robot, Drag chain operation 	YG8U13-050UA1M2A13	2122842
	<ul style="list-style-type: none"> Description: Sensor/actuator cable, unshielded Connection type head A: Female connector, M8, 3-pin, straight, A-coded Connection type head B: Male connector, M12, 3-pin, straight, A-coded Signal type: Sensor/actuator cable Cable: 3 m, 3-wire, PUR, halogen-free 	YF8U13-030UA1M2A13	2144589

	Brief description	Type	part no.
	<ul style="list-style-type: none"> Application: Drag chain operation, Zones with oils and lubricants, Robot, Drag chain operation Description: Sensor/actuator cable, unshielded Connection type head A: Female connector, M8, 3-pin, angled, A-coded Connection type head B: Flying leads Signal type: Sensor/actuator cable Cable: 0.6 m, 3-wire, PUR, halogen-free Application: Drag chain operation, Zones with oils and lubricants, Robot, Drag chain operation 	YG8U13-C60UA1XLEAX	2145889
	<ul style="list-style-type: none"> Description: Sensor/actuator cable, unshielded Connection type head A: Female connector, M8, 3-pin, angled, A-coded Connection type head B: Flying leads Signal type: Sensor/actuator cable Cable: 3 m, 3-wire, PUR, halogen-free Application: Drag chain operation, Zones with oils and lubricants, Robot, Drag chain operation 	YG8U13-030UA1XLEAX	2145891
	<ul style="list-style-type: none"> Description: Sensor/actuator cable, unshielded Connection type head A: Female connector, M8, 3-pin, straight, A-coded Connection type head B: Flying leads Signal type: Sensor/actuator cable Cable: 0.6 m, 3-wire, PVC Application: Uncontaminated zones, Zones with chemicals 	YF8U13-C60VA1XLEAX	2146368
	<ul style="list-style-type: none"> Description: Sensor/actuator cable, unshielded Connection type head A: Female connector, M8, 3-pin, straight, A-coded Connection type head B: Male connector, M12, 3-pin, straight, A-coded Signal type: Sensor/actuator cable Cable: 1 m, 3-wire, PVC Application: Uncontaminated zones, Zones with chemicals 	YF8U13-010VA1M2A13	2146381
	<ul style="list-style-type: none"> Description: Sensor/actuator cable, unshielded Connection type head A: Female connector, M8, 3-pin, angled, A-coded Connection type head B: Male connector, M12, 3-pin, straight, A-coded Signal type: Sensor/actuator cable Cable: 2 m, 3-wire, PUR, halogen-free Application: Drag chain operation, Zones with oils and lubricants, Robot, Drag chain operation 	YI8U13-020UA1M2A13	2153825

SICK AT A GLANCE

SICK is one of the leading manufacturers of intelligent sensors and sensor solutions for industrial applications. A unique range of products and services creates the perfect basis for controlling processes securely and efficiently, protecting individuals from accidents and preventing damage to the environment.

We have extensive experience in a wide range of industries and understand their processes and requirements. With intelligent sensors, we can deliver exactly what our customers need. In application centers in Europe, Asia and North America, system solutions are tested and optimized in accordance with customer specifications. All this makes us a reliable supplier and development partner.

Comprehensive services complete our offering: SICK LifeTime Services provide support throughout the machine life cycle and ensure safety and productivity.

For us, that is “Sensor Intelligence.”

WORLDWIDE PRESENCE:

Contacts and other locations –www.sick.com