

# IHM04-0B8POVU2S

IMM

INDUCTIVE PROXIMITY SENSORS

**SICK**  
Sensor Intelligence.



### Ordering information

Type	part no.
IHM04-OB8POVU2S	1114512

Other models and accessories → [www.sick.com/IMM](http://www.sick.com/IMM)

Illustration may differ



### Detailed technical data

#### Features

<b>Housing</b>	Cylindrical
<b>Housing</b>	Standard design
<b>Diameter</b>	Ø 4 mm
<b>Sensing range <math>S_n</math></b>	0.8 mm
<b>Safe sensing range <math>S_a</math></b>	0.648 mm
<b>Installation type</b>	Flush
<b>Switching frequency</b>	5,000 Hz
<b>Connection type</b>	Cable, 3-wire, 2 m
<b>Switching output</b>	PNP
<b>Switching output detail</b>	PNP
<b>Output function</b>	NC
<b>Electrical wiring</b>	DC 3-wire
<b>Enclosure rating</b>	IP67 <sup>1)</sup>
<b>Special features</b>	Visual adjustment indicator
<b>Items supplied</b>	Cable flag, Polymatic 50 (1 x)

<sup>1)</sup> According to EN 60529.

#### Mechanics/electronics

<b>Supply voltage</b>	10 V DC ... 30 V DC
<b>Ripple</b>	≤ 20 % <sup>1)</sup>

<sup>1)</sup> Of  $V_S$ .

<sup>2)</sup> With  $I_a = 200$  mA.

<sup>3)</sup> Supply voltage  $U_B$  and constant ambient temperature  $T_a$ .

<b>Voltage drop</b>	$\leq 2 V^{2)}$
<b>Time delay before availability</b>	$\leq 10 \text{ ms}$
<b>Hysteresis</b>	1 % ... 15 %
<b>Reproducibility</b>	$\leq 2.5 \%^{3)}$
<b>Temperature drift (of <math>S_r</math>)</b>	$\leq 10 \%$
<b>EMC</b>	EN 60947-5-2
<b>Continuous current <math>I_a</math></b>	$\leq 200 \text{ mA}$
<b>Cable material</b>	PUR
<b>Conductor size</b>	0.14 mm <sup>2</sup>
<b>Cable diameter</b>	Ø 2.9 mm
<b>Short-circuit protection</b>	✓
<b>Power-up pulse protection</b>	✓
<b>Shock and vibration resistance</b>	30 g, 11 ms / 10 ... 55 Hz, 1 mm
<b>Ambient operating temperature</b>	-25 °C ... +70 °C
<b>Housing material</b>	Stainless steel V2A, DIN 1.4305 / AISI 303
<b>Sensing face material</b>	Plastic, LCP
<b>Housing length</b>	25 mm
<b>UL File No.</b>	NRKH.E348498

1) Of  $V_S$ .

2) With  $I_a = 200 \text{ mA}$ .

3) Supply voltage  $U_B$  and constant ambient temperature  $T_a$ .

### Safety-related parameters

<b>MTTF<sub>D</sub></b>	1,350 years
<b>DC<sub>avg</sub></b>	0 %
<b>T<sub>M</sub> (mission time)</b>	20 years

### Reduction factors

<b>Note</b>	The values are reference values which may vary
<b>St37 steel (Fe)</b>	1
<b>Stainless steel (V2A, 304)</b>	Approx. 76
<b>Aluminum (Al)</b>	Approx. 0.49
<b>Copper (Cu)</b>	Approx. 0.37
<b>Brass (Br)</b>	Approx. 0.57

### Installation note

<b>Remark</b>	Associated graphic see "Installation"
<b>B</b>	0.5 mm
<b>C</b>	4 mm
<b>D</b>	2.4 mm
<b>F</b>	5 mm

### Certificates

<b>EU declaration of conformity</b>	✓
-------------------------------------	---

<b>UK declaration of conformity</b>	✓
<b>ACMA declaration of conformity</b>	✓
<b>Moroccan declaration of conformity</b>	✓
<b>China RoHS</b>	✓
<b>cULus certificate</b>	✓
<b>IO-Link certificate</b>	✓

## Classifications

<b>ECLASS 5.0</b>	27270101
<b>ECLASS 5.1.4</b>	27270101
<b>ECLASS 6.0</b>	27270101
<b>ECLASS 6.2</b>	27270101
<b>ECLASS 7.0</b>	27270101
<b>ECLASS 8.0</b>	27270101
<b>ECLASS 8.1</b>	27270101
<b>ECLASS 9.0</b>	27270101
<b>ECLASS 10.0</b>	27270101
<b>ECLASS 11.0</b>	27270101
<b>ECLASS 12.0</b>	27274001
<b>ETIM 5.0</b>	EC002714
<b>ETIM 6.0</b>	EC002714
<b>ETIM 7.0</b>	EC002714
<b>ETIM 8.0</b>	EC002714
<b>UNSPSC 16.0901</b>	39122230

## Installation note Mounting using BEF-KH-M04 bracket

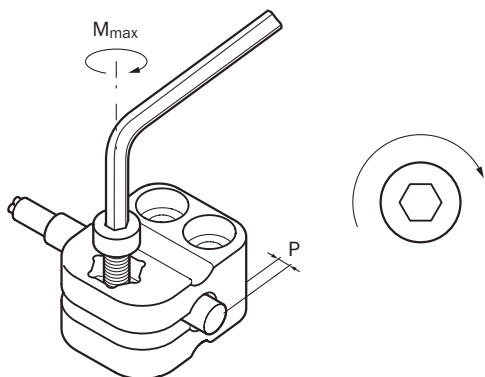

Sensor type	Mounting adapter	Overrun (P)	Max. tightening torque ( $M_{max}$ )
IHM04-0B8***** IHM04-1B5*****	BEF-KH-M04, part no. 2101065	0 mm ... 2 mm / $\geq 2$ mm	$\leq 0.4$ Nm / $\leq 0.6$ Nm

Installation note Fixing with setscrew

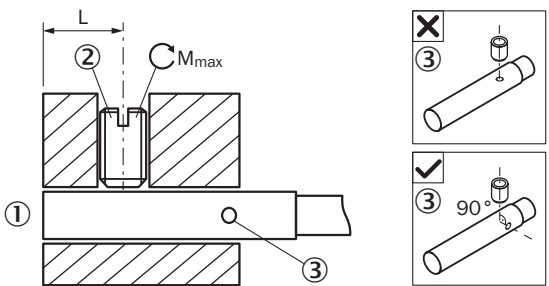

- ① Sensing face
- ② Recommended setscrew: M3, flat point
- ③ Display LED

Sensor type	Mounting area (L)	Max. tightening torque ( $M_{max}$ )
IHM04-1B5****K	5.5 mm ... 9 mm	$\leq 0.2$ Nm
IHM04-0B8****S IHM04-1B5****S	5.5 mm ... 19 mm	$\leq 0.2$ Nm
IHM04-0B8***TOS IHM04-1B5***TOS	5.5 mm ... 18 mm	$\leq 0.2$ Nm

Installation note Flush installation

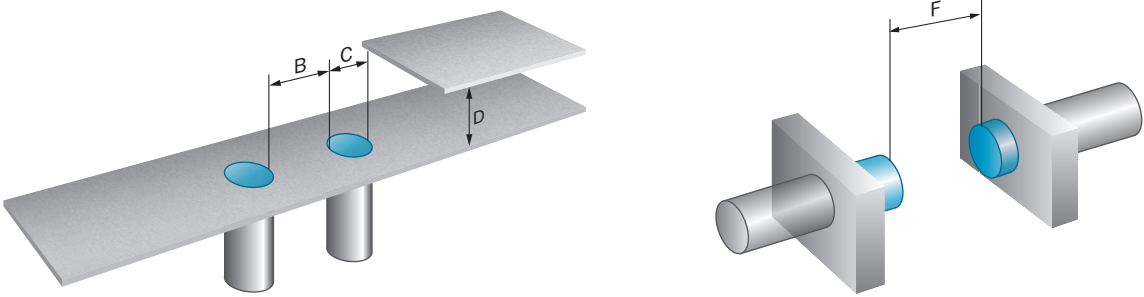

Connection diagram Cd-003

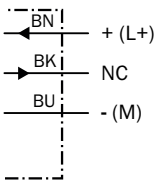

**Response diagram**

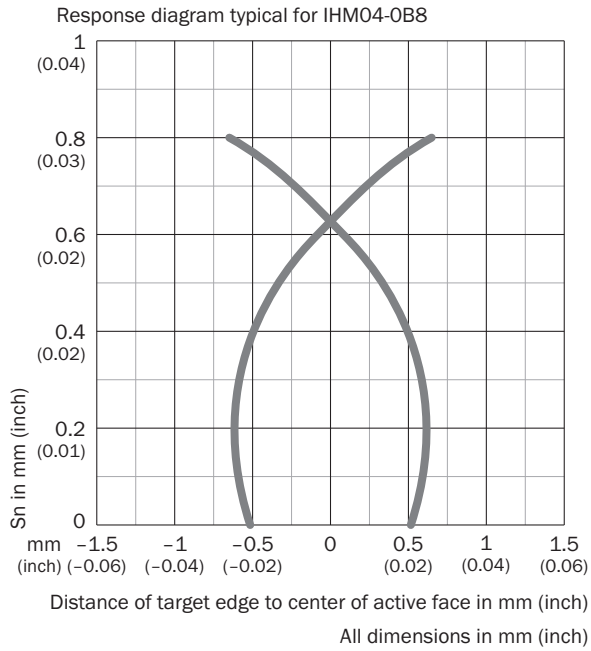

**Functional principle Installation aid**

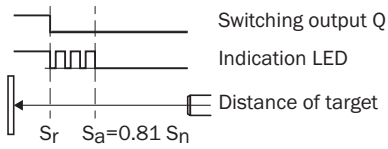



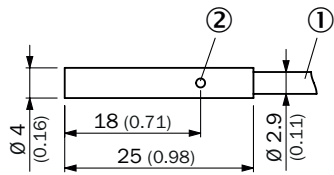



**Dimensional drawing IHM04, standard variant, flush, cable**



- Dimensions in mm (inch)  
 ① Connection  
 ② function indicator

## Recommended accessories

Other models and accessories → [www.sick.com/IMM](http://www.sick.com/IMM)

	Brief description	Type	part no.
Mounting systems			
	<ul style="list-style-type: none"> <li><b>Material:</b> Plastic</li> <li><b>Details:</b> Plastic (PA6)</li> <li><b>Items supplied:</b> Without mounting hardware</li> <li><b>Usable for:</b> Round sensors with 4 mm housing diameter without fixed stop</li> </ul>	BEF-KH-M04	2101065
connectors and cables			
	<ul style="list-style-type: none"> <li><b>Number of slots:</b> 4</li> <li><b>Slot connection type:</b> M8, 3-pin, A-coded, female connector</li> <li><b>Items supplied:</b> 5 x labeling plates</li> <li><b>Description:</b> Unshielded</li> </ul>	Y8A34A2-C2A8000XXX	2115733
	<ul style="list-style-type: none"> <li><b>Number of slots:</b> 4</li> <li><b>Slot connection type:</b> M8, 3-pin, A-coded, female connector</li> <li><b>Items supplied:</b> 5 x labeling plates</li> <li><b>Cable:</b> 5 m, 6-wire, PUR, halogen-free</li> <li><b>Description:</b> Unshielded</li> <li><b>Application:</b> Drag chain operation</li> </ul>	Y8A34A2-LXXXUAA050	2115727
	<ul style="list-style-type: none"> <li><b>Number of slots:</b> 6</li> <li><b>Slot connection type:</b> M8, 3-pin, A-coded, female connector</li> <li><b>Items supplied:</b> 5 x labeling plates</li> <li><b>Description:</b> Unshielded</li> </ul>	Y8A36A2-C2A8000XXX	2115734
	<ul style="list-style-type: none"> <li><b>Number of slots:</b> 6</li> <li><b>Slot connection type:</b> M8, 3-pin, A-coded, female connector</li> <li><b>Items supplied:</b> 5 x labeling plates</li> <li><b>Cable:</b> 5 m, 8-wire, PUR, halogen-free</li> <li><b>Description:</b> Unshielded</li> <li><b>Application:</b> Drag chain operation</li> </ul>	Y8A36A2-LXXXUBA050	2115728
	<ul style="list-style-type: none"> <li><b>Description:</b> Unshielded</li> <li><b>Connection type head A:</b> Male connector, M8, 3-pin, straight, A-coded</li> <li><b>Connection systems:</b> Screw-type terminals</li> <li><b>Permitted cross-section:</b> 0.14 mm<sup>2</sup> ... 0.5 mm<sup>2</sup></li> </ul>	STE-0803-G	6037322
	<ul style="list-style-type: none"> <li><b>Description:</b> Unshielded</li> <li><b>Connection type head A:</b> Male connector, M8, 3-pin, angled, A-coded</li> <li><b>Connection systems:</b> Screw-type terminals</li> <li><b>Permitted cross-section:</b> 0.14 mm<sup>2</sup> ... 0.5 mm<sup>2</sup></li> </ul>	STE-0803-WSK	6053170

## SICK AT A GLANCE

SICK is one of the leading manufacturers of intelligent sensors and sensor solutions for industrial applications. A unique range of products and services creates the perfect basis for controlling processes securely and efficiently, protecting individuals from accidents and preventing damage to the environment.

We have extensive experience in a wide range of industries and understand their processes and requirements. With intelligent sensors, we can deliver exactly what our customers need. In application centers in Europe, Asia and North America, system solutions are tested and optimized in accordance with customer specifications. All this makes us a reliable supplier and development partner.

Comprehensive services complete our offering: SICK LifeTime Services provide support throughout the machine life cycle and ensure safety and productivity.

For us, that is “Sensor Intelligence.”

## WORLDWIDE PRESENCE:

Contacts and other locations –[www.sick.com](http://www.sick.com)