

SICK.COM



DATA SHEET

WTB4FI-1G311120ZZZ

W4
Photoelectric sensors

SICK Sensor Intelligence

PHOTOELECTRIC SENSORS

WTB4FI-1G311120ZZZ

ORDERING INFORMATION

Type	part no.
WTB4FI-1G311120ZZZ	1113168

Further device versions and accessories at www.sick.com/W4



Illustration may differ



DETAILED TECHNICAL DATA

FEATURES

Functional principle	Photoelectric proximity sensor
Functional principle detail	Background suppression
Sensing range	
Sensing range min.	6 mm
Sensing range max.	250 mm
Adjustable switching threshold for background suppression	15 mm ... 250 mm
Reference object	Object with 90% remission factor (complies with standard white according to DIN 5033)
Minimum distance between set sensing range and background (black 6% / white 90%)	4 mm, at a distance of 100 mm
Recommended sensing range for the best performance	40 mm ... 160 mm
Emitted beam	
Light source	PinPoint LED
Type of light	Infrared light
Shape of light spot	Point-shaped
Light spot size (distance)	Ø 4.2 mm (130 mm)
Maximum dispersion of the emitted beam around the standardized transmission axis (squint angle)	< +/- 1.5° (at T ₀ = +23 °C)
Key LED figures	
Normative reference	EN 62471:2008-09 IEC 62471:2006, modified
LED risk group marking	Free group
Wave length	635 nm
Average service life	100,000 h at T _a = +25 °C
Smallest detectable object (MDO) typ.	

		0.2 mm, At 130 mm distance (object with remission factor of 90% (complies with standard white according to DIN 5033))
Adjustment	Teach-Turn adjustment	BluePilot For setting the sensing range
Display	LED blue	BluePilot: sensing range indicator
	LED green	Operating indicator Static on: power on
	LED yellow	Status of received light beam Static on: object present Static off: object not present

SAFETY-RELATED PARAMETERS

MTTF _D	642 years
DC _{avg}	0 %
T _M (mission time)	20 years

ELECTRONICS

Supply voltage U _B	10 V DC ... 30 V DC ¹⁾																				
Ripple	≤ 5 V _{pp}																				
Usage category	DC-12 (According to EN 60947-5-2) DC-13 (According to EN 60947-5-2)																				
Current consumption	≤ 25 mA, without load. At U _B = 24 V																				
Protection class	III																				
Digital output	<table border="0"> <tr> <td>Number</td> <td>1</td> </tr> <tr> <td>Type</td> <td>Push-pull: PNP/NPN</td> </tr> <tr> <td>Switching mode</td> <td>Light switching</td> </tr> <tr> <td>Signal voltage PNP HIGH/LOW</td> <td>Approx. U_B - 2.5 V / 0 V</td> </tr> <tr> <td>Signal voltage NPN HIGH/LOW</td> <td>Approx. U_B / < 2.5 V</td> </tr> <tr> <td>Output current I_{max}</td> <td>≤ 100 mA</td> </tr> <tr> <td>Circuit protection outputs</td> <td>Reverse polarity protected Overcurrent protected Short-circuit protected</td> </tr> <tr> <td>Response time</td> <td>≤ 500 μs</td> </tr> <tr> <td>Repeatability (response time)</td> <td>150 μs²⁾</td> </tr> <tr> <td>Switching frequency</td> <td>1,000 Hz³⁾</td> </tr> </table>	Number	1	Type	Push-pull: PNP/NPN	Switching mode	Light switching	Signal voltage PNP HIGH/LOW	Approx. U _B - 2.5 V / 0 V	Signal voltage NPN HIGH/LOW	Approx. U _B / < 2.5 V	Output current I _{max}	≤ 100 mA	Circuit protection outputs	Reverse polarity protected Overcurrent protected Short-circuit protected	Response time	≤ 500 μs	Repeatability (response time)	150 μs ²⁾	Switching frequency	1,000 Hz ³⁾
Number	1																				
Type	Push-pull: PNP/NPN																				
Switching mode	Light switching																				
Signal voltage PNP HIGH/LOW	Approx. U _B - 2.5 V / 0 V																				
Signal voltage NPN HIGH/LOW	Approx. U _B / < 2.5 V																				
Output current I _{max}	≤ 100 mA																				
Circuit protection outputs	Reverse polarity protected Overcurrent protected Short-circuit protected																				
Response time	≤ 500 μs																				
Repeatability (response time)	150 μs ²⁾																				
Switching frequency	1,000 Hz ³⁾																				
Pin/Wire assignment	<table border="0"> <tr> <td>Function of pin 4/black (BK)</td> <td>Digital output, light switching, object present → output Q HIGH⁴⁾</td> </tr> </table>	Function of pin 4/black (BK)	Digital output, light switching, object present → output Q HIGH ⁴⁾																		
Function of pin 4/black (BK)	Digital output, light switching, object present → output Q HIGH ⁴⁾																				

¹⁾ Limit values.

²⁾ Signal transit time with resistive load in switching mode.

³⁾ With light/dark ratio 1:1.

⁴⁾ This switching output must not be connected to another output.

MECHANICS

Housing	Rectangular
Design detail	Flat
Dimensions (W x H x D)	16 mm x 40.1 mm x 12.1 mm

Connection	Cable, 3-wire, 2 m	
Connection detail	Deep-freeze property	Do not bend below 0 °C
	Conductor size	0.14 mm ²
	Cable diameter	Ø 3.4 mm
	Length of cable (L)	2 m
Material	Housing	Plastic, VISTAL®
	Front screen	Plastic, PMMA
	Cable	Plastic, PVC
Weight	Approx. 30 g	
Maximum tightening torque of the fixing screws	0.4 Nm	

AMBIENT DATA

Enclosure rating	IP66 (EN 60529) IP67 (EN 60529)
Ambient operating temperature	-40 °C ... +60 °C
Ambient temperature, storage	-40 °C ... +75 °C
Typ. Ambient light immunity	Artificial light: ≤ 50,000 lx Sunlight: ≤ 50,000 lx
Shock resistance	30 g, 11 ms (3 positive and 3 negative shocks along X, Y, Z axes, 18 total shocks (EN60068-2-27))
Vibration resistance	10 Hz ... 1,000 Hz (Amplitude 1 mm, 3 x 30 min (EN60068-2-6))
Air humidity	35 % ... 95 %, relative humidity (no condensation)
Electromagnetic compatibility (EMC)	EN 60947-5-2
Resistance to cleaning agent	ECOLAB
UL File No.	NRKH.E181493 & NRKH7.E181493

CERTIFICATES

EU declaration of conformity	✓
UK declaration of conformity	✓
ACMA declaration of conformity	✓
Moroccan declaration of conformity	✓
China RoHS	✓
ECOLAB certificate	✓
cULus certificate	✓

DISPLAY AND ADJUSTMENT ELEMENTS

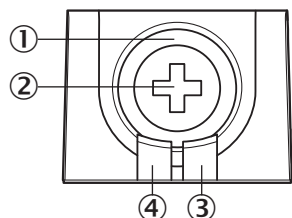

- ① LED blue
- ② Teach-Turn adjustment
- ③ LED yellow
- ④ LED green

CONNECTION TYPE CABLE, 3-WIRE

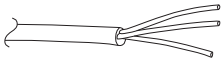

CONNECTION DIAGRAM CD-043

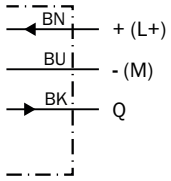

TRUTH TABLE PUSH-PULL: PNP/NPN - LIGHT SWITCHING Q

	Light switching Q (normally open (upper switch), normally closed (lower switch))	
	Object not present → Output LOW	Object present → Output HIGH
Light receive	✘	✔
Light receive indicator	✘	☀
Load resistance to L+	⚡	✘
Load resistance to M	✘	⚡

TRUTH TABLE PUSH-PULL: PNP/NPN - DARK SWITCHING \bar{Q}

	Dark switching \bar{Q} (normally closed (upper switch), normally open (lower switch))	
	Object not present → Output HIGH	Object present → Output LOW
Light receive	⊗	✓
Light receive indicator	⊗	☀
Load resistance to L+	⊗	⚡
Load resistance to M	⚡	⊗

CHARACTERISTIC CURVE

Minimum distance in mm (y) between the set sensing range and white background (90 % remission)

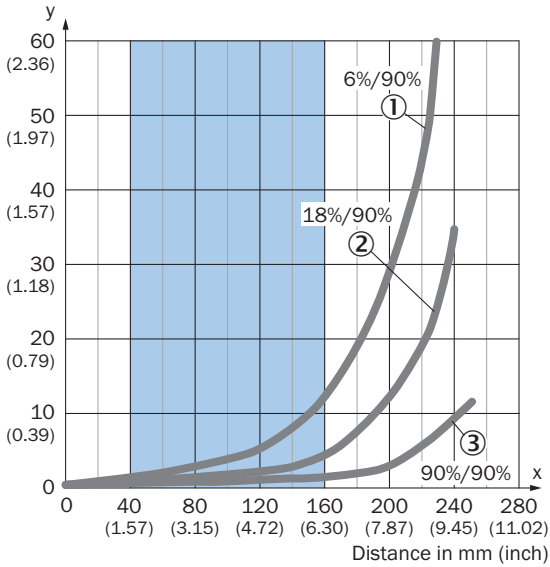

Example:
Safe suppression of the background

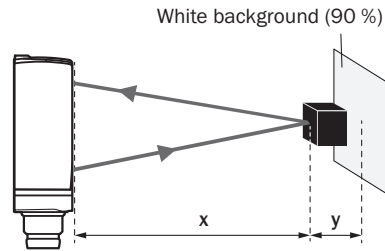

Black object (6 % remission)
Set sensing range $x = 200$ mm
Needed minimum distance to white background $y = 29$ mm

Recommended sensing range for the best performance

- ① Black object, 6% remission factor
- ② Gray object, 18% remission factor
- ③ White object, 90% remission factor

LIGHT SPOT SIZE

Dimensions in mm (inch)

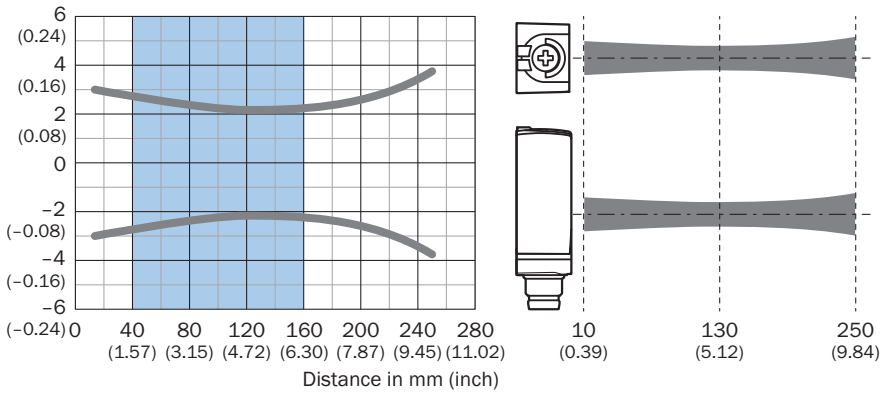

Recommended sensing range for the best performance

SENSING RANGE DIAGRAM

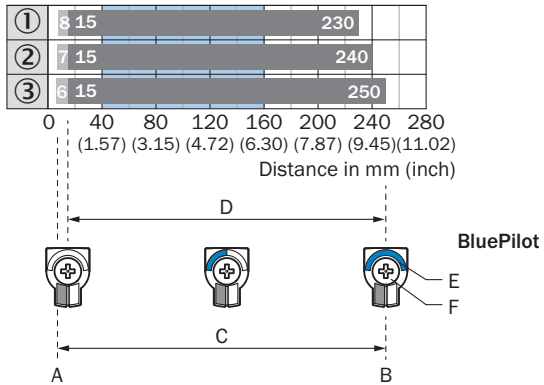

- A = Sensing range min. in mm
- B = Sensing range max. in mm
- C = Viewing range
- D = Adjustable switching threshold for background suppression
- E = Sensing range indicator
- F = Teach-Turn adjustment

Recommended sensing range for the best performance

- ① Black object, 6% remission factor
- ② Gray object, 18% remission factor
- ③ White object, 90% remission factor

DIMENSIONAL DRAWING

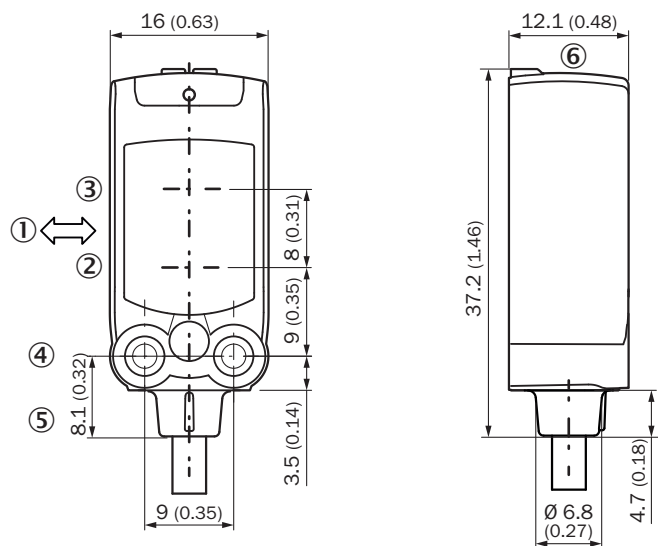

Dimensions in mm (inch)

- ① Standard direction of the material being detected
- ② Center of optical axis, sender
- ③ Center of optical axis, receiver
- ④ M3 mounting hole
- ⑤ Connection
- ⑥ display and adjustment elements

Further information as well as suitable accessories, example applications and downloads such as CAD dimensional models, operating instructions and software can be found at www.sick.com/1113168



SICK AG
WALDKIRCH
GERMANY
SICK.COM

SICK AT A GLANCE

SICK is a leading global technology company for intelligent sensors and integrated solutions in industrial automation. Our technologies set benchmarks, making your industrial processes more efficient, safer and more sustainable – both in logistics and manufacturing operations.

SICK combines sensor intelligence with industry expertise and certified consulting services. We provide the ideal foundation for scalable as well as tailor-made automation solutions and create added value along the entire value chain. Our close partnerships with our customers are more than just a promise: Together, we optimize productivity, improve quality, protect health and safety, and help build a sustainable future. All with empathy and trust.

Since 1946, we have been developing innovative technologies with passion and a pioneering spirit. With a global network in around 40 countries, SICK has a global presence and is always close by. The company's headquarters are located in Waldkirch near Freiburg, Germany. Our customers benefit from our understanding of both local and global requirements, which enables us to deliver tailor-made solutions

SICK
Sensor Intelligence