

# AHS36I-BDAC004096

AHS/AHM36

**ABSOLUTE ENCODERS**

**SICK**  
Sensor Intelligence.

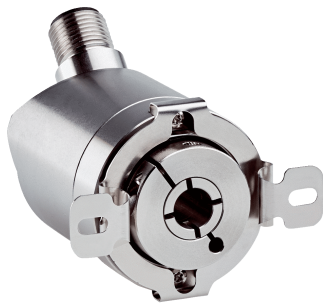

Illustration may differ



### Ordering information

Type	part no.
AHS36I-BDAC004096	1113118

Other models and accessories → [www.sick.com/AHS\\_AHM36](http://www.sick.com/AHS_AHM36)

### Detailed technical data

#### Safety-related parameters

<b>MTTF<sub>D</sub> (mean time to dangerous failure)</b>	230 years (EN ISO 13849-1) <sup>1)</sup>
--	--

<sup>1)</sup> This product is a standard product and does not constitute a safety component as defined in the Machinery Directive. Calculation based on nominal load of components, average ambient temperature 40 °C, frequency of use 8760 h/a. All electronic failures are considered hazardous. For more information, see document no. 8015532.

#### Performance

<b>Number of steps per revolution (max. resolution)</b>	4,096 (12 bit)
<b>Error limits G</b>	0.35° (at 20 °C) <sup>1)</sup>
<b>Repeatability standard deviation <math>\sigma_r</math></b>	0.2° (at 20 °C) <sup>2)</sup>

<sup>1)</sup> In accordance with DIN ISO 1319-1, position of the upper and lower error limit depends on the installation situation, specified value refers to a symmetrical position, i.e. deviation in upper and lower direction is the same.

<sup>2)</sup> In accordance with DIN ISO 55350-13; 68.3% of the measured values are inside the specified area.

#### Interfaces

<b>Communication interface</b>	SSI
<b>Initialization time</b>	100 ms <sup>1)</sup>
<b>Position forming time</b>	125 µs
<b>Process data</b>	Position
<b>Code type</b>	Gray
<b>Code sequence parameter adjustable</b>	CW/CCW (V/R) configurable via cable
<b>Clock frequency</b>	2 MHz <sup>2)</sup>
<b>Set (electronic adjustment)</b>	H-active (L = 0 - 3 V, H = 4,0 - U <sub>s</sub> V)
<b>CW/CCW (counting sequence when turning)</b>	L-active (L = 0 - 1 V, H = 2,0 - U <sub>s</sub> V)

<sup>1)</sup> Valid positional data can be read once this time has elapsed.

<sup>2)</sup> Minimum, LOW level (Clock +): 250 ns.

## Electronics

<b>Connection type</b>	Male connector, M12, 8-pin, universal
<b>Supply voltage</b>	4.5 ... 32 V DC
<b>Power consumption</b>	≤ 1.5 W (without load)
<b>Reverse polarity protection</b>	✓

## Mechanics

<b>Mechanical design</b>	Blind hollow shaft
<b>Shaft diameter</b>	10 mm
<b>Characteristics of the shaft</b>	Front clamp
<b>Weight</b>	0.2 kg <sup>1)</sup>
<b>Shaft material</b>	Stainless steel 1,4305
<b>Flange material</b>	Stainless steel 1,4305
<b>Material, stator coupling</b>	Stainless steel 1,4305
<b>Housing material</b>	Stainless steel 1,4305
<b>Start up torque</b>	1 Ncm (+20 °C)
<b>Operating torque</b>	< 1 Ncm (+20 °C)
<b>Permissible movement static</b>	± 0.3 mm, ± 0.3 mm (radial, axial)
<b>Permissible movement dynamic</b>	± 0.1 mm (radial) ± 0.1 mm (axial)
<b>Operating speed</b>	≤ 6,000 min <sup>-1</sup> 2)
<b>Moment of inertia of the rotor</b>	23 gcm <sup>2</sup>
<b>Bearing lifetime</b>	2.0 x 10 <sup>9</sup> revolutions
<b>Angular acceleration</b>	≤ 500,000 rad/s <sup>2</sup>

<sup>1)</sup> Based on devices with male connector.

<sup>2)</sup> Allow for self-heating of 3.5 K per 1,000 rpm when designing the operating temperature range.

## Ambient data

<b>EMC</b>	According to EN 61000-6-2 and EN 61000-6-3
<b>Enclosure rating</b>	IP67 (IEC 60529) IP69K (IEC 60529)
<b>Permissible relative humidity</b>	90 % (Condensation not permitted)
<b>Operating temperature range</b>	-40 °C ... +100 °C
<b>Storage temperature range</b>	-40 °C ... +100 °C, without package
<b>Resistance to shocks</b>	100 g, 6 ms (EN 60068-2-27)
<b>Resistance to vibration</b>	20 g, 10 Hz ... 2,000 Hz (EN 60068-2-6) <sup>1)</sup>

<sup>1)</sup> For side-mounted encoders (horizontal encoder shaft, vertical stator coupling), additional damping measures may be required in some cases as resonances can arise. Furthermore, the cable must be fastened with the shortest possible distance to the encoder.

## Certificates

<b>EU declaration of conformity</b>	✓
<b>UK declaration of conformity</b>	✓
<b>ACMA declaration of conformity</b>	✓
<b>Moroccan declaration of conformity</b>	✓

China RoHS	✓
cTUVus certificate	✓
Information according to Art. 3 of Data Act (Regulation EU 2023/2854)	✓

### Classifications

<b>ECLASS 5.0</b>	27270502
<b>ECLASS 5.1.4</b>	27270502
<b>ECLASS 6.0</b>	27270590
<b>ECLASS 6.2</b>	27270590
<b>ECLASS 7.0</b>	27270502
<b>ECLASS 8.0</b>	27270502
<b>ECLASS 8.1</b>	27270502
<b>ECLASS 9.0</b>	27270502
<b>ECLASS 10.0</b>	27270502
<b>ECLASS 11.0</b>	27270502
<b>ECLASS 12.0</b>	27270502
<b>ETIM 5.0</b>	EC001486
<b>ETIM 6.0</b>	EC001486
<b>ETIM 7.0</b>	EC001486
<b>ETIM 8.0</b>	EC001486
<b>UNSPSC 16.0901</b>	41112113

### Dimensional drawing Blind hollow shaft, male connector

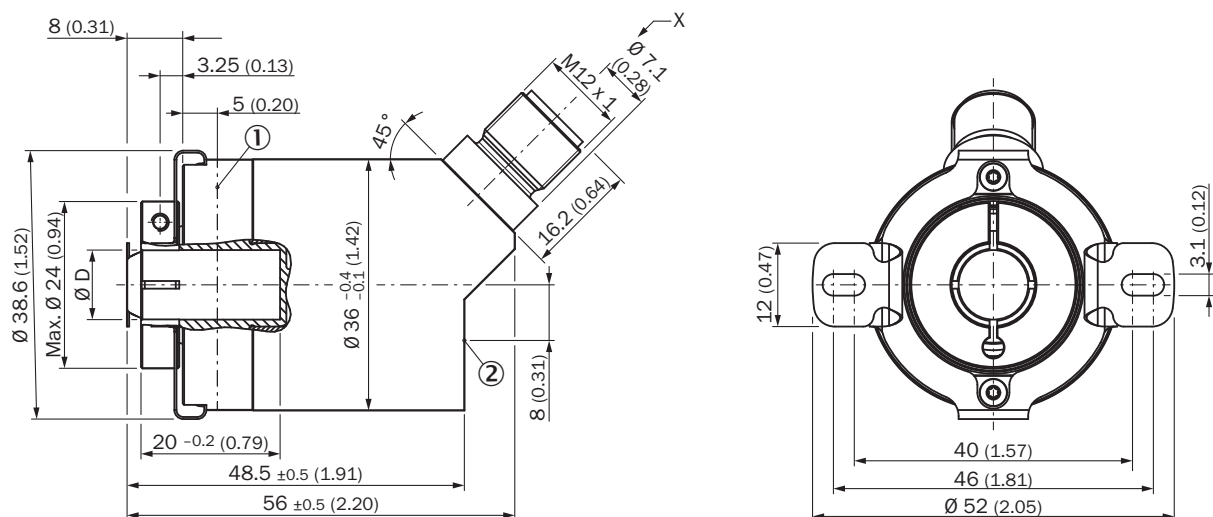

Dimensions in mm (inch)

Non-tolerated dimensions according to DIN-ISO 2768-mk

① Measuring point for operating temperature

② measuring point for vibrations

Type	Shaft diameter $\varnothing$ D F7
AHx36x-BAxxxxxxx	6 mm
AHx36x-BBxxxxxxx	8 mm
AHx36x-BCxxxxxxx	1/4"
AHx36x-BDxxxxxxx	10 mm
AHx36x-BKxxxxxxx	3/8"

Attachment specifications

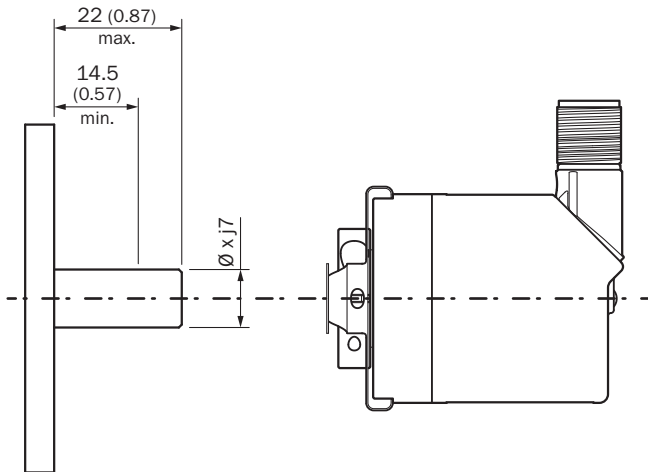

Anschlussbelegung M12 male connector, 8-pin and cable, 8-wire, SSI/Gray

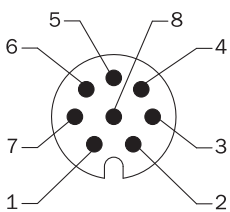







view of M12 male device connector on encoder

PIN	Wire colors (cable connection)	Signal	Explanation
1	Brown	Data -	Interface signals
2	White	Data +	Interface signals
3	Black	V/R	Sequence in direction of rotation
4	Pink	SET	Electronic adjustment-Interface signals
5	Yellow	Clock +	Interface signals
6	Purple	Clock -	Interface signals
7	Blue	GND	Ground connection
8	Red	U <sub>S</sub>	Operating voltage
-	-	Shielding	Shielding connected to housing on encoder side. Connected to ground on control side.

### Recommended accessories

Other models and accessories → [www.sick.com/AHS\\_AHM36](http://www.sick.com/AHS_AHM36)

	Brief description	Type	part no.
connectors and cables			
	<ul style="list-style-type: none"> <li><b>Description:</b> Shielded</li> <li><b>Connection type head A:</b> Female connector, M12, 8-pin, straight, A-coded</li> <li><b>Connection systems:</b> Screw-type terminals</li> <li><b>Permitted cross-section:</b> 0.25 mm<sup>2</sup> ... 0.5 mm<sup>2</sup></li> <li><b>Application:</b> Hygienic and washdown zones</li> </ul>	YF12ES8-0050S5586A	2097334
	<ul style="list-style-type: none"> <li><b>Description:</b> Shielded</li> <li><b>Connection type head A:</b> Male connector, M12, 8-pin, straight, A-coded</li> <li><b>Connection systems:</b> Screw-type terminals</li> <li><b>Permitted cross-section:</b> ≤ 0.5 mm<sup>2</sup></li> <li><b>Application:</b> Hygienic and washdown zones</li> </ul>	YM12ES8-0050S5586A	2097337
	<ul style="list-style-type: none"> <li><b>Description:</b> Incremental, shielded, SSI</li> <li><b>Connection type head A:</b> Female connector, M12, 8-pin, straight</li> <li><b>Connection type head B:</b> Flying leads</li> <li><b>Signal type:</b> Incremental, SSI</li> <li><b>Cable:</b> 2 m, 8-wire, PUR, halogen-free</li> <li><b>Connection systems:</b> Flying leads</li> <li><b>Application:</b> Drag chain operation, Zones with oils and lubricants</li> </ul>	DOL-1208-G02MAC1	6032866
	<ul style="list-style-type: none"> <li><b>Description:</b> Incremental, shielded, SSI</li> <li><b>Connection type head A:</b> Female connector, M12, 8-pin, straight</li> <li><b>Connection type head B:</b> Flying leads</li> <li><b>Signal type:</b> Incremental, SSI</li> <li><b>Cable:</b> 5 m, 8-wire, PUR, halogen-free</li> <li><b>Connection systems:</b> Flying leads</li> <li><b>Application:</b> Drag chain operation, Zones with oils and lubricants</li> </ul>	DOL-1208-G05MAC1	6032867
	<ul style="list-style-type: none"> <li><b>Description:</b> Incremental, shielded, SSI</li> <li><b>Connection type head A:</b> Female connector, M12, 8-pin, straight</li> <li><b>Connection type head B:</b> Flying leads</li> <li><b>Signal type:</b> Incremental, SSI</li> <li><b>Cable:</b> 10 m, 8-wire, PUR, halogen-free</li> <li><b>Connection systems:</b> Flying leads</li> <li><b>Application:</b> Drag chain operation, Zones with oils and lubricants</li> </ul>	DOL-1208-G10MAC1	6032868
	<ul style="list-style-type: none"> <li><b>Description:</b> Incremental, shielded, SSI</li> <li><b>Connection type head A:</b> Female connector, M12, 8-pin, straight</li> <li><b>Connection type head B:</b> Flying leads</li> <li><b>Signal type:</b> Incremental, SSI</li> <li><b>Cable:</b> 20 m, 8-wire, PUR, halogen-free</li> <li><b>Connection systems:</b> Flying leads</li> <li><b>Application:</b> Drag chain operation, Zones with oils and lubricants</li> </ul>	DOL-1208-G20MAC1	6032869
Mounting systems			
	<ul style="list-style-type: none"> <li><b>Product family:</b> Stator couplings</li> <li><b>Description:</b> Standard stator coupling, AHS/AHM36</li> </ul>	BEF-DS16-AHX	2108615

## SICK AT A GLANCE

SICK is one of the leading manufacturers of intelligent sensors and sensor solutions for industrial applications. A unique range of products and services creates the perfect basis for controlling processes securely and efficiently, protecting individuals from accidents and preventing damage to the environment.

We have extensive experience in a wide range of industries and understand their processes and requirements. With intelligent sensors, we can deliver exactly what our customers need. In application centers in Europe, Asia and North America, system solutions are tested and optimized in accordance with customer specifications. All this makes us a reliable supplier and development partner.

Comprehensive services complete our offering: SICK LifeTime Services provide support throughout the machine life cycle and ensure safety and productivity.

For us, that is “Sensor Intelligence.”

## WORLDWIDE PRESENCE:

Contacts and other locations –[www.sick.com](http://www.sick.com)