



OLS20-BB1114342

OLS

CONTRAST SENSORS

SICK
Sensor Intelligence.



Illustration may differ

Ordering information

Type	part no.
OLS20-BB114342	1113053

Other models and accessories → www.sick.com/OLS



Detailed technical data

Features

Housing design	Middle
Dimensions (W x H x D)	31 mm x 62 mm x 52.5 mm
Module width (min.)	≥ 1.5 mm
Line radius (min.)	≥ 0.5 m
Track color	Orange
Light source	LED, visible blue light ¹⁾
Light spot size	180 mm x 9 mm ²⁾
Receiving filters	≤ 610 nm
Wave length	450 nm
Bar code types	2/5 Interleaved with checksum
Working range	90 mm ... 110 mm
Sensing distance	≤ 100 mm
Sensing distance tolerance	± 10 mm
Safety-related parameters	
	MTTF _D 271 years

¹⁾ Average service life: 100,000 h at T_U = +25 °C.

²⁾ Field of view line +90mm, field of view code +50mm.

Interfaces

IO-Link	✓ , COM3 (230,4 kBaud)
Cycle time	5 ms
Process data length	21 Byte Process Data In
CANopen	✓
Digital output	Q ₁
Number	1

Electronics

Supply voltage	18 V DC ... 30 V DC ¹⁾
Ripple	≤ 5 V _{pp} ²⁾
Power consumption	< 3 W ³⁾
Sampling rate	5 ms
Accuracy optical center	± 1 mm
Switching output	Push-pull: PNP/NPN
Switching output (voltage)	Push-pull: PNP/NPN HIGH = U _V - 3 V/LOW ≤ 3 V
Output current I_{max.}	< 100 mA
Time delay	None
Protection class	III
Circuit protection	U _V connections, reverse polarity protected Output Q short-circuit protected Interference pulse suppression
LED risk group	2 (IEC 62471)
Connection type	Plug, M12, 5-pin

¹⁾ Limit values when operated in short-circuit protected network: max. 8 A.

²⁾ May not fall below or exceed U_V tolerances.

³⁾ Without load.

Mechanics

Housing material	Zinc diecast
Weight	250 g

Ambient data

Ambient operating temperature	-10 °C ... +55 °C
Ambient temperature, storage	-25 °C ... +75 °C
Ambient light immunity	50,000 lx
Shock load	According to IEC 60068
Enclosure rating	IP67
UL File No.	NRKH.E181493 & NRKH7.E181493

Certificates

EU declaration of conformity	✓
UK declaration of conformity	✓
ACMA declaration of conformity	✓

Moroccan declaration of conformity	✓
China RoHS	✓
cULus certificate	✓
IO-Link certificate	✓
CANopen certificate	✓
Photobiological safety (IEC EN 62471)	✓
Information according to Art. 3 of Data Act (Regulation EU 2023/2854)	✓

Classifications

ECLASS 5.0	27270906
ECLASS 5.1.4	27270906
ECLASS 6.0	27270906
ECLASS 6.2	27270906
ECLASS 7.0	27270906
ECLASS 8.0	27270906
ECLASS 8.1	27270906
ECLASS 9.0	27270906
ECLASS 10.0	27270906
ECLASS 11.0	27270906
ECLASS 12.0	27270906
ETIM 5.0	EC001820
ETIM 6.0	EC001820
ETIM 7.0	EC001820
ETIM 8.0	EC001820
UNSPSC 16.0901	39121528

Dimensional drawing

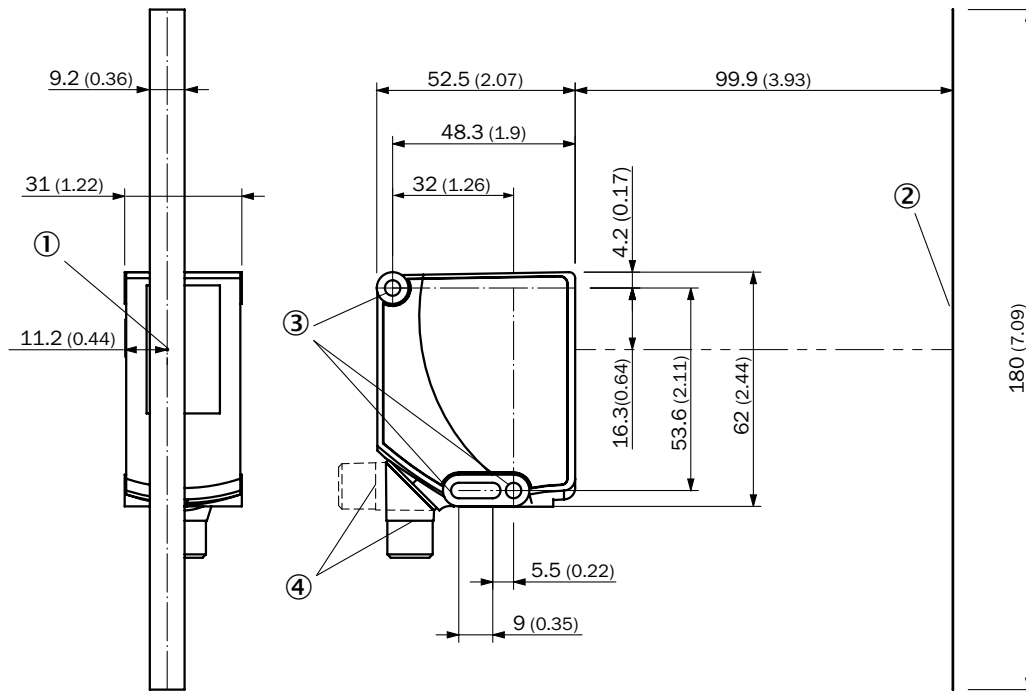

Dimensions in mm (inch)

- ① Optical axis
- ② Field of view
- ③ Mounting hole, \varnothing 4.1 mm
- ④ Connector M12 (rotatable up to 180°)

Adjustments

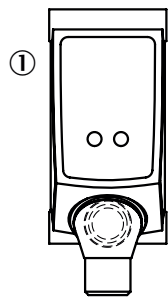



- ① Indicator lamps

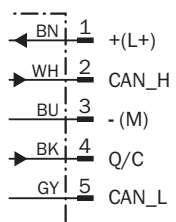



Connection diagram Cd-422



Recommended accessories

Other models and accessories → www.sick.com/OLS

	Brief description	Type	part no.
Codes			
	<ul style="list-style-type: none"> Description: 1D bar codes in 2/5 interleaved format with 3 digits plus checksum, set of 108 bar codes, 12 A4 sheets of 9 bar codes each, luminescent PVC base material with protective film, codes 0001 ... 0108, neon orange 	BARCODE 7510-038-0001-0108-N	5343612
	<ul style="list-style-type: none"> Description: 1D bar codes in 2/5 interleaved format with 3 digits plus checksum, set of 108 bar codes, 12 A4 sheets of 9 bar codes each, luminescent PVC base material with protective film, codes 0109 ... 0216, neon orange 	BARCODE 7510-038-0109-0216-N	5343613
	<ul style="list-style-type: none"> Description: 1D bar codes in 2/5 interleaved format, set of 108 bar codes, 9 A4 sheets of 12 bar codes each, luminescent PVC base material with protective film, codes 0001 ... 0108, neon orange 	BARCODE 7510-038-0001-0108	5338408
	<ul style="list-style-type: none"> Description: Luminescent duct tape for easy application to all types of flooring, width 2.5 cm, length 25 m, neon orange 	ADHESIVE TAPE, FABRIC	5337868
	<ul style="list-style-type: none"> Description: Luminescent rugged PVC adhesive tape for easy application to all types of flooring, width 2 cm, length 25 m, neon orange 	TAPE 7510-038-20-25	5338378
	<ul style="list-style-type: none"> Description: Scope of delivery: 1 x 90° arc: luminescent rugged PVC adhesive tape, prepared as 90° arc with a radius of 500 mm, neon orange 	TAPE 7510-038-500	5338387
	<ul style="list-style-type: none"> Description: Scope of delivery: 1 x 90° arc: luminescent rugged PVC adhesive tape, prepared as 90° arc with a radius of 1,000 mm, neon orange 	TAPE 7510-038-1000	5338388
	<ul style="list-style-type: none"> Description: Protective film for adhesive tape, slip resistance class R10, protection against abrasion and moisture, width 3,5 cm, length 50 m 	TAPE 250AS-35-50	5338386
	<ul style="list-style-type: none"> Description: Scope of delivery: 1 x 90° arc, protective film for adhesive tape, slip resistance class R10, protection against abrasion and moisture, prepared as 90° arc with a radius of 500 mm 	TAPE 250AS-500-35	5338389
	<ul style="list-style-type: none"> Description: Scope of delivery: 1 x 90° arc, protective film for adhesive tape, slip resistance class R10, protection against abrasion and moisture, prepared as 90° arc with a radius of 1,000 mm 	TAPE 250AS-100-35	5338390
	<ul style="list-style-type: none"> Description: 1D barcodes in 2/5 interleaved format, set of 108 barcodes, 9 A4 sheets of 12 barcodes each, luminescent PVC base material with protective film, codes 0109 ... 0218, neon orange. Supplement (subsequent codes) for https://www.sick.com/5338408 target="_blank">BARCODE 7510-038-0001-0108. 	BARCODE 7510-038-0109-0218	5342395

	Brief description	Type	part no.
connectors and cables			
	<ul style="list-style-type: none"> • Description: Unshielded • Connection type head A: Male connector, M12, 5-pin, straight, A-coded • Connection systems: Screw-type terminals • Permitted cross-section: ≤ 0.75 mm² • Note: For field bus technology 	STE-1205-G	6022083
	<ul style="list-style-type: none"> • Description: Sensor/actuator cable, unshielded • Connection type head A: Female connector, M12, 5-pin, straight, A-coded • Connection type head B: Flying leads • Signal type: Sensor/actuator cable • Cable: 5 m, 5-wire, PVC • Application: Uncontaminated zones, Zones with chemicals 	YF2A15-050VB5XLEAX	2096240
Mounting systems			
	<ul style="list-style-type: none"> • Description: Plate N04 for universal clamp, steel • Material: Steel, zinc diecast • Details: Zinc plated steel (sheet), Zinc die cast (clamping bracket) • Items supplied: Universal clamp (5322626), mounting hardware • Usable for: Dx50, UC12, W12G, W14-2, W18-2, W23, W280, W11-2, W12-3, W12-2 Laser, W12 Teflon, W16, W18-3, W23-2, W24-2, W24-2 Ex, W26, W27-2 Laser, W27-2, W27-3, W34, W260, W280-2, PowerProx, Reflex Array, W11G-2, W18-3 Ex, W27-3 Ex 	BEF-KHS-N04	2051610
network devices			
		IOLA2US-01101 (SiLink2 Master)	1061790

SICK AT A GLANCE

SICK is one of the leading manufacturers of intelligent sensors and sensor solutions for industrial applications. A unique range of products and services creates the perfect basis for controlling processes securely and efficiently, protecting individuals from accidents and preventing damage to the environment.

We have extensive experience in a wide range of industries and understand their processes and requirements. With intelligent sensors, we can deliver exactly what our customers need. In application centers in Europe, Asia and North America, system solutions are tested and optimized in accordance with customer specifications. All this makes us a reliable supplier and development partner.

Comprehensive services complete our offering: SICK LifeTime Services provide support throughout the machine life cycle and ensure safety and productivity.

For us, that is “Sensor Intelligence.”

WORLDWIDE PRESENCE:

Contacts and other locations –www.sick.com