



# DBS60E-REAZGS329

DBS60

INCREMENTAL ENCODERS

**SICK**  
Sensor Intelligence.



Illustration may differ



### Ordering information

Type	part no.
DBS60E-REAZGS329	1112070

Other models and accessories → [www.sick.com/DBS60](http://www.sick.com/DBS60)

### Detailed technical data

#### Features

<b>Special device</b>	✓
<b>Specialty</b>	8-wire PUR cable, universal, 1.5 m, open cable end with ESD bag at the cable end, customer-specific wire colors, enclosure rating IP66, customer-specific encoder label with Getriebbau NORD part number: 19651802 Second and identical encoder label fastened to packaging, customer-specific packaging label, no operating instructions (can be accessed digitally), device is exclusively for GBN
<b>Standard reference device</b>	DBS60E-RHCKG4096
<b>Additional information</b>	Getriebbau NORD part number: 19651802

#### Safety-related parameters

<b>MTTF<sub>D</sub> (mean time to dangerous failure)</b>	500 years (EN ISO 13849-1) <sup>1)</sup>
--	--

<sup>1)</sup> This product is a standard product and does not constitute a safety component as defined in the Machinery Directive. Calculation based on nominal load of components, average ambient temperature 40 °C, frequency of use 8760 h/a. All electronic failures are considered hazardous. For more information, see document no. 8015532.

#### Performance

<b>Pulses per revolution</b>	4,096
<b>Measuring step</b>	≤ 90 °, electric/pulses per revolution
<b>Measuring step deviation</b>	± 36 ° / pulses per revolution
<b>Error limits</b>	Measuring step deviation x 3
<b>Duty cycle</b>	≤ 0.5 ± 10 %

#### Interfaces

<b>Communication interface</b>	Incremental
<b>Communication Interface detail</b>	TTL / RS-422
<b>Number of signal channels</b>	6-channel
<b>Initialization time</b>	< 5 ms <sup>1)</sup>
<b>Output frequency</b>	+ 300 kHz <sup>2)</sup>
<b>Load current</b>	≤ 30 mA, per channel

<sup>1)</sup> Valid signals can be read once this time has elapsed.

<sup>2)</sup> Up to 450 kHz on request.

<b>Power consumption</b>	≤ 0.5 W (without load)
--------------------------	------------------------

1) Valid signals can be read once this time has elapsed.

2) Up to 450 kHz on request.

## Electronics

<b>Connection type</b>	Special version
<b>Connection type Detail</b>	8-wire PUR cable, universal, 1.5 m, open cable end with ESD bag at the cable end, customer-specific wire colors, enclosure rating IP66, customer-specific encoder label with Getriebebau NORD part number: 19651802
<b>Supply voltage</b>	4.5 ... 5.5 V
<b>Reference signal, number</b>	1
<b>Reference signal, position</b>	90°, electric, logically gated with A and B
<b>Reverse polarity protection</b>	✓
<b>Short-circuit protection of the outputs</b>	✓ <sup>1)</sup>

1) Short-circuit opposite to another channel or GND permissible for max. 60 s. No protection signal against  $U_S$ .

## Mechanics

<b>Mechanical design</b>	Through hollow shaft
<b>Shaft diameter</b>	12 mm Rear clamping
<b>Flange type / stator coupling</b>	1-sided stator coupling, slot, screw hole circle radius 32.1 mm–37.6 mm
<b>Weight</b>	+ 0.25 kg <sup>1)</sup>
<b>Shaft material</b>	Stainless steel
<b>Flange material</b>	Aluminum
<b>Housing material</b>	Aluminum
<b>Material, cable</b>	PUR
<b>Start up torque</b>	+ 2.6 Ncm (+20 °C)
<b>Operating torque</b>	2.5 Ncm (+20 °C)
<b>Permissible movement static</b>	± 0.3 mm (radial) ± 0.5 mm (axial) <sup>2)</sup>
<b>Permissible movement dynamic</b>	± 0.1 mm (radial) ± 0.2 mm (axial) <sup>2)</sup>
<b>Operating speed</b>	6,000 min <sup>-1</sup> <sup>3)</sup>
<b>Maximum operating speed</b>	9,000 min <sup>-1</sup> <sup>4)</sup>
<b>Moment of inertia of the rotor</b>	50 gcm <sup>2</sup>
<b>Bearing lifetime</b>	3.6 x 10 <sup>9</sup> revolutions
<b>Angular acceleration</b>	≤ 500,000 rad/s <sup>2</sup>

1) Based on encoder with male connector or cable with male connector.

2) Not applicable for stator coupling type C and K.

3) Allow for self-heating of 2.6 K per 1,000 rpm when designing the operating temperature range.

4) Maximum speed which does not cause mechanical damage to the encoder. Impact on the service life and signal quality is possible. Please note the maximum output frequency.

### Ambient data

<b>EMC</b>	According to EN 61000-6-2 and EN 61000-6-3
<b>Enclosure rating</b>	IP66, housing side (IEC 60529) <sup>1)</sup> IP66, shaft side (IEC 60529)
<b>Permissible relative humidity</b>	90 % (Condensation not permitted)
<b>Operating temperature range</b>	-25 °C ... +80 °C, at maximum 3,000 pulses per revolution <sup>2)</sup>
<b>Storage temperature range</b>	-40 °C ... +100 °C, without package
<b>Resistance to shocks</b>	250 g, 3 ms (EN 60068-2-27)
<b>Resistance to vibration</b>	30 g, 10 Hz ... 2,000 Hz (EN 60068-2-6)

<sup>1)</sup> With mating connector fitted.

<sup>2)</sup> These values relate to all mechanical versions including recommended accessories unless otherwise noted.

### Certificates

<b>EU declaration of conformity</b>	✓
<b>UK declaration of conformity</b>	✓
<b>ACMA declaration of conformity</b>	✓
<b>China RoHS</b>	✓
<b>cULus certificate</b>	✓
<b>Information according to Art. 3 of Data Act (Regulation EU 2023/2854)</b>	✓

### Classifications

<b>ECLASS 5.0</b>	27270501
<b>ECLASS 5.1.4</b>	27270501
<b>ECLASS 6.0</b>	27270590
<b>ECLASS 6.2</b>	27270590
<b>ECLASS 7.0</b>	27270501
<b>ECLASS 8.0</b>	27270501
<b>ECLASS 8.1</b>	27270501
<b>ECLASS 9.0</b>	27270501
<b>ECLASS 10.0</b>	27270501
<b>ECLASS 11.0</b>	27270501
<b>ECLASS 12.0</b>	27270501
<b>ETIM 5.0</b>	EC001486
<b>ETIM 6.0</b>	EC001486
<b>ETIM 7.0</b>	EC001486
<b>ETIM 8.0</b>	EC001486
<b>UNSPSC 16.0901</b>	41112113

Dimensional drawing

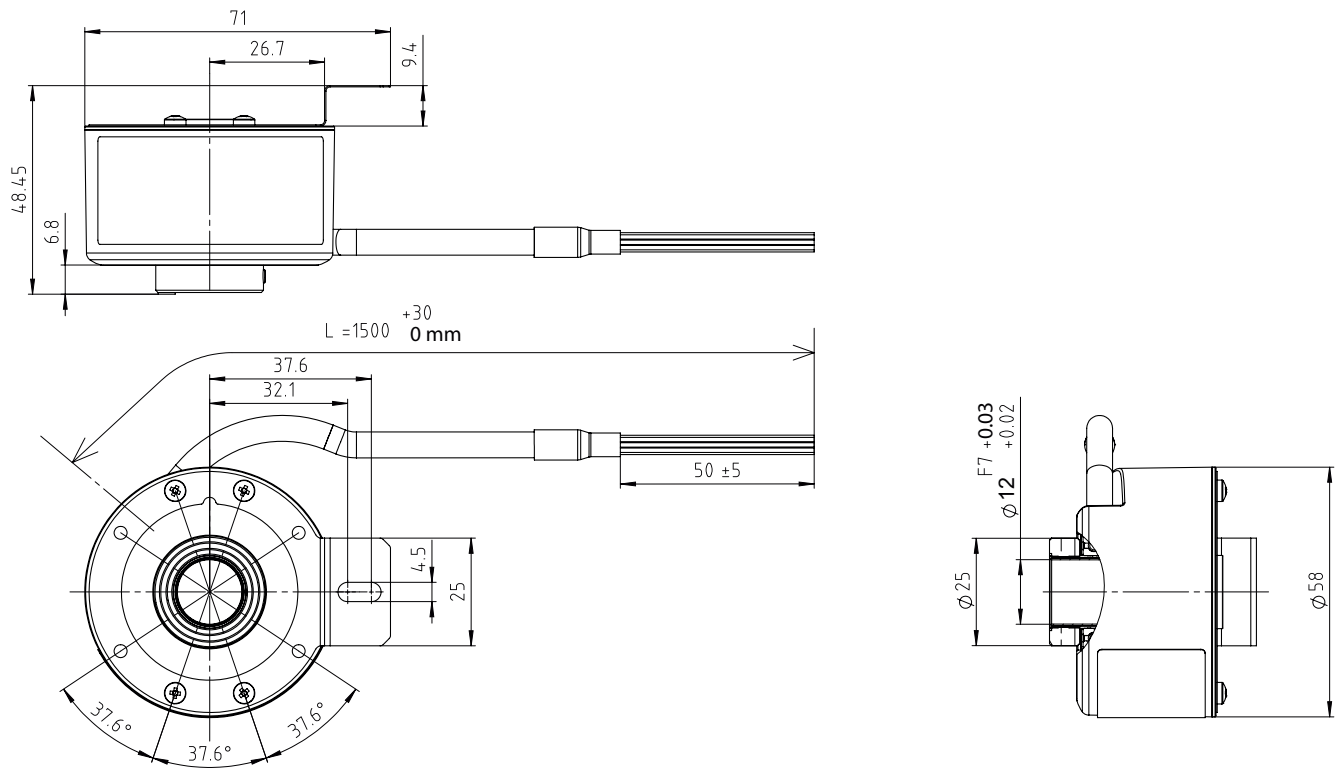

Dimensions in mm (inch)

Attachment specifications Through hollow shaft with rear clamping

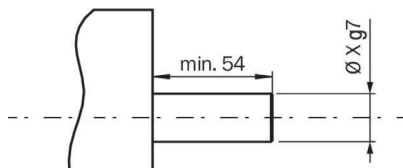



customer side

## PIN assignment

Wire colour	TTL/HTL signal	Explanation
Green	A-	Signal wire
Brown	A	Signal wire
Pink	B-	Signal wire
Grey	B	Signal wire
Black	Z-	Signal wire
Red	Z	Signal wire
White / Green	GND	Ground connection of the encoder
Brown / Green	+Us	Supply voltage
	Screen	Screen connected to housing on encoder side.

## Type label Packaging label

<b>Getriebebau NORD GmbH &amp; Co. KG</b> <b>www.nord.com</b>	<b>Mat. Nr.: 19651802</b>
	<b>Lines LINE VDC VL VT</b>
<b>DRIVESYSTEMS</b>	<b>Incr. Encoder</b>
<b>SICK</b>	<b>DBS60E- REAZGS329</b>
<b>Sick, D-79183 Waldkirch</b>	<b>Ident. Nr. YYWW - cn</b>
	<b>1112070 SERIALNO</b>
	
	<b>Made in Malaysia</b>

Type label Encoder label (second label fixed on packaging)



**Mat. Nr.:**  
19651802

DRIVESYSTEMS  
**SICK** Incr. Encoder  
DBS60E- REAZGS329

Ident. Nr. YYWW - cn  
1112070 **SERIALNO**



Made in Malaysia

Lines LINE VDC VL VT

**UL** <sup>®Class 2</sup> low-voltage limited energy circuit

**EAC** **CE** **25**

Signal	Wire Color	Signal	Wire Color
+ US	BN/GN	A	BN
GND	WH/GN	A-	GN
Z	RD	B	GY
Z-	BK	B-	PK

Diagrams Signal outputs for electrical interfaces TTL and HTL

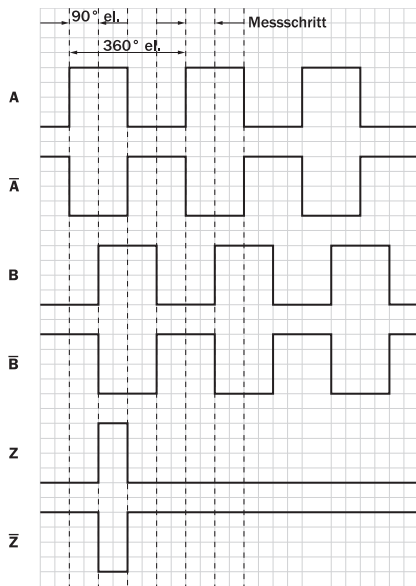

Cw with view on the encoder shaft in direction "A", compare dimensional drawing.

Supply voltage	Output
4,5 V ... 5,5 V	TTL

Diagrams

Pulses per revolution



## SICK AT A GLANCE

SICK is one of the leading manufacturers of intelligent sensors and sensor solutions for industrial applications. A unique range of products and services creates the perfect basis for controlling processes securely and efficiently, protecting individuals from accidents and preventing damage to the environment.

We have extensive experience in a wide range of industries and understand their processes and requirements. With intelligent sensors, we can deliver exactly what our customers need. In application centers in Europe, Asia and North America, system solutions are tested and optimized in accordance with customer specifications. All this makes us a reliable supplier and development partner.

Comprehensive services complete our offering: SICK LifeTime Services provide support throughout the machine life cycle and ensure safety and productivity.

For us, that is “Sensor Intelligence.”

## WORLDWIDE PRESENCE:

Contacts and other locations –[www.sick.com](http://www.sick.com)