



DBS60E-RECZGS321

DBS60

INCREMENTAL ENCODERS

SICK
Sensor Intelligence.



Illustration may differ



Ordering information

Type	part no.
DBS60E-RECZGS321	1112062

Other models and accessories → www.sick.com/DBS60

Detailed technical data

Features

Special device	✓
Specialty	8-wire PUR cable, universal, 1.5 m, open cable end with ESD bag at the cable end, customer-specific wire colors, enclosure rating IP66, customer-specific encoder label with Getriebbau NORD part number: 19651811 Second and identical encoder label fastened to packaging, customer-specific packaging label, no operating instructions (can be accessed digitally), device is exclusively for GBN
Standard reference device	DBS60E-RHCKG4096
Additional information	Getriebbau NORD part number: 19651811

Safety-related parameters

MTTF_D (mean time to dangerous failure)	500 years (EN ISO 13849-1) ¹⁾
--	--

¹⁾ This product is a standard product and does not constitute a safety component as defined in the Machinery Directive. Calculation based on nominal load of components, average ambient temperature 40 °C, frequency of use 8760 h/a. All electronic failures are considered hazardous. For more information, see document no. 8015532.

Performance

Pulses per revolution	4,096
Measuring step	≤ 90 °, electric/pulses per revolution
Measuring step deviation	± 36 ° / pulses per revolution
Error limits	Measuring step deviation x 3
Duty cycle	≤ 0.5 ± 10 %

Interfaces

Communication interface	Incremental
Communication Interface detail	TTL / RS-422
Number of signal channels	6-channel
Initialization time	< 5 ms ¹⁾
Output frequency	+ 300 kHz ²⁾
Load current	≤ 30 mA, per channel

¹⁾ Valid signals can be read once this time has elapsed.

²⁾ Up to 450 kHz on request.

Power consumption	≤ 0.5 W (without load)
--------------------------	------------------------

1) Valid signals can be read once this time has elapsed.

2) Up to 450 kHz on request.

Electronics

Connection type	Special version
Connection type Detail	8-wire PUR cable, universal, 1.5 m, open cable end with ESD bag at the cable end, customer-specific wire colors, enclosure rating IP66, customer-specific encoder label with Getriebebau NORD part number: 19651811
Supply voltage	10 ... 30 V
Reference signal, number	1
Reference signal, position	90°, electric, logically gated with A and B
Reverse polarity protection	✓
Short-circuit protection of the outputs	✓ ¹⁾

1) Short-circuit opposite to another channel or GND permissible for max. 60 s. No protection signal against U_S .

Mechanics

Mechanical design	Through hollow shaft
Shaft diameter	12 mm Rear clamping
Flange type / stator coupling	1-sided stator coupling, slot, screw hole circle radius 32.1 mm–37.6 mm
Weight	+ 0.25 kg ¹⁾
Shaft material	Stainless steel
Flange material	Aluminum
Housing material	Aluminum
Material, cable	PUR
Start up torque	+ 2.6 Ncm (+20 °C)
Operating torque	2.5 Ncm (+20 °C)
Permissible movement static	± 0.3 mm (radial) ± 0.5 mm (axial) ²⁾
Permissible movement dynamic	± 0.1 mm (radial) ± 0.2 mm (axial) ²⁾
Operating speed	6,000 min ⁻¹ ³⁾
Maximum operating speed	9,000 min ⁻¹ ⁴⁾
Moment of inertia of the rotor	50 gcm ²
Bearing lifetime	3.6 x 10 ⁹ revolutions
Angular acceleration	≤ 500,000 rad/s ²

1) Based on encoder with male connector or cable with male connector.

2) Not applicable for stator coupling type C and K.

3) Allow for self-heating of 2.6 K per 1,000 rpm when designing the operating temperature range.

4) Maximum speed which does not cause mechanical damage to the encoder. Impact on the service life and signal quality is possible. Please note the maximum output frequency.

Ambient data

EMC	According to EN 61000-6-2 and EN 61000-6-3
Enclosure rating	IP66, housing side (IEC 60529) ¹⁾ IP66, shaft side (IEC 60529)
Permissible relative humidity	90 % (Condensation not permitted)
Operating temperature range	-25 °C ... +80 °C, at maximum 3,000 pulses per revolution ²⁾
Storage temperature range	-40 °C ... +100 °C, without package
Resistance to shocks	250 g, 3 ms (EN 60068-2-27)
Resistance to vibration	30 g, 10 Hz ... 2,000 Hz (EN 60068-2-6)

¹⁾ With mating connector fitted.

²⁾ These values relate to all mechanical versions including recommended accessories unless otherwise noted.

Certificates

EU declaration of conformity	✓
UK declaration of conformity	✓
ACMA declaration of conformity	✓
China RoHS	✓
cULus certificate	✓
Information according to Art. 3 of Data Act (Regulation EU 2023/2854)	✓

Classifications

ECLASS 5.0	27270501
ECLASS 5.1.4	27270501
ECLASS 6.0	27270590
ECLASS 6.2	27270590
ECLASS 7.0	27270501
ECLASS 8.0	27270501
ECLASS 8.1	27270501
ECLASS 9.0	27270501
ECLASS 10.0	27270501
ECLASS 11.0	27270501
ECLASS 12.0	27270501
ETIM 5.0	EC001486
ETIM 6.0	EC001486
ETIM 7.0	EC001486
ETIM 8.0	EC001486
UNSPSC 16.0901	41112113

Dimensional drawing

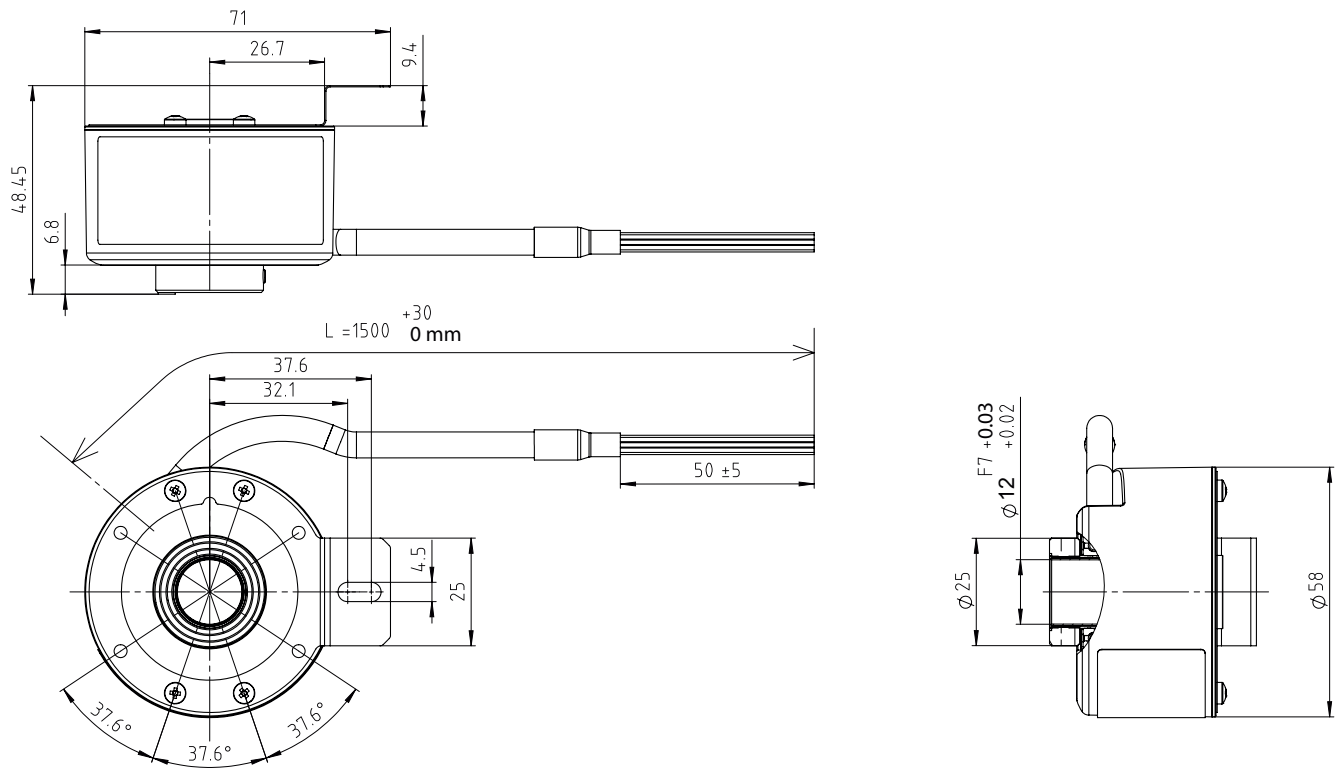

Dimensions in mm (inch)

Attachment specifications Through hollow shaft with rear clamping

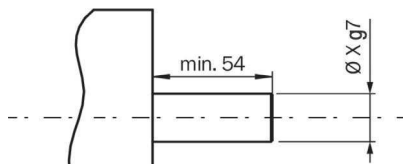

customer side

PIN assignment

Wire colour	TTL/HTL signal	Explanation
Green	A-	Signal wire
Brown	A	Signal wire
Pink	B-	Signal wire
Grey	B	Signal wire
Black	Z-	Signal wire
Red	Z	Signal wire
White / Green	GND	Ground connection of the encoder
Brown / Green	+Us	Supply voltage
	Screen	Screen connected to housing on encoder side.

Type label Encoder label (second label fixed on packaging)



Mat. Nr.: 19651811

DRIVESYSTEMS

SICK Incr. Encoder

DBS60E- RECZGS321

Ident. Nr. YYWW - cn

1112062 SERIALNO



Made in Malaysia

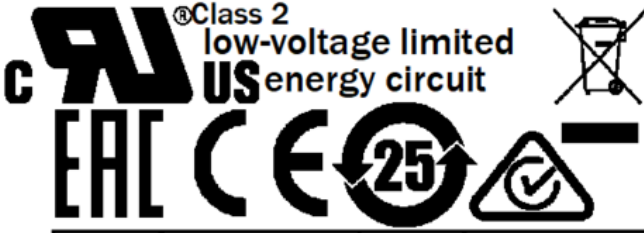

Lines LINE VDC VL VT

Class 2
low-voltage limited energy circuit



Signal	Wire Color	Signal	Wire Color
+ US	BN/GN	A	BN
GND	WH/GN	A-	GN
Z	RD	B	GY
Z-	BK	B-	PK

Type label Packaging label

Getriebebau NORD GmbH & Co. KG www.nord.com  DRIVESYSTEMS SICK Sick, D-79183 Waldkirch	Mat. Nr.: 19651811 Lines LINE VDCVL VT Incr. Encoder DBS60E- RECZGS321 Ident. Nr. YYWW - cn 1112062 SERIALNO  Made in Malaysia
---	---

Diagrams Signal outputs for electrical interfaces TTL and HTL

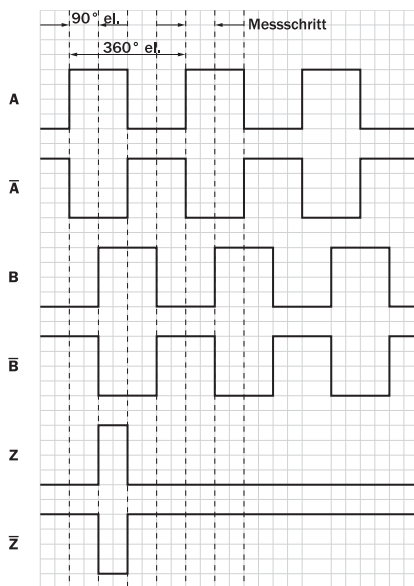

Cw with view on the encoder shaft in direction "A", compare dimensional drawing.

Supply voltage	Output
10 V ... 30 V	TTL

Diagrams

Pulses per revolution

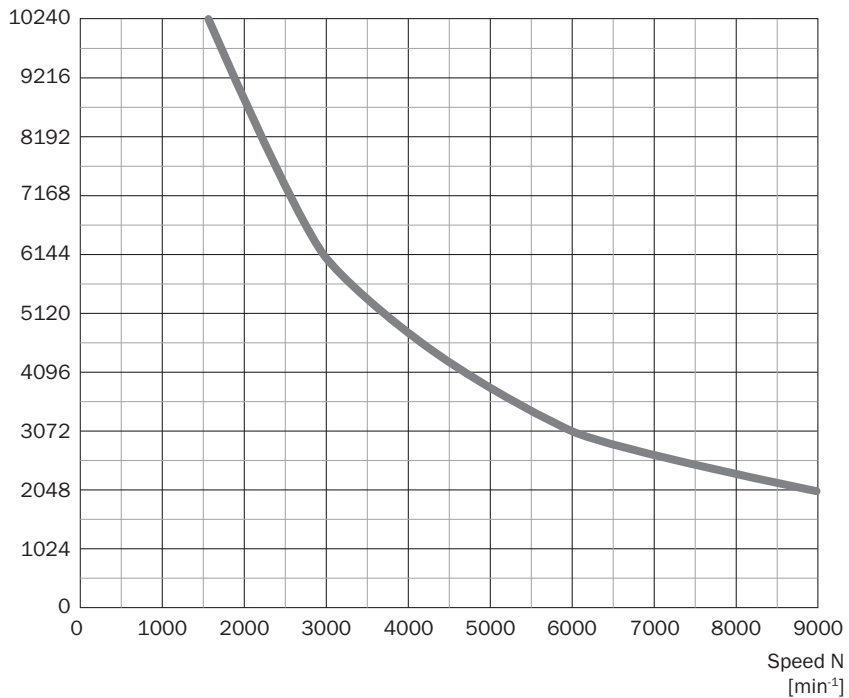

SICK AT A GLANCE

SICK is one of the leading manufacturers of intelligent sensors and sensor solutions for industrial applications. A unique range of products and services creates the perfect basis for controlling processes securely and efficiently, protecting individuals from accidents and preventing damage to the environment.

We have extensive experience in a wide range of industries and understand their processes and requirements. With intelligent sensors, we can deliver exactly what our customers need. In application centers in Europe, Asia and North America, system solutions are tested and optimized in accordance with customer specifications. All this makes us a reliable supplier and development partner.

Comprehensive services complete our offering: SICK LifeTime Services provide support throughout the machine life cycle and ensure safety and productivity.

For us, that is “Sensor Intelligence.”

WORLDWIDE PRESENCE:

Contacts and other locations –www.sick.com