



LFP0700-G7DMC

LFP Inox

LEVEL SENSORS

SICK
Sensor Intelligence.



Ordering information

| Type | part no. |
|---------------|----------|
| LFP0700-G7DMC | 1111347 |

Other models and accessories → www.sick.com/LFP_Inox

Illustration may differ



Detailed technical data

Features

| | |
|----------------------------|------------------------------|
| Medium | Fluids |
| Measurement | Switch, Continuous |
| Design | Remote amplifier |
| Probe type | Rod probe in hygienic design |
| Probe length | 700 mm |
| Process pressure | -1 bar ... 16 bar |
| Process temperature | -20 °C ... +180 °C |

Performance

| | |
|---|--|
| Accuracy of sensor element | ± 5 mm |
| Reproducibility | ≤ 2 mm |
| Resolution | 1 mm |
| Response time | 400 ms ¹⁾ |
| Dielectricity constant | ≥ 5 for rod probe ≥ 1.8 with coaxial tube |
| Conductivity | No limitation |
| Deactivated area at process connection | 25 mm ²⁾ |
| Deactivated area at end of probe | ≥ 10 mm ³⁾ |
| MTTF | 194.3 years (EN ISO 13849-1) |
| Display | ✓ |

¹⁾ Dependent on measuring mode (high speed < 400 ms, high accuracy < 2,800 ms).

²⁾ With parameterized container with water under reference conditions, otherwise 40 mm.

³⁾ With water under reference conditions.

Electronics

| | |
|--------------------------------|---|
| Communication interface | IO-Link |
| Supply voltage | 12 V DC ... 30 V DC ¹⁾ |
| Power consumption | ≤ 75 mA at 24 V DC without output load |
| Initialization time | ≤ 2 s |
| Protection class | III |
| Connection type | M12 round connector x 1, 8-pin |
| Length of cable | 3.3 m |
| Output signal | 1 x PNP + 3 x PNP/NPN + 4 mA ... 20 mA / 0 V ... 10 V |
| Output load | 4 mA ... 20 mA < 500 Ohm at U _v > 13,5 V, 4 mA ... 20 mA < 400 Ohm at U _v > 12 V, 0 V ... 10 V > 750 Ohm at U _v 14 ≥ V |
| Hysteresis | ≥ 2 mm ²⁾ |
| Output current | < 100 mA |
| Inductive load | < 1 H |
| Capacitive load | < 100 nF |
| Enclosure rating | IP67 (EN 60529) IP69 (EN 60529) |
| Temperature drift | < 0.1 mm/K |
| Lower signal level | 3.8 mA ... 4 mA, 0 V |
| Upper signal level | 20 mA ... 20.5 mA, 10.5 V |
| EMC | EN 61326-2-3, 2014/30/EU |

¹⁾ All connections are polarity protected. All outputs are overload and short-circuit protected.

²⁾ Freely adjustable.

Mechanics

| | |
|-------------------------------|---------------------------------------|
| Wetted parts | Stainless steel 1.4404 / 316L PEEK |
| Surface roughness | Ra ≤ 0,8 μm |
| Process connection | G ¾ A |
| Housing material | Stainless steel 1,4305 |
| Housing design | With closed cover |
| Max. probe load | ≤ 6 Nm |
| Material coaxial cable | FEP |

Ambient data

| | |
|--|------------------------|
| Ambient operating temperature | -20 °C ... +60 °C |
| Ambient temperature, storage | -40 °C ... +80 °C |
| Ambient temperature coaxial cable | -20 °C ... +60 °C |
| Outdoor use | Only with weather hood |

Certificates

| | |
|---|---|
| EU declaration of conformity | ✓ |
| UK declaration of conformity | ✓ |
| ACMA declaration of conformity | ✓ |
| Moroccan declaration of conformity | ✓ |

| | |
|--|---|
| China RoHS | ✓ |
| FDA certificate | ✓ |
| cULus certificate | ✓ |
| IO-Link certificate | ✓ |
| Food contact material manufacturer declaration | ✓ |
| Information according to Art. 3 of Data Act (Regulation EU 2023/2854) | ✓ |

Classifications

| | |
|-----------------------|----------|
| ECLASS 5.0 | 27200513 |
| ECLASS 5.1.4 | 27200513 |
| ECLASS 6.0 | 27200513 |
| ECLASS 6.2 | 27200513 |
| ECLASS 7.0 | 27200513 |
| ECLASS 8.0 | 27200513 |
| ECLASS 8.1 | 27200513 |
| ECLASS 9.0 | 27200513 |
| ECLASS 10.0 | 27200513 |
| ECLASS 11.0 | 27200513 |
| ECLASS 12.0 | 27200513 |
| ETIM 5.0 | EC001447 |
| ETIM 6.0 | EC001447 |
| ETIM 7.0 | EC001447 |
| ETIM 8.0 | EC001447 |
| UNSPSC 16.0901 | 41113710 |

Remote amplifier



All dimensions in mm (inch)
 Dimensions in mm (inch)

Connection type M12 round connector, 8-pin

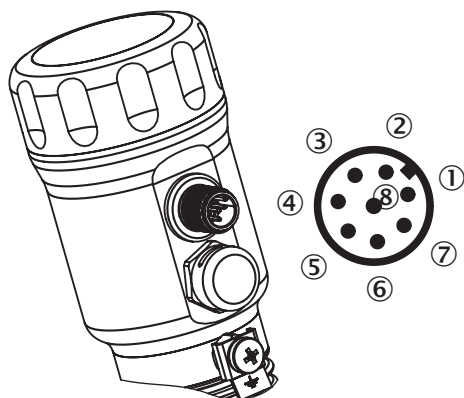















The wire colors for 8-pin cables are not uniform. Always note the pin assignment of the sensor.

① L⁺: Supply voltage

- ② Q₂: Switching output 2, PNP/NPN
- ③ M: Ground, reference ground for current-/voltage output
- ④ C/Q₁: Switching output 1, PNP/IO-Link-communication
- ⑤ Q₃: Switching output 3, PNP/NPN
- ⑥ Q₄: Switching output 4, PNP/NPN
- ⑦ Q_A: Analog current-/voltage output
- ⑧ No function







Recommended accessories





Other models and accessories → www.sick.com/LFP_Inox

| | Brief description | Type | part no. |
|---|---|-------------------------|----------|
| device protection and care | | | |
|  | <ul style="list-style-type: none"> Description: Weather protection cover for LFP Inox, material: 304 | APR-WP-LFP001-0001 | 2069530 |
|  | <ul style="list-style-type: none"> Description: Cover for LFP Inox with inspection window, material 1.4305 and PMMA | Cover with front screen | 2067267 |
|  | <ul style="list-style-type: none"> Description: Cover closed, material 1.4305 | Cover closed | 2067269 |
|  | <ul style="list-style-type: none"> Description: Coaxial tube for LFP with process connection G 3/4, process connection of coax probe G 3/4, material 1.4571/316TI, for probe length 1900 mm | LFPCT-1900G1 | 2068156 |
|  | <ul style="list-style-type: none"> Description: Coaxial tube for LFP with process connection G 3/4, process connection of coaxial tube G 3/4, material 1.4571/316TI, for probe length 2000 mm | LFPCT-2000G1 | 2065703 |
|  | <ul style="list-style-type: none"> Description: Coaxial tube for LFP with process connection G 3/4, process connection of coaxial tube G 3/4, material 1.4571/316TI, for probe length 200 mm | LFPCT-0200G1 | 2068141 |
|  | <ul style="list-style-type: none"> Description: Coaxial tube for LFP with process connection G 3/4, process connection of coaxial tube G 3/4, material 1.4571/316TI, for probe length 300 mm | LFPCT-0300G1 | 2068142 |
|  | <ul style="list-style-type: none"> Description: Coaxial tube for LFP with process connection G 3/4, process connection of coaxial tube G 3/4, material 1.4571/316TI, for probe length 400 mm | LFPCT-0400G1 | 2068143 |
|  | <ul style="list-style-type: none"> Description: Coaxial tube for LFP with process connection G 3/4, process connection of coaxial tube G 3/4, material 1.4571/316TI, for probe length 500 mm | LFPCT-0500G1 | 2068144 |
|  | <ul style="list-style-type: none"> Description: Coaxial tube for LFP with process connection G 3/4, process connection of coaxial tube G 3/4, material 1.4571/316TI, for probe length 600 mm | LFPCT-0600G1 | 2068145 |
|  | <ul style="list-style-type: none"> Description: Coaxial tube for LFP with process connection G 3/4, process connection of coaxial tube G 3/4, material 1.4571/316TI, for probe length 700 mm | LFPCT-0700G1 | 2068146 |
|  | <ul style="list-style-type: none"> Description: Coaxial tube for LFP with process connection G 3/4, process connection of coax probe G 3/4, material 1.4571/316TI, for probe length 800 mm | LFPCT-0800G1 | 2068147 |
|  | <ul style="list-style-type: none"> Description: Coaxial probe for LFP with process connection G 3/4, process connection of coaxial tube G 3/4, material 1.4571/316TI, for probe length 900 mm | LFPCT-0900G1 | 2067507 |
|  | <ul style="list-style-type: none"> Description: Coaxial tube for LFP with process connection G 3/4, process connection of coaxial tube G 3/4, material 1.4571/316TI, for probe length 1000 mm | LFPCT-1000G1 | 2065702 |

| | Brief description | Type | part no. |
|---|--|--------------------|----------|
| Mounting systems | | | |
|  | <ul style="list-style-type: none">• Description: Centering for bypass- and immersion tube installation with diameter 40 mm ... 100 mm• Dimensions (W x H x L): 100 mm x 5 mm x 100 mm• Material: PTFE• Details: PTFE• Packing unit: 1 piece | BEF-FL-BYRD40-LFP1 | 2059612 |

| | Brief description | Type | part no. |
|---|--|---------------------|----------|
|  | <ul style="list-style-type: none"> Usable for: LFP Inox Description: Hygienic process connection adapter, Tri-Clamp 1" and 1 1/2", including acceptance test certificate 3.1; Ra ≤ 0.4 μm, hygienic in accordance with EHEDG in combination with T-seals or Tri-Clamp seals from Combifit International B.V. | BEF-HA-TCLI10-LFP2 | 2126242 |
|  | <ul style="list-style-type: none"> Description: Hygienic process connection adapter, Tri-Clamp 2"; including acceptance test certificate 3.1; Ra ≤ 0.4 μm, hygienic in accordance with EHEDG in combination with T-seals or Tri-Clamp seals from Combifit International B.V. | BEF-HA-TCLI20-LFP2 | 2126243 |
|  | <ul style="list-style-type: none"> Description: Weld-in flange, hygienic, G 3/4" including acceptance test certificate 3.1, Ra ≤ 0.4 μm Material: Stainless steel Details: Stainless steel 1.4404 | BEF-HA-SWFL54-LFP2 | 2122489 |
|  | <ul style="list-style-type: none"> Description: Hygienic process connection adapter, Tri-Clamp 1" and 1 1/2" with leakage indication port according to 3-A guidelines | BEF-HA-TCLI10-LFP3 | 2058851 |
|  | <ul style="list-style-type: none"> Description: Hygienic process connection adapter, Tri-Clamp 1" and 1 1/2"; hygienic in accordance with EHEDG in combination with T-seals or Tri-Clamp seals from Combifit International B.V. | BEF-HA-TCLI10-LFP1 | 2058808 |
|  | <ul style="list-style-type: none"> Description: Hygienic process connection adapter, Tri-Clamp 2"; hygienic in accordance with EHEDG in combination with T-seals or Tri-Clamp seals from Combifit International B.V. | BEF-HA-TCLI20-LFP1 | 2058824 |
|  | <ul style="list-style-type: none"> Description: Hygienic process connection adapter, Tri-Clamp 2 1/2"; hygienic in accordance with EHEDG in combination with T-seals or Tri-Clamp seals from Combifit International B.V. | BEF-HA-TCLI25-LFP1 | 2069518 |
|  | <ul style="list-style-type: none"> Description: Hygienic process connection adapter, Varivent connection form N; hygienic in accordance with EHEDG in combination with EPDM O-ring | BEF-HA-VAR-TYN-LFP1 | 2058822 |
|  | <ul style="list-style-type: none"> Description: Hygienic process connection adapter, coupling (DIN 11864-1) DN 25 form A with union nut; hygienic in accordance with EHEDG | BEF-HA-641D25-LFP1 | 2058795 |
|  | <ul style="list-style-type: none"> Description: Hygienic process connection adapter, coupling (DIN 11864-2) DN 25 form A; hygienic in accordance with EHEDG | BEF-HA-642D25-LFP1 | 2058823 |
|  | <ul style="list-style-type: none"> Description: Hygienic process connection adapter, clamp coupling (DIN 11864-3) BKS DN 25 form A, hygienic in accordance with EHEDG | BEF-HA-643D25-LFP1 | 2058821 |
|  | <ul style="list-style-type: none"> Description: Hygienic process connection adapter, conical coupling (DIN 11851), DN 25 with grooved cap nut; hygienic in accordance with EHEDG in combination with ASEPTO-STAR k-flex upgrade gaskets from Kieselmann GmbH or SKS gasket set DIN 11851 EHEDG with EPDM or FKM inner gasket from Siersema Komponenten Service (S.K.S.) B.V | BEF-HA-851D25-LFP1 | 2058138 |
|  | <ul style="list-style-type: none"> Description: Hygienic process connection adapter, conical coupling (DIN 11851), DN 40 with grooved cap nut, material 1.4404 (Ra ≤ 0.8 μm); hygienic in accordance with EHEDG in combination with ASEPTO-STAR k-flex upgrade gaskets from Kieselmann GmbH or SKS gasket set DIN 11851 EHEDG with EPDM or FKM inner gasket from Siersema Komponenten Service (S.K.S.) B.V | BEF-HA-851D40-LFP1 | 2058139 |

| | Brief description | Type | part no. |
|---|---|--------------------|----------|
| connectors and cables | | | |
|  | <ul style="list-style-type: none"> Description: Sensor/actuator cable, unshielded Connection type head A: Female connector, M12, 5-pin, straight Connection type head B: Flying leads Signal type: Sensor/actuator cable Cable: 2 m, 5-wire, PP Connection systems: Flying leads Note: This product is generally resistant to chemical cleaning agents (see ECOLAB) and other chemical compounds such as H2O2 and CH2O2. Before permanent installation is carried out, the material's resistance to the cleaning agent being used must be checked., Resistant against lactic acid & hydrogen peroxide (H2O2) Application: Hygienic and washdown zones, Drag chain operation, Robot, cold bending resistant, seawater resistant | DOL-1205-G02MRN | 6058494 |
|  | <ul style="list-style-type: none"> Description: Sensor/actuator cable, unshielded Connection type head A: Female connector, M12, 5-pin, straight Connection type head B: Flying leads Signal type: Sensor/actuator cable Cable: 5 m, 5-wire, PP Connection systems: Flying leads Note: This product is generally resistant to chemical cleaning agents (see ECOLAB) and other chemical compounds such as H2O2 and CH2O2. Before permanent installation is carried out, the material's resistance to the cleaning agent being used must be checked., Resistant against lactic acid & hydrogen peroxide (H2O2) Application: Hygienic and washdown zones, Drag chain operation, Robot, cold bending resistant, seawater resistant | DOL-1205-G05MRN | 6058495 |
|  | <ul style="list-style-type: none"> Description: Sensor/actuator cable, unshielded Connection type head A: Female connector, M12, 5-pin, straight Connection type head B: Flying leads Signal type: Sensor/actuator cable Cable: 10 m, 5-wire, PP Connection systems: Flying leads Note: This product is generally resistant to chemical cleaning agents (see ECOLAB) and other chemical compounds such as H2O2 and CH2O2. Before permanent installation is carried out, the material's resistance to the cleaning agent being used must be checked., Resistant against lactic acid & hydrogen peroxide (H2O2) Application: Hygienic and washdown zones, Drag chain operation, Robot, cold bending resistant, seawater resistant | DOL-1205-G10MRN | 6058496 |
|  | <ul style="list-style-type: none"> Description: Sensor/actuator cable, unshielded Connection type head A: Female connector, M12, 5-pin, straight Connection type head B: Flying leads Signal type: Sensor/actuator cable Cable: 25 m, 5-wire, PVC Connection systems: Flying leads Note: This product is generally resistant to chemical cleaning agents (see ECOLAB). Please do not use cleaning agents of any other Kind., Not resistant against lactic acid & hydrogen peroxide (H2O2) Application: Uncontaminated zones, Hygienic and washdown zones, Zones with chemicals | YF2AP5-250VB5XLEAX | 6052628 |
|  | <ul style="list-style-type: none"> Description: Sensor/actuator cable, unshielded Connection type head A: Female connector, M12, 5-pin, straight Connection type head B: Flying leads Signal type: Sensor/actuator cable Cable: 25 m, 5-wire, PP Connection systems: Flying leads Note: This product is generally resistant to chemical cleaning agents (see ECOLAB) and other chemical compounds such as H2O2 and CH2O2. Before permanent installation is carried out, the material's resistance to the cleaning agent being used must be checked., Resistant against lactic acid & hydrogen peroxide (H2O2) Application: Hygienic and washdown zones, Drag chain operation, Robot, cold bending resistant, seawater resistant | DOL-1205-G25MRN | 6058497 |
|  | <ul style="list-style-type: none"> Description: Sensor/actuator cable, unshielded Connection type head A: Female connector, M12, 5-pin, straight Connection type head B: Flying leads Signal type: Sensor/actuator cable Cable: 2 m, 5-wire, PVC Connection systems: Flying leads Note: This product is generally resistant to chemical cleaning agents (see ECOLAB). Please do not use cleaning agents of any other Kind., Not resistant against lactic acid & hydrogen peroxide (H2O2) | YF2AP5-020VB5XLEAX | 6052625 |

| | Brief description | Type | part no. |
|---|---|--------------------|----------|
|  | <ul style="list-style-type: none"> • Application: Untaminated zones, Hygienic and washdown zones, Zones with chemicals • Description: Sensor/actuator cable, unshielded • Connection type head A: Female connector, M12, 5-pin, straight • Connection type head B: Flying leads • Signal type: Sensor/actuator cable • Cable: 5 m, 5-wire, PVC • Connection systems: Flying leads • Note: This product is generally resistant to chemical cleaning agents (see ECOLAB). Please do not use cleaning agents of any other Kind., Not resistant against lactic acid & hydrogen peroxide (H2O2) • Application: Untaminated zones, Hygienic and washdown zones, Zones with chemicals | YF2AP5-050VB5XLEAX | 6052626 |
|  | <ul style="list-style-type: none"> • Description: Sensor/actuator cable, unshielded • Connection type head A: Female connector, M12, 5-pin, straight • Connection type head B: Flying leads • Signal type: Sensor/actuator cable • Cable: 10 m, 5-wire, PVC • Connection systems: Flying leads • Note: This product is generally resistant to chemical cleaning agents (see ECOLAB). Please do not use cleaning agents of any other Kind., Not resistant against lactic acid & hydrogen peroxide (H2O2) • Application: Untaminated zones, Hygienic and washdown zones, Zones with chemicals | YF2AP5-100VB5XLEAX | 6052627 |
|  | <ul style="list-style-type: none"> • Description: Sensor/actuator cable, unshielded • Connection type head A: Female connector, M12, 5-pin, straight • Connection type head B: Flying leads • Signal type: Sensor/actuator cable • Cable: 20 m, 5-wire, PP • Connection systems: Flying leads • Note: This product is generally resistant to chemical cleaning agents (see ECOLAB) and other chemical compounds such as H2O2 and CH2O2. Before permanent installation is carried out, the material's resistance to the cleaning agent being used must be checked., Resistant against lactic acid & hydrogen peroxide (H2O2) • Application: Hygienic and washdown zones, Drag chain operation, Robot, cold bending resistant, seawater resistant | YF2AP5-200PA3XLEAX | 2146868 |
|  | <ul style="list-style-type: none"> • Description: Sensor/actuator cable, unshielded • Connection type head A: Female connector, M12, 5-pin, straight • Connection type head B: Flying leads • Signal type: Sensor/actuator cable • Cable: 40 m, 5-wire, PP • Connection systems: Flying leads • Note: This product is generally resistant to chemical cleaning agents (see ECOLAB) and other chemical compounds such as H2O2 and CH2O2. Before permanent installation is carried out, the material's resistance to the cleaning agent being used must be checked., Resistant against lactic acid & hydrogen peroxide (H2O2) • Application: Hygienic and washdown zones, Drag chain operation, Robot, cold bending resistant, seawater resistant | YF2AP5-400PA3XLEAX | 2146869 |
|  | | CBL-CX-003300-LFPI | 2077797 |

SICK AT A GLANCE

SICK is one of the leading manufacturers of intelligent sensors and sensor solutions for industrial applications. A unique range of products and services creates the perfect basis for controlling processes securely and efficiently, protecting individuals from accidents and preventing damage to the environment.

We have extensive experience in a wide range of industries and understand their processes and requirements. With intelligent sensors, we can deliver exactly what our customers need. In application centers in Europe, Asia and North America, system solutions are tested and optimized in accordance with customer specifications. All this makes us a reliable supplier and development partner.

Comprehensive services complete our offering: SICK LifeTime Services provide support throughout the machine life cycle and ensure safety and productivity.

For us, that is “Sensor Intelligence.”

WORLDWIDE PRESENCE:

Contacts and other locations –www.sick.com