



GTE6L-E6211

G6

PHOTOELECTRIC SENSORS

SICK
Sensor Intelligence.



Illustration may differ



Ordering information

| Type | part no. |
|-------------|----------|
| GTE6L-E6211 | 1109688 |

Other models and accessories → www.sick.com/G6

Detailed technical data

Features

| | |
|-------------------------------------------------------------------------------------------------|---------------------------------------------------------------------------------------|
| Functional principle | Photoelectric proximity sensor |
| Functional principle detail | Energetic |
| Sensing range | |
| Sensing range min. | 0 mm |
| Sensing range max. | 450 mm |
| Reference object | Object with 90% remission factor (complies with standard white according to DIN 5033) |
| Recommended sensing range for the best performance | 5 mm ... 400 mm |
| Emitted beam | |
| Light source | Laser |
| Type of light | Visible red light |
| Shape of light spot | Point-shaped |
| Light spot size (distance) | Ø 0.4 mm (150 mm) |
| Maximum dispersion of the emitted beam around the standardized transmission axis (squint angle) | < +/- 1.5° (at T _U = +23 °C) |
| Key laser figures | |
| Normative reference | IEC 60825-1 / CDRH 21 CFR 1040.10 & 1040.11 |
| Laser class | 1 ¹⁾ |
| Wave length | 680 nm |
| Pulse duration | 2 µs |
| Maximum pulse power | ≤ 11.9 mW |
| Average service life | 100,000 h at T _a = +25 °C |
| Smallest detectable object (MDO) typ. | |

¹⁾ Do not intentionally look into the laser beam. Never point the laser beam at people's eyes.

| | | |
|-------------------|-----------------------|---------------------------------------------------------------------------------------------------------------------|
| | | 0.4 mm, at 150 mm distance (object with 90% remission factor (corresponds to standard white according to DIN 5033)) |
| Adjustment | Potentiometer | For setting the sensing range, 5 rotations |
| | Operating mode switch | For inverting the switching function (light/dark switching) |
| Display | LED green | Operating indicator Static on: power on |
| | LED yellow | Status of received light beam Static on: object present Static off: object not present |

¹⁾ Do not intentionally look into the laser beam. Never point the laser beam at people's eyes.

Safety-related parameters

| | |
|-------------------------------------|-----------|
| MTF_D | 662 years |
| DC_{avg} | 0 % |
| T_M (mission time) | 10 years |

Electronics

| | | |
|-------------------------------------|-------------------------------------------------|------------------------------------------------------------------------------------------------------------|
| Supply voltage U_B | 10 V DC ... 30 V DC ¹⁾ | |
| Ripple | < 5 V _{pp} | |
| Usage category | DC-13 (According to EN 60947-5-2) | |
| Current consumption | ≤ 20 mA, without load. At U _B = 24 V | |
| Protection class | III | |
| Digital output | Number | 2 (Complementary) |
| | Type | NPN |
| | Switching mode | Light/dark switching |
| | Signal voltage NPN HIGH/LOW | Approx. U _B / ≤ 3 V |
| | Output current I _{max.} | ≤ 100 mA ²⁾ |
| | Circuit protection outputs | Reverse polarity protected |
| | | Overcurrent protected |
| | | Short-circuit protected |
| Response time | ≤ 625 μs | |
| Switching frequency | 1,000 Hz ³⁾ | |
| Pin/Wire assignment | Function of pin 4/black (BK) | Digital output, light switching, object present → output Q LOW |
| | Function of pin 4/black (BK) – detail | The pin 4 function of the sensor can be switched Additional possible settings via operating mode switch |
| | Function of pin 2/white (WH) | Digital output, dark switching, object present → output \bar{Q} HIGH |
| | Function of pin 2/white (WH) – detail | The pin 2 function of the sensor can be switched Additional possible settings via operating mode switch |

¹⁾ Limit values.

²⁾ At U_B > 24 V, I max. = 50 mA.

³⁾ With light/dark ratio 1:1.

Mechanics

| | |
|-------------------------------|---------------------------------------------|
| Housing | Rectangular |
| Dimensions (W x H x D) | 12 mm x 31.5 mm x 21 mm |
| Connection | Cable with M8 male connector, 4-pin, 336 mm |
| Connection detail | |
| Deep-freeze property | Do not bend below 0 °C |
| Conductor size | 0.14 mm ² |
| Cable diameter | Ø 8 mm |
| Length of cable (L) | 300 mm |
| Material | |
| Housing | Plastic, ABS |
| Front screen | Plastic, PMMA |
| Cable | Plastic, PVC |
| Male connector | Metal, copper alloy (C3604 CUZN39PB3) |
| Weight | Approx. 60 g |

Ambient data

| | |
|--------------------------------------------|---------------------------------------------------------------------------------------------------|
| Enclosure rating | IP67 (EN 60529) |
| Ambient operating temperature | -20 °C ... +50 °C ^{1) 2)} |
| Ambient temperature, storage | -40 °C ... +70 °C |
| Typ. Ambient light immunity | Sunlight: ≤ 13,000 lx |
| Shock resistance | 30 g, 11 ms (3 positive and 3 negative shocks along X, Y, Z axes, 18 total shocks (EN60068-2-27)) |
| Vibration resistance | 10 Hz ... 55 Hz (Amplitude 0.5 mm, 3 x 30 min (EN60068-2-6)) |
| Air humidity | 35 % ... 95 %, relative humidity (no condensation) |
| Electromagnetic compatibility (EMC) | EN 60947-5-2 |
| UL File No. | NRKH.E348498 & NRKH7.E348498 |

¹⁾ As of T_a => 45 °C, a max. supply voltage U_B = 24 V and a max. load current I_{max.} = 50 mA is permitted.

²⁾ Below T_u = -20 °C, a warm-up time of 3 seconds is required.

Certificates

| | |
|---------------------------------------------------------------|---|
| EU declaration of conformity | ✓ |
| UK declaration of conformity | ✓ |
| ACMA declaration of conformity | ✓ |
| Moroccan declaration of conformity | ✓ |
| China RoHS | ✓ |
| cULus certificate | ✓ |
| Laser safety (IEC 60825-1) declaration of manufacturer | ✓ |

Classifications

| | |
|---------------------|----------|
| ECLASS 5.0 | 27270903 |
| ECLASS 5.1.4 | 27270903 |
| ECLASS 6.0 | 27270903 |

| | |
|-----------------------|----------|
| ECLASS 6.2 | 27270903 |
| ECLASS 7.0 | 27270903 |
| ECLASS 8.0 | 27270903 |
| ECLASS 8.1 | 27270903 |
| ECLASS 9.0 | 27270903 |
| ECLASS 10.0 | 27270904 |
| ECLASS 11.0 | 27270904 |
| ECLASS 12.0 | 27270903 |
| ETIM 5.0 | EC001821 |
| ETIM 6.0 | EC001821 |
| ETIM 7.0 | EC002719 |
| ETIM 8.0 | EC002719 |
| UNSPSC 16.0901 | 39121528 |

Dimensional drawing

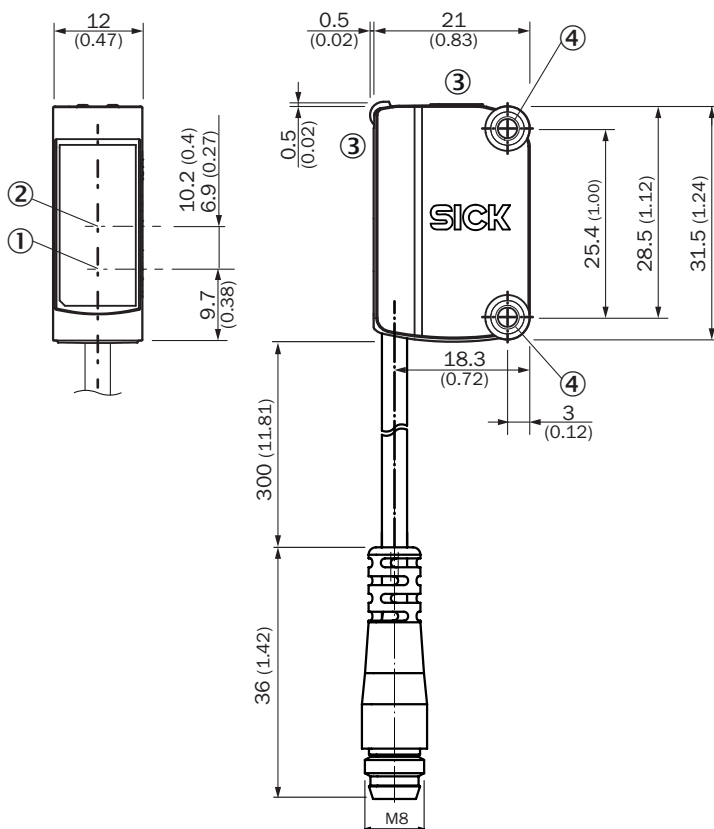

Dimensions in mm (inch)

- ① Center of optical axis, sender
- ② Center of optical axis, receiver
- ③ display and adjustment elements
- ④ Mounting holes M3

display and adjustment elements



- ① Potentiometer
- ② LED yellow
- ③ LED green
- ④ operating mode switch

Connection type Male connector M8, 4-pin

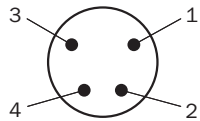

Connection diagram Cd-084

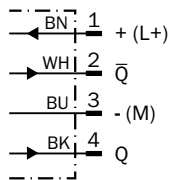

Truth table NPN - light switching

| | Light switching Q (normally open) | |
|-------------------------|-----------------------------------|-----------------------------|
| | Object not present → Output HIGH | Object present → Output LOW |
| Light receive | ✗ | ✔ |
| Light receive indicator | ✗ | ☀ |
| Load resistance | ✗ | ⚡ |
| | | |

Truth table NPN - dark switching

| | Dark switching \bar{Q} (normally closed) | |
|-------------------------|--------------------------------------------|------------------------------|
| | Object not present → Output LOW | Object present → Output HIGH |
| Light receive | ✗ | ✔ |
| Light receive indicator | ✗ | ☀ |
| Load resistance | ⚡ | ✗ |
| | | |

Characteristic curve

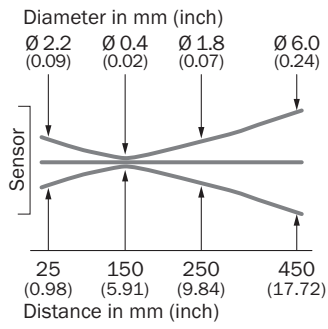

Characteristic curve

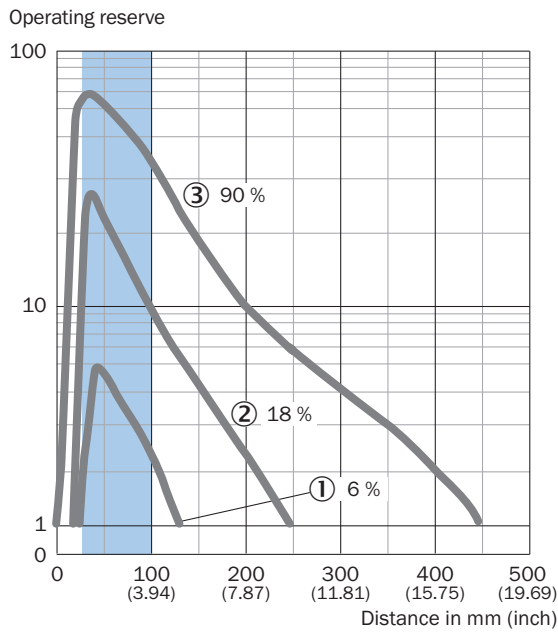

Recommended sensing range for the best performance

- ① Black object, 6% remission factor
- ② Gray object, 18% remission factor
- ③ White object, 90% remission factor

Sensing range diagram

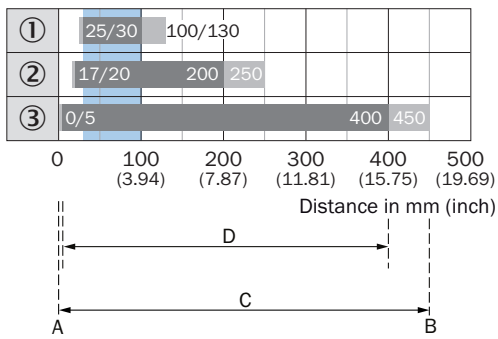



- A = Sensing range min. in mm
- B = Sensing range max. in mm
- C = Viewing range
- D = Adjustable switching threshold



Recommended sensing range for the best performance

- ① Black object, 6% remission factor
- ② Gray object, 18% remission factor
- ③ White object, 90% remission factor

Recommended accessories

Other models and accessories → www.sick.com/G6

| | Brief description | Type | part no. |
|-------------------------------------------------------------------------------------|-------------------------------------------------------------------------------------------------------------------------------------------------------------------------------------------------------------------------------------------------------------------------------------------------------------------------------------------------------------------------------------------------|----------------|----------|
| Mounting systems | | | |
|  | <ul style="list-style-type: none"> • Description: Clamp bar to fix G6 sensors on rods of 12 mm, clamp-on design up to 4 mm wall thickness • Material: Steel • Details: Aluminum (clamp bar), stainless steel (bracket) • Items supplied: Clamp bar mounting and clamp function, mounting bracket, mounting hardware | BEF-KHS-IS12G6 | 2086865 |
|  | <ul style="list-style-type: none"> • Description: Mounting bracket for wall mounting • Material: Stainless steel • Details: Stainless steel • Items supplied: Mounting hardware included • Suitable for: W8, W8G, W8 Laser, W8 Inox, G6, G6 Inox, W100 Laser, W100-2, KTM Core, KTM Prime, CSM, LUTM, W4S | BEF-W100-A | 5311520 |
|  | <ul style="list-style-type: none"> • Material: Stainless steel • Details: Stainless steel (1.4301) • Suitable for: W4S, W4S | BEF-WN-G6 | 2062909 |

| | Brief description | Type | part no. |
|-----------------------------------------------------------------------------------|-----------------------------------------------------------------------------------------------------------------------------------------------------------------------------------------------------------------------------------------------------------------------------------------------------------------------------------------------------------------------------------------------------------------------------------------------------------------------------------------|--------------------|----------|
| connectors and cables | | | |
|  | <ul style="list-style-type: none"> • Description: Unshielded • Connection type head A: Male connector, M8, 4-pin, straight, A-coded • Connection systems: Screw-type terminals • Permitted cross-section: 0.14 mm² ... 0.5 mm² | STE-0804-G | 6037323 |
|  | <ul style="list-style-type: none"> • Description: Sensor/actuator cable, unshielded • Connection type head A: Female connector, M8, 4-pin, straight, A-coded • Connection type head B: Flying leads • Signal type: Sensor/actuator cable • Cable: 5 m, 4-wire, PUR, halogen-free • Application: Drag chain operation, Zones with oils and lubricants, Robot, Drag chain operation | YF8U14-050UA3XLEAX | 2094792 |
|  | <ul style="list-style-type: none"> • Description: Sensor/actuator cable, unshielded • Connection type head A: Female connector, M8, 4-pin, straight, A-coded • Connection type head B: Flying leads • Signal type: Sensor/actuator cable • Cable: 5 m, 4-wire, PVC • Application: Uncontaminated zones, Zones with chemicals | YF8U14-050VA3XLEAX | 2095889 |

SICK AT A GLANCE

SICK is one of the leading manufacturers of intelligent sensors and sensor solutions for industrial applications. A unique range of products and services creates the perfect basis for controlling processes securely and efficiently, protecting individuals from accidents and preventing damage to the environment.

We have extensive experience in a wide range of industries and understand their processes and requirements. With intelligent sensors, we can deliver exactly what our customers need. In application centers in Europe, Asia and North America, system solutions are tested and optimized in accordance with customer specifications. All this makes us a reliable supplier and development partner.

Comprehensive services complete our offering: SICK LifeTime Services provide support throughout the machine life cycle and ensure safety and productivity.

For us, that is “Sensor Intelligence.”

WORLDWIDE PRESENCE:

Contacts and other locations –www.sick.com