



# AHM36I-SBQC000A30

AHS/AHM36

**ABSOLUTE ENCODERS**

**SICK**  
Sensor Intelligence.



Illustration may differ



### Ordering information

| Type              | part no. |
|-------------------|----------|
| AHM36I-SBQC000A30 | 1109443  |

Other models and accessories → [www.sick.com/AHS\\_AHM36](http://www.sick.com/AHS_AHM36)

### Detailed technical data

#### Safety-related parameters

|  |                            |
|--|----------------------------|
| <b>MTTF<sub>D</sub> (mean time to dangerous failure)</b> | 240 years (EN ISO 13849-1) |
|--|----------------------------|

#### Performance

|   |                                  |
|---|----------------------------------|
| <b>Number of steps per revolution (max. resolution)</b>                         | 16,384 (14 bit)                  |
| <b>Number of revolutions</b>  | 4,096 (12 bit)                   |
| <b>Max. resolution (number of steps per revolution x number of revolutions)</b> | 14 bit x 12 bit (16,384 x 4,096) |
| <b>Error limits G</b>   | 0.35° (at 20 °C) <sup>1)</sup>   |
| <b>Repeatability standard deviation <math>\sigma_r</math></b>                   | 0.2° (at 20 °C) <sup>2)</sup>    |

<sup>1)</sup> In accordance with DIN ISO 1319-1, position of the upper and lower error limit depends on the installation situation, specified value refers to a symmetrical position, i.e. deviation in upper and lower direction is the same.

<sup>2)</sup> In accordance with DIN ISO 55350-13; 68.3% of the measured values are inside the specified area.

#### Interfaces

|                                       |  |
|---------------------------------------|--|
| <b>Communication interface</b>        | IO-Link  |
| <b>Communication Interface detail</b> | IO-Link V1.1   |
| <b>Initialization time</b>            | 2 s <sup>1)</sup>  |
| <b>Cycle time</b>                     | ≤ 3.2 ms   |
| <b>Smart Sensor</b>                   | Efficient communication, Enhanced Sensing, diagnosis, Smart Task   |
| <b>Process data</b>                   | Position, speed, electronic cams, limit values, linear position, linear speed, errors and warnings, switching signals on pin 2, Length, switching signals on pin 4 |
| <b>Parameterising data</b>            | Number of steps per revolution   |

<sup>1)</sup> Valid positional data can be read once this time has elapsed.

<sup>2)</sup> Between input signal on pin 2 and associated output signal on pin 4.

|   |  |
|---|--|
|   | Number of revolutions<br>PRESET<br>Counting direction<br>Sampling rate for speed calculation<br>Unit for output of the speed value<br>Round axis functionality<br>Electronic cams(2 channels x 8 cams)<br>Limit values<br>Linear measuring length per 360°<br>Pin 2 configuration<br>Configuration of length measurement (IO-Link mode)<br>Configuration of length monitoring (IO-Link and SIO mode)<br>Configuration of trigger after a defined length (SIO mode) |
| <b>Available diagnostics data</b>       | Minimum and maximum temperature<br>Maximum speed<br>Power-on counter<br>Operating hours counter power-on/motion<br>Counter of direction changes/number of movements cw/number of movements ccw<br>Minimum and maximum operating voltage<br>Distance covered<br>Number of trigger signals on pin 2  |
| <b>Status information</b>               | Via status LED   |
| <b>Switching input/Switching output</b> | ✓  |
| <b>Pin 2 input frequency</b>            | ≤ 100 Hz   |
| <b>Output frequency pin 2</b>           | ≤ 100 Hz   |
| <b>Output frequency pin 4</b>           | ≤ 100 Hz   |
| <b>Latency</b>                          | 3.5 ms <sup>2)</sup>   |

<sup>1)</sup> Valid positional data can be read once this time has elapsed.

<sup>2)</sup> Between input signal on pin 2 and associated output signal on pin 4.

## Electronics

|                                    |                                       |
|------------------------------------|---------------------------------------|
| <b>Connection type</b>             | Male connector, M12, 4-pin, universal |
| <b>Supply voltage</b>              | 18 ... 30 V                           |
| <b>Power consumption</b>           | ≤ 1.5 W                               |
| <b>Reverse polarity protection</b> | ✓                                     |

## Mechanics

|                                     |  |
|-------------------------------------|--|
| <b>Mechanical design</b>            | Solid shaft, Servo flange                    |
| <b>Shaft diameter</b>               | 3/8"   |
| <b>Shaft length</b>                 | 12 mm  |
| <b>Characteristics of the shaft</b> | With flat                                    |
| <b>Weight</b>                       | 0.2 kg. Based on devices with male connector |
| <b>Shaft material</b>               | Stainless steel 1,4305                       |
| <b>Flange material</b>              | Stainless steel 1,4305                       |
| <b>Housing material</b>             | Stainless steel 1,4305                       |
| <b>Start up torque</b>              | ≤ 1 Ncm <sup>1)</sup>                        |
| <b>Operating torque</b>             | ≤ 1 Ncm <sup>1)</sup>                        |
| <b>Permissible shaft loading</b>    | 40 N (radial)<br>20 N (axial)                |
| <b>Operating speed</b>              | ≤ 6,000 min <sup>-1</sup>                    |

<sup>1)</sup> At 20 °C.

|                                       |                                   |
|---------------------------------------|-----------------------------------|
| <b>Moment of inertia of the rotor</b> | 2.5 gcm <sup>2</sup>              |
| <b>Bearing lifetime</b>               | 3.6 x 10 <sup>8</sup> revolutions |
| <b>Angular acceleration</b>           | ≤ 500,000 rad/s <sup>2</sup>      |

<sup>1)</sup> At 20 °C.

### Ambient data

|                                      |  |
|--------------------------------------|--|
| <b>EMC</b>                           | According to EN 61000-6-2, EN 61000-6-3 and EN 61131-9 |
| <b>Enclosure rating</b>              | IP67 (IEC 60529)<br>IP69K (IEC 60529)                  |
| <b>Permissible relative humidity</b> | 90 % (Condensation not permitted)                      |
| <b>Operating temperature range</b>   | -40 °C ... +85 °C                                      |
| <b>Storage temperature range</b>     | -40 °C ... +100 °C, Without packaging                  |
| <b>Resistance to shocks</b>          | 100 g, 6 ms (EN 60068-2-27)                            |
| <b>Resistance to vibration</b>       | 20 g, 10 Hz ... 2,000 Hz (EN 60068-2-6)                |

### Smart Task

|                        |                                |
|------------------------|--------------------------------|
| <b>Smart Task name</b> | Length measurement and trigger |
|------------------------|--------------------------------|

### Certificates

|  |   |
|--|---|
| <b>EU declaration of conformity</b>  | ✓ |
| <b>UK declaration of conformity</b>  | ✓ |
| <b>ACMA declaration of conformity</b>  | ✓ |
| <b>Moroccan declaration of conformity</b>                                    | ✓ |
| <b>China RoHS</b>  | ✓ |
| <b>IO-Link certificate</b>   | ✓ |
| <b>cTUVus certificate</b>  | ✓ |
| <b>Information according to Art. 3 of Data Act (Regulation EU 2023/2854)</b> | ✓ |

### Classifications

|                     |          |
|---------------------|----------|
| <b>ECLASS 5.0</b>   | 27270502 |
| <b>ECLASS 5.1.4</b> | 27270502 |
| <b>ECLASS 6.0</b>   | 27270590 |
| <b>ECLASS 6.2</b>   | 27270590 |
| <b>ECLASS 7.0</b>   | 27270502 |
| <b>ECLASS 8.0</b>   | 27270502 |
| <b>ECLASS 8.1</b>   | 27270502 |
| <b>ECLASS 9.0</b>   | 27270502 |
| <b>ECLASS 10.0</b>  | 27270502 |
| <b>ECLASS 11.0</b>  | 27270502 |
| <b>ECLASS 12.0</b>  | 27270502 |
| <b>ETIM 5.0</b>     | EC001486 |
| <b>ETIM 6.0</b>     | EC001486 |
| <b>ETIM 7.0</b>     | EC001486 |
| <b>ETIM 8.0</b>     | EC001486 |

UNSPSC 16.0901

41112113

Dimensional drawing Solid shaft, servo flange, male connector

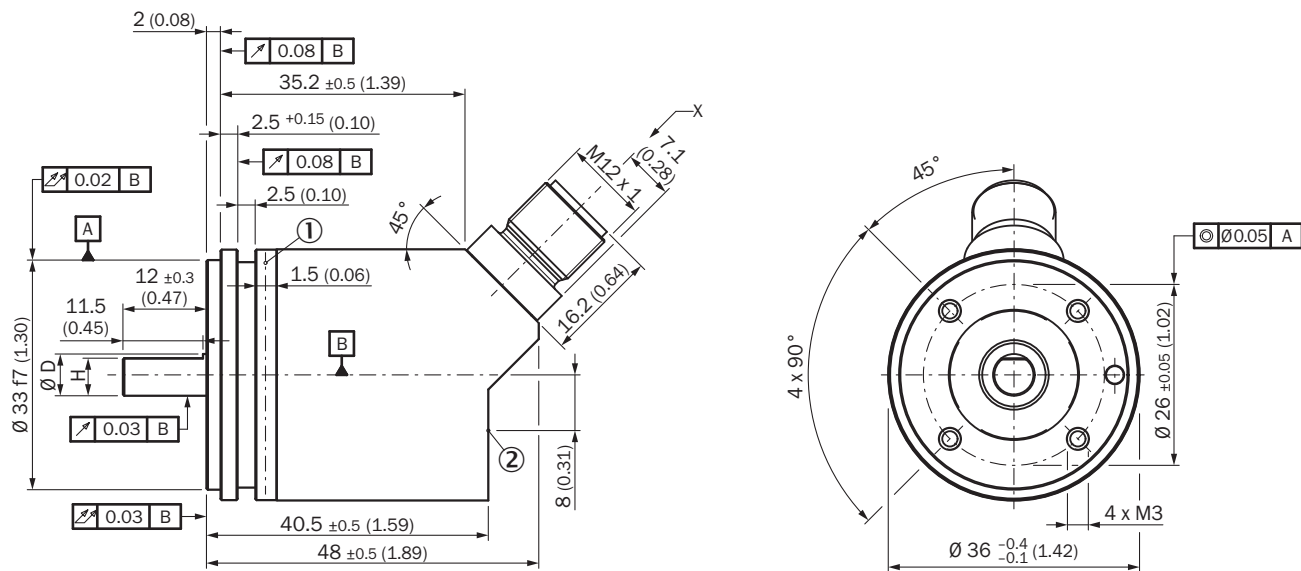

Dimensions in mm (inch)

Non-tolerated dimensions according to DIN-ISO 2768-mk

① Measuring point for operating temperature

② measuring point for vibrations

| Type   | Shaft diameter $\emptyset D$ f7 | B       | H      |
|--|---------------------------------|---------|--------|
| AHx36x-S1xxxxxxx<br>AHx36x-S3xxxxxxx                     | 6 mm                            | 3,6 mm  | 5,4 mm |
| AHx36x-S9xxxxxxx<br>AHx36x-S5xxxxxxx                     | 8 mm                            | 3,9 mm  | 7,5 mm |
| AHx36x-S2xxxxxxx<br>AHx36x-S4xxxxxxx<br>AHx36x-SCxxxxxxx | 10 mm                           | 6 mm    | 9 mm   |
| AHx36x-SAxxxxxxx<br>AHx36x-S8xxxxxxx                     | 1/4"                            | 3,85 mm | 5,7 mm |
| AHx36x-SBxxxxxxx<br>AHx36x-S7xxxxxxx                     | 3/8"                            | 4,35 mm | 9 mm   |

Anschlussbelegung









| PIN | Wire color | Signal | Function                             |   |                             |
|-----|------------|--------|--------------------------------------|---|-----------------------------|
|     |            |        | Basic                                | Advanced  | Advanced Smart Task         |
| -   | -          | -      | Encoder supply voltage 18-30 V (+Us) |   |                             |
| 1   | Brown      | L+     | Encoder supply voltage 18-30 V (+Us) |   |                             |
| 2   | White      | I/Q    | Not connected - no function          | Multifunctional pin (configurable as switching input or switching output) |                             |
| 3   | Blue       | L-     | Encoder supply voltage 0 V (GND)     |   |                             |
| 4   | Black      | C/Q    | IO-Link communication                |   |                             |
|     |            | -      |                                      |   | Switching output (SIO mode) |





Recommended accessories

Other models and accessories → [www.sick.com/AHS\\_AHM36](http://www.sick.com/AHS_AHM36)

|   | Brief description   | Type               | part no. |
|---|---|--------------------|----------|
| connectors and cables   |   |                    |          |
|    | <ul style="list-style-type: none"> <li><b>Description:</b> Sensor/actuator cable, unshielded</li> <li><b>Connection type head A:</b> Female connector, M12, 4-pin, straight</li> <li><b>Connection type head B:</b> Flying leads</li> <li><b>Signal type:</b> Sensor/actuator cable</li> <li><b>Cable:</b> 2 m, 4-wire, PVC</li> <li><b>Connection systems:</b> Flying leads</li> <li><b>Note:</b> This product is generally resistant to chemical cleaning agents (see ECOLAB). Please do not use cleaning agents of any other Kind., Not resistant against lactic acid &amp; hydrogen peroxide (H2O2)</li> <li><b>Application:</b> Untaminated zones, Hygienic and washdown zones, Zones with chemicals</li> </ul>  | YF2AP4-020VB3XLEAX | 6052613  |
|    | <ul style="list-style-type: none"> <li><b>Description:</b> Sensor/actuator cable, unshielded</li> <li><b>Connection type head A:</b> Female connector, M12, 4-pin, angled</li> <li><b>Connection type head B:</b> Flying leads</li> <li><b>Signal type:</b> Sensor/actuator cable</li> <li><b>Cable:</b> 2 m, 4-wire, PVC</li> <li><b>Connection systems:</b> Flying leads</li> <li><b>Note:</b> This product is generally resistant to chemical cleaning agents (see ECOLAB). Please do not use cleaning agents of any other Kind., Not resistant against lactic acid &amp; hydrogen peroxide (H2O2)</li> <li><b>Application:</b> Untaminated zones, Hygienic and washdown zones, Zones with chemicals</li> </ul>    | YG2AP4-020VB3XLEAX | 6052614  |
|    | <ul style="list-style-type: none"> <li><b>Description:</b> Sensor/actuator cable, unshielded</li> <li><b>Connection type head A:</b> Female connector, M12, 4-pin, straight</li> <li><b>Connection type head B:</b> Flying leads</li> <li><b>Signal type:</b> Sensor/actuator cable</li> <li><b>Cable:</b> 5 m, 4-wire, PVC</li> <li><b>Connection systems:</b> Flying leads</li> <li><b>Note:</b> This product is generally resistant to chemical cleaning agents (see ECOLAB). Please do not use cleaning agents of any other Kind., Not resistant against lactic acid &amp; hydrogen peroxide (H2O2)</li> <li><b>Application:</b> Untaminated zones, Hygienic and washdown zones, Zones with chemicals</li> </ul>  | YF2AP4-050VB3XLEAX | 6052615  |
|  | <ul style="list-style-type: none"> <li><b>Description:</b> Sensor/actuator cable, unshielded</li> <li><b>Connection type head A:</b> Female connector, M12, 4-pin, angled</li> <li><b>Connection type head B:</b> Flying leads</li> <li><b>Signal type:</b> Sensor/actuator cable</li> <li><b>Cable:</b> 5 m, 4-wire, PVC</li> <li><b>Connection systems:</b> Flying leads</li> <li><b>Note:</b> This product is generally resistant to chemical cleaning agents (see ECOLAB). Please do not use cleaning agents of any other Kind., Not resistant against lactic acid &amp; hydrogen peroxide (H2O2)</li> <li><b>Application:</b> Untaminated zones, Hygienic and washdown zones, Zones with chemicals</li> </ul>    | YG2AP4-050VB3XLEAX | 6052616  |
|  | <ul style="list-style-type: none"> <li><b>Description:</b> Sensor/actuator cable, unshielded</li> <li><b>Connection type head A:</b> Female connector, M12, 4-pin, straight</li> <li><b>Connection type head B:</b> Flying leads</li> <li><b>Signal type:</b> Sensor/actuator cable</li> <li><b>Cable:</b> 10 m, 4-wire, PVC</li> <li><b>Connection systems:</b> Flying leads</li> <li><b>Note:</b> This product is generally resistant to chemical cleaning agents (see ECOLAB). Please do not use cleaning agents of any other Kind., Not resistant against lactic acid &amp; hydrogen peroxide (H2O2)</li> <li><b>Application:</b> Untaminated zones, Hygienic and washdown zones, Zones with chemicals</li> </ul> | YF2AP4-100VB3XLEAX | 6052617  |
|  | <ul style="list-style-type: none"> <li><b>Description:</b> Sensor/actuator cable, unshielded</li> <li><b>Connection type head A:</b> Female connector, M12, 4-pin, angled</li> <li><b>Connection type head B:</b> Flying leads</li> <li><b>Signal type:</b> Sensor/actuator cable</li> <li><b>Cable:</b> 10 m, 4-wire, PVC</li> <li><b>Connection systems:</b> Flying leads</li> <li><b>Note:</b> This product is generally resistant to chemical cleaning agents (see ECOLAB). Please do not use cleaning agents of any other Kind., Not resistant against lactic acid &amp; hydrogen peroxide (H2O2)</li> <li><b>Application:</b> Untaminated zones, Hygienic and washdown zones, Zones with chemicals</li> </ul>   | YG2AP4-100VB3XLEAX | 6052618  |
|  | <ul style="list-style-type: none"> <li><b>Description:</b> Sensor/actuator cable, unshielded</li> <li><b>Connection type head A:</b> Female connector, M12, 4-pin, straight</li> <li><b>Connection type head B:</b> Male connector, M12, 4-pin, straight</li> <li><b>Signal type:</b> Sensor/actuator cable</li> <li><b>Cable:</b> 2 m, 4-wire, PVC</li> </ul>  | YM2AP4-020VB3F2AP4 | 6052630  |

|   | Brief description  | Type               | part no. |
|---|--|--------------------|----------|
|    | <ul style="list-style-type: none"> <li><b>Note:</b> This product is generally resistant to chemical cleaning agents (see ECOLAB). Please do not use cleaning agents of any other Kind., Not resistant against lactic acid &amp; hydrogen peroxide (H2O2)</li> <li><b>Application:</b> Uncontaminated zones, Hygienic and washdown zones, Zones with chemicals</li> <li><b>Description:</b> Sensor/actuator cable, unshielded</li> <li><b>Connection type head A:</b> Female connector, M12, 4-pin, straight</li> <li><b>Connection type head B:</b> Male connector, M12, 4-pin, straight</li> <li><b>Signal type:</b> Sensor/actuator cable</li> <li><b>Cable:</b> 5 m, 4-wire, PVC</li> <li><b>Note:</b> This product is generally resistant to chemical cleaning agents (see ECOLAB). Please do not use cleaning agents of any other Kind., Not resistant against lactic acid &amp; hydrogen peroxide (H2O2)</li> <li><b>Application:</b> Uncontaminated zones, Hygienic and washdown zones, Zones with chemicals</li> </ul> | YM2AP4-050VB3F2AP4 | 6052631  |
|    | <ul style="list-style-type: none"> <li><b>Description:</b> Sensor/actuator cable, unshielded</li> <li><b>Connection type head A:</b> Female connector, M12, 4-pin, angled</li> <li><b>Connection type head B:</b> Male connector, M12, 4-pin, straight</li> <li><b>Signal type:</b> Sensor/actuator cable</li> <li><b>Cable:</b> 2 m, 4-wire, PVC</li> <li><b>Note:</b> This product is generally resistant to chemical cleaning agents (see ECOLAB). Please do not use cleaning agents of any other Kind., Not resistant against lactic acid &amp; hydrogen peroxide (H2O2)</li> <li><b>Application:</b> Uncontaminated zones, Hygienic and washdown zones, Zones with chemicals</li> </ul>   | YM2AP4-020VB3G2AP4 | 6052633  |
|    | <ul style="list-style-type: none"> <li><b>Description:</b> Sensor/actuator cable, unshielded</li> <li><b>Connection type head A:</b> Female connector, M12, 4-pin, angled</li> <li><b>Connection type head B:</b> Male connector, M12, 4-pin, straight</li> <li><b>Signal type:</b> Sensor/actuator cable</li> <li><b>Cable:</b> 5 m, 4-wire, PVC</li> <li><b>Note:</b> This product is generally resistant to chemical cleaning agents (see ECOLAB). Please do not use cleaning agents of any other Kind., Not resistant against lactic acid &amp; hydrogen peroxide (H2O2)</li> <li><b>Application:</b> Uncontaminated zones, Hygienic and washdown zones, Zones with chemicals</li> </ul>   | YM2AP4-050VB3G2AP4 | 6052634  |
|   | <ul style="list-style-type: none"> <li><b>Description:</b> Sensor/actuator cable, unshielded</li> <li><b>Connection type head A:</b> Female connector, M12, 4-pin, straight</li> <li><b>Connection type head B:</b> Flying leads</li> <li><b>Signal type:</b> Sensor/actuator cable</li> <li><b>Cable:</b> 2 m, 4-wire, PP</li> <li><b>Connection systems:</b> Flying leads</li> <li><b>Note:</b> This product is generally resistant to chemical cleaning agents (see ECOLAB) and other chemical compounds such as H2O2 and CH2O2. Before permanent installation is carried out, the material's resistance to the cleaning agent being used must be checked., Resistant against lactic acid &amp; hydrogen peroxide (H2O2)</li> <li><b>Application:</b> Hygienic and washdown zones, Drag chain operation, Robot, cold bending resistant, seawater resistant</li> </ul>   | DOL-1204-G02MRN    | 6058291  |
|  | <ul style="list-style-type: none"> <li><b>Description:</b> Sensor/actuator cable, unshielded</li> <li><b>Connection type head A:</b> Female connector, M12, 4-pin, angled</li> <li><b>Connection type head B:</b> Flying leads</li> <li><b>Signal type:</b> Sensor/actuator cable</li> <li><b>Cable:</b> 2 m, 4-wire, PP</li> <li><b>Connection systems:</b> Flying leads</li> <li><b>Note:</b> This product is generally resistant to chemical cleaning agents (see ECOLAB) and other chemical compounds such as H2O2 and CH2O2. Before permanent installation is carried out, the material's resistance to the cleaning agent being used must be checked., Resistant against lactic acid &amp; hydrogen peroxide (H2O2)</li> <li><b>Application:</b> Hygienic and washdown zones, Drag chain operation, Robot, cold bending resistant, seawater resistant</li> </ul>   | DOL-1204-W02MRN    | 6058474  |
|  | <ul style="list-style-type: none"> <li><b>Description:</b> Sensor/actuator cable, unshielded</li> <li><b>Connection type head A:</b> Female connector, M12, 4-pin, straight</li> <li><b>Connection type head B:</b> Flying leads</li> <li><b>Signal type:</b> Sensor/actuator cable</li> <li><b>Cable:</b> 5 m, 4-wire, PP</li> <li><b>Connection systems:</b> Flying leads</li> <li><b>Note:</b> This product is generally resistant to chemical cleaning agents (see ECOLAB) and other chemical compounds such as H2O2 and CH2O2. Before permanent installation is carried out, the material's resistance to the cleaning agent being used must be checked., Resistant against lactic acid &amp; hydrogen peroxide (H2O2)</li> <li><b>Application:</b> Hygienic and washdown zones, Drag chain operation, Robot, cold bending resistant, seawater resistant</li> </ul>   | DOL-1204-G05MRN    | 6058476  |
|  | <ul style="list-style-type: none"> <li><b>Description:</b> Sensor/actuator cable, unshielded</li> <li><b>Connection type head A:</b> Female connector, M12, 4-pin, angled</li> <li><b>Connection type head B:</b> Flying leads</li> <li><b>Signal type:</b> Sensor/actuator cable</li> <li><b>Cable:</b> 5 m, 4-wire, PP</li> </ul>  | DOL-1204-W05MRN    | 6058477  |

|   | Brief description   | Type            | part no. |
|---|---|-----------------|----------|
|   | <ul style="list-style-type: none"> <li>• <b>Connection systems:</b> Flying leads</li> <li>• <b>Note:</b> This product is generally resistant to chemical cleaning agents (see ECOLAB) and other chemical compounds such as H2O2 and CH2O2. Before permanent installation is carried out, the material's resistance to the cleaning agent being used must be checked., Resistant against lactic acid &amp; hydrogen peroxide (H2O2)</li> <li>• <b>Application:</b> Hygienic and washdown zones, Drag chain operation, Robot, cold bending resistant, seawater resistant</li> </ul>   |                 |          |
|    | <ul style="list-style-type: none"> <li>• <b>Description:</b> Sensor/actuator cable, unshielded</li> <li>• <b>Connection type head A:</b> Female connector, M12, 4-pin, straight</li> <li>• <b>Connection type head B:</b> Flying leads</li> <li>• <b>Signal type:</b> Sensor/actuator cable</li> <li>• <b>Cable:</b> 10 m, 4-wire, PP</li> <li>• <b>Connection systems:</b> Flying leads</li> <li>• <b>Note:</b> This product is generally resistant to chemical cleaning agents (see ECOLAB) and other chemical compounds such as H2O2 and CH2O2. Before permanent installation is carried out, the material's resistance to the cleaning agent being used must be checked., Resistant against lactic acid &amp; hydrogen peroxide (H2O2)</li> <li>• <b>Application:</b> Hygienic and washdown zones, Drag chain operation, Robot, cold bending resistant, seawater resistant</li> </ul> | DOL-1204-G10MRN | 6058478  |
|    | <ul style="list-style-type: none"> <li>• <b>Description:</b> Sensor/actuator cable, unshielded</li> <li>• <b>Connection type head A:</b> Female connector, M12, 4-pin, angled</li> <li>• <b>Connection type head B:</b> Flying leads</li> <li>• <b>Signal type:</b> Sensor/actuator cable</li> <li>• <b>Cable:</b> 10 m, 4-wire, PP</li> <li>• <b>Connection systems:</b> Flying leads</li> <li>• <b>Note:</b> This product is generally resistant to chemical cleaning agents (see ECOLAB) and other chemical compounds such as H2O2 and CH2O2. Before permanent installation is carried out, the material's resistance to the cleaning agent being used must be checked., Resistant against lactic acid &amp; hydrogen peroxide (H2O2)</li> <li>• <b>Application:</b> Hygienic and washdown zones, Drag chain operation, Robot, cold bending resistant, seawater resistant</li> </ul>   | DOL-1204-W10MRN | 6058479  |
|   | <ul style="list-style-type: none"> <li>• <b>Description:</b> Sensor/actuator cable, unshielded</li> <li>• <b>Connection type head A:</b> Female connector, M12, 4-pin, straight</li> <li>• <b>Connection type head B:</b> Male connector, M12, 4-pin, straight</li> <li>• <b>Signal type:</b> Sensor/actuator cable</li> <li>• <b>Cable:</b> 2 m, 4-wire, PP</li> <li>• <b>Note:</b> This product is generally resistant to chemical cleaning agents (see ECOLAB) and other chemical compounds such as H2O2 and CH2O2. Before permanent installation is carried out, the material's resistance to the cleaning agent being used must be checked., Resistant against lactic acid &amp; hydrogen peroxide (H2O2)</li> <li>• <b>Application:</b> Hygienic and washdown zones, Drag chain operation, Robot, cold bending resistant, seawater resistant</li> </ul>                             | DSL-1204-G02MRN | 6058499  |
|  | <ul style="list-style-type: none"> <li>• <b>Description:</b> Sensor/actuator cable, unshielded</li> <li>• <b>Connection type head A:</b> Female connector, M12, 4-pin, straight</li> <li>• <b>Connection type head B:</b> Male connector, M12, 4-pin, straight</li> <li>• <b>Signal type:</b> Sensor/actuator cable</li> <li>• <b>Cable:</b> 5 m, 4-wire, PP</li> <li>• <b>Note:</b> This product is generally resistant to chemical cleaning agents (see ECOLAB) and other chemical compounds such as H2O2 and CH2O2. Before permanent installation is carried out, the material's resistance to the cleaning agent being used must be checked., Resistant against lactic acid &amp; hydrogen peroxide (H2O2)</li> <li>• <b>Application:</b> Hygienic and washdown zones, Drag chain operation, Robot, cold bending resistant, seawater resistant</li> </ul>                             | DSL-1204-G05MRN | 6058500  |
|  | <ul style="list-style-type: none"> <li>• <b>Description:</b> Sensor/actuator cable, unshielded</li> <li>• <b>Connection type head A:</b> Female connector, M12, 4-pin, angled</li> <li>• <b>Connection type head B:</b> Male connector, M12, 4-pin, straight</li> <li>• <b>Signal type:</b> Sensor/actuator cable</li> <li>• <b>Cable:</b> 2 m, 4-wire, PP</li> <li>• <b>Note:</b> This product is generally resistant to chemical cleaning agents (see ECOLAB) and other chemical compounds such as H2O2 and CH2O2. Before permanent installation is carried out, the material's resistance to the cleaning agent being used must be checked., Resistant against lactic acid &amp; hydrogen peroxide (H2O2)</li> <li>• <b>Application:</b> Hygienic and washdown zones, Drag chain operation, Robot, cold bending resistant, seawater resistant</li> </ul>                               | DSL-1204-B02MRN | 6058502  |
|  | <ul style="list-style-type: none"> <li>• <b>Description:</b> Sensor/actuator cable, unshielded</li> <li>• <b>Connection type head A:</b> Female connector, M12, 4-pin, angled</li> <li>• <b>Connection type head B:</b> Male connector, M12, 4-pin, straight</li> <li>• <b>Signal type:</b> Sensor/actuator cable</li> <li>• <b>Cable:</b> 5 m, 4-wire, PP</li> <li>• <b>Note:</b> This product is generally resistant to chemical cleaning agents (see ECOLAB) and other chemical compounds such as H2O2 and CH2O2. Before permanent installation is carried out, the material's resistance to the cleaning agent being used must be checked., Resistant against lactic acid &amp; hydrogen peroxide (H2O2)</li> </ul>   | DSL-1204-B05MRN | 6058503  |

|   | Brief description   | Type               | part no. |
|---|---|--------------------|----------|
|   | <ul style="list-style-type: none"> <li><b>Application:</b> Hygienic and washdown zones, Drag chain operation, Robot, cold bending resistant, seawater resistant</li> </ul>  |                    |          |
|    | <ul style="list-style-type: none"> <li><b>Description:</b> Sensor/actuator cable, unshielded</li> <li><b>Connection type head A:</b> Female connector, M12, 4-pin, straight</li> <li><b>Connection type head B:</b> Male connector, M12, 4-pin, straight</li> <li><b>Signal type:</b> Sensor/actuator cable</li> <li><b>Cable:</b> 20 m, 4-wire, PP</li> <li><b>Note:</b> This product is generally resistant to chemical cleaning agents (see ECOLAB) and other chemical compounds such as H2O2 and CH2O2. Before permanent installation is carried out, the material's resistance to the cleaning agent being used must be checked., Resistant against lactic acid &amp; hydrogen peroxide (H2O2)</li> <li><b>Application:</b> Hygienic and washdown zones, Drag chain operation, Robot, cold bending resistant, seawater resistant</li> </ul>                          | YF2AP4-020PA2M2AP4 | 2143765  |
|    | <ul style="list-style-type: none"> <li><b>Description:</b> Sensor/actuator cable, unshielded</li> <li><b>Connection type head A:</b> Female connector, M12, 4-pin, straight</li> <li><b>Connection type head B:</b> Flying leads</li> <li><b>Signal type:</b> Sensor/actuator cable</li> <li><b>Cable:</b> 30 m, 4-wire, PP</li> <li><b>Connection systems:</b> Flying leads</li> <li><b>Note:</b> This product is generally resistant to chemical cleaning agents (see ECOLAB) and other chemical compounds such as H2O2 and CH2O2. Before permanent installation is carried out, the material's resistance to the cleaning agent being used must be checked., Resistant against lactic acid &amp; hydrogen peroxide (H2O2)</li> <li><b>Application:</b> Hygienic and washdown zones, Drag chain operation, Robot, cold bending resistant, seawater resistant</li> </ul> | YF2AP4-300PA2XLEAX | 2146867  |
|    | <ul style="list-style-type: none"> <li><b>Description:</b> Sensor/actuator cable, unshielded</li> <li><b>Connection type head A:</b> Female connector, M12, 4-pin, angled</li> <li><b>Connection type head B:</b> Male connector, M12, 4-pin, straight</li> <li><b>Signal type:</b> Sensor/actuator cable</li> <li><b>Cable:</b> 3 m, 4-wire, PP</li> <li><b>Note:</b> This product is generally resistant to chemical cleaning agents (see ECOLAB) and other chemical compounds such as H2O2 and CH2O2. Before permanent installation is carried out, the material's resistance to the cleaning agent being used must be checked., Resistant against lactic acid &amp; hydrogen peroxide (H2O2)</li> <li><b>Application:</b> Hygienic and washdown zones, Drag chain operation</li> </ul>  | YG2AP4-030PA2M2AP4 | 2151191  |
|  | <ul style="list-style-type: none"> <li><b>Description:</b> Unshielded</li> <li><b>Connection type head A:</b> Male connector, M12, 4-pin, A-coded</li> <li><b>Connection type head B:</b> Female connector, M12, 4-pin, A-coded</li> <li><b>Connection type head C:</b> Female connector, M12, 4-pin, A-coded</li> <li><b>Cable:</b> 0.11 m, PVC</li> </ul>   | SYL-1204-G0M11-X1  | 6055011  |
| <b>Mounting systems</b>   |   |                    |          |
|  | <ul style="list-style-type: none"> <li><b>Description:</b> Servo clamps, small, for servo flange (clamps, eccentric fastener), 3 pcs, without mounting material</li> <li><b>Items supplied:</b> Without mounting hardware</li> </ul>  | BEF-WK-RESOL       | 2039082  |

## SICK AT A GLANCE

SICK is one of the leading manufacturers of intelligent sensors and sensor solutions for industrial applications. A unique range of products and services creates the perfect basis for controlling processes securely and efficiently, protecting individuals from accidents and preventing damage to the environment.

We have extensive experience in a wide range of industries and understand their processes and requirements. With intelligent sensors, we can deliver exactly what our customers need. In application centers in Europe, Asia and North America, system solutions are tested and optimized in accordance with customer specifications. All this makes us a reliable supplier and development partner.

Comprehensive services complete our offering: SICK LifeTime Services provide support throughout the machine life cycle and ensure safety and productivity.

For us, that is “Sensor Intelligence.”

## WORLDWIDE PRESENCE:

Contacts and other locations –[www.sick.com](http://www.sick.com)