



AHM36I-S1QC000A30

AHS/AHM36

ABSOLUTE ENCODERS

SICK
Sensor Intelligence.



Illustration may differ



Ordering information

Type	part no.
AHM36I-S1QC000A30	1109439

Other models and accessories → www.sick.com/AHS_AHM36

Detailed technical data

Safety-related parameters

MTTF_D (mean time to dangerous failure)	240 years (EN ISO 13849-1)
--	----------------------------

Performance

Number of steps per revolution (max. resolution)	16,384 (14 bit)
Number of revolutions	4,096 (12 bit)
Max. resolution (number of steps per revolution x number of revolutions)	14 bit x 12 bit (16,384 x 4,096)
Error limits G	0.35° (at 20 °C) ¹⁾
Repeatability standard deviation σ_r	0.2° (at 20 °C) ²⁾

¹⁾ In accordance with DIN ISO 1319-1, position of the upper and lower error limit depends on the installation situation, specified value refers to a symmetrical position, i.e. deviation in upper and lower direction is the same.

²⁾ In accordance with DIN ISO 55350-13; 68.3% of the measured values are inside the specified area.

Interfaces

Communication interface	IO-Link
Communication Interface detail	IO-Link V1.1
Initialization time	2 s ¹⁾
Cycle time	≤ 3.2 ms
Smart Sensor	Efficient communication, Enhanced Sensing, diagnosis, Smart Task
Process data	Position, speed, electronic cams, limit values, linear position, linear speed, errors and warnings, switching signals on pin 2, Length, switching signals on pin 4
Parameterising data	Number of steps per revolution

¹⁾ Valid positional data can be read once this time has elapsed.

²⁾ Between input signal on pin 2 and associated output signal on pin 4.

	Number of revolutions PRESET Counting direction Sampling rate for speed calculation Unit for output of the speed value Round axis functionality Electronic cams(2 channels x 8 cams) Limit values Linear measuring length per 360° Pin 2 configuration Configuration of length measurement (IO-Link mode) Configuration of length monitoring (IO-Link and SIO mode) Configuration of trigger after a defined length (SIO mode)
Available diagnostics data	Minimum and maximum temperature Maximum speed Power-on counter Operating hours counter power-on/motion Counter of direction changes/number of movements cw/number of movements ccw Minimum and maximum operating voltage Distance covered Number of trigger signals on pin 2
Status information	Via status LED
Switching input/Switching output	✓
Pin 2 input frequency	≤ 100 Hz
Output frequency pin 2	≤ 100 Hz
Output frequency pin 4	≤ 100 Hz
Latency	3.5 ms ²⁾

¹⁾ Valid positional data can be read once this time has elapsed.

²⁾ Between input signal on pin 2 and associated output signal on pin 4.

Electronics

Connection type	Male connector, M12, 4-pin, universal
Supply voltage	18 ... 30 V
Power consumption	≤ 1.5 W
Reverse polarity protection	✓

Mechanics

Mechanical design	Solid shaft, Servo flange
Shaft diameter	6 mm
Shaft length	12 mm
Characteristics of the shaft	With flat
Weight	0.2 kg. Based on devices with male connector
Shaft material	Stainless steel 1,4305
Flange material	Stainless steel 1,4305
Housing material	Stainless steel 1,4305
Start up torque	≤ 1 Ncm ¹⁾
Operating torque	≤ 1 Ncm ¹⁾
Permissible shaft loading	40 N (radial) 20 N (axial)
Operating speed	≤ 6,000 min ⁻¹

¹⁾ At 20 °C.

Moment of inertia of the rotor	2.5 gcm ²
Bearing lifetime	3.6 x 10 ⁸ revolutions
Angular acceleration	≤ 500,000 rad/s ²

¹⁾ At 20 °C.

Ambient data

EMC	According to EN 61000-6-2, EN 61000-6-3 and EN 61131-9
Enclosure rating	IP67 (IEC 60529) IP69K (IEC 60529)
Permissible relative humidity	90 % (Condensation not permitted)
Operating temperature range	-40 °C ... +85 °C
Storage temperature range	-40 °C ... +100 °C, Without packaging
Resistance to shocks	100 g, 6 ms (EN 60068-2-27)
Resistance to vibration	20 g, 10 Hz ... 2,000 Hz (EN 60068-2-6)

Smart Task

Smart Task name	Length measurement and trigger
------------------------	--------------------------------

Certificates

EU declaration of conformity	✓
UK declaration of conformity	✓
ACMA declaration of conformity	✓
Moroccan declaration of conformity	✓
China RoHS	✓
IO-Link certificate	✓
cTUVus certificate	✓
Information according to Art. 3 of Data Act (Regulation EU 2023/2854)	✓

Classifications

ECLASS 5.0	27270502
ECLASS 5.1.4	27270502
ECLASS 6.0	27270590
ECLASS 6.2	27270590
ECLASS 7.0	27270502
ECLASS 8.0	27270502
ECLASS 8.1	27270502
ECLASS 9.0	27270502
ECLASS 10.0	27270502
ECLASS 11.0	27270502
ECLASS 12.0	27270502
ETIM 5.0	EC001486
ETIM 6.0	EC001486
ETIM 7.0	EC001486
ETIM 8.0	EC001486

UNSPSC 16.0901

41112113

Dimensional drawing Solid shaft, servo flange, male connector

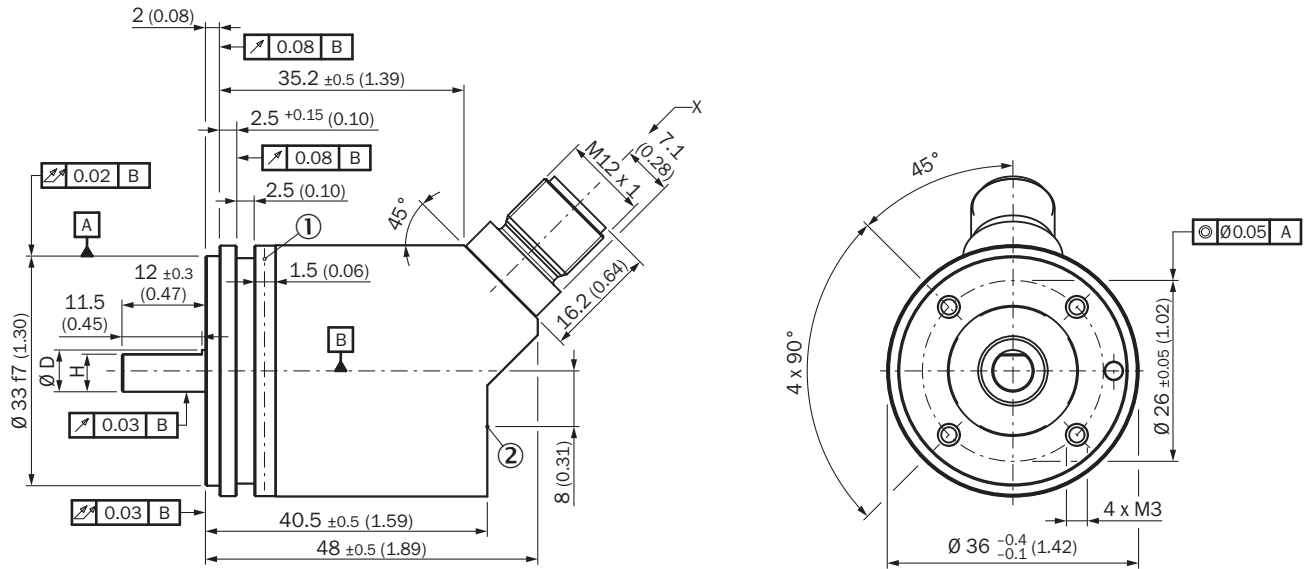

Dimensions in mm (inch)

Non-tolerated dimensions according to DIN-ISO 2768-mk

① Measuring point for operating temperature

② measuring point for vibrations

Type	Shaft diameter Ø D f7	B	H
AHx36x-S1xxxxxxxx AHx36x-S3xxxxxxxx	6 mm	3,6 mm	5,4 mm
AHx36x-S9xxxxxxxx AHx36x-S5xxxxxxxx	8 mm	3,9 mm	7,5 mm
AHx36x-S2xxxxxxxx AHx36x-S4xxxxxxxx AHx36x-SCxxxxxxxx	10 mm	6 mm	9 mm
AHx36x-SAxxxxxxxx AHx36x-S8xxxxxxxx	1/4"	3,85 mm	5,7 mm
AHx36x-SBxxxxxxxx AHx36x-S7xxxxxxxx	3/8"	4,35 mm	9 mm

Anschlussbelegung









PIN	Wire color	Signal	Function		
			Basic	Advanced	Advanced Smart Task
-	-	-	Encoder supply voltage 18-30 V (+Us)		
1	Brown	L+	Encoder supply voltage 18-30 V (+Us)		
2	White	I/Q	Not connected - no function	Multifunctional pin (configurable as switching input or switching output)	
3	Blue	L-	Encoder supply voltage 0 V (GND)		
4	Black	C/Q	IO-Link communication		
		-			Switching output (SIO mode)





Recommended accessories





Other models and accessories → www.sick.com/AHS_AHM36

	Brief description	Type	part no.
connectors and cables			
	<ul style="list-style-type: none"> Description: Sensor/actuator cable, unshielded Connection type head A: Female connector, M12, 4-pin, straight Connection type head B: Flying leads Signal type: Sensor/actuator cable Cable: 2 m, 4-wire, PVC Connection systems: Flying leads Note: This product is generally resistant to chemical cleaning agents (see ECOLAB). Please do not use cleaning agents of any other Kind., Not resistant against lactic acid & hydrogen peroxide (H2O2) Application: Untaminated zones, Hygienic and washdown zones, Zones with chemicals 	YF2AP4-020VB3XLEAX	6052613
	<ul style="list-style-type: none"> Description: Sensor/actuator cable, unshielded Connection type head A: Female connector, M12, 4-pin, angled Connection type head B: Flying leads Signal type: Sensor/actuator cable Cable: 2 m, 4-wire, PVC Connection systems: Flying leads Note: This product is generally resistant to chemical cleaning agents (see ECOLAB). Please do not use cleaning agents of any other Kind., Not resistant against lactic acid & hydrogen peroxide (H2O2) Application: Untaminated zones, Hygienic and washdown zones, Zones with chemicals 	YG2AP4-020VB3XLEAX	6052614
	<ul style="list-style-type: none"> Description: Sensor/actuator cable, unshielded Connection type head A: Female connector, M12, 4-pin, straight Connection type head B: Flying leads Signal type: Sensor/actuator cable Cable: 5 m, 4-wire, PVC Connection systems: Flying leads Note: This product is generally resistant to chemical cleaning agents (see ECOLAB). Please do not use cleaning agents of any other Kind., Not resistant against lactic acid & hydrogen peroxide (H2O2) Application: Untaminated zones, Hygienic and washdown zones, Zones with chemicals 	YF2AP4-050VB3XLEAX	6052615
	<ul style="list-style-type: none"> Description: Sensor/actuator cable, unshielded Connection type head A: Female connector, M12, 4-pin, angled Connection type head B: Flying leads Signal type: Sensor/actuator cable Cable: 5 m, 4-wire, PVC Connection systems: Flying leads Note: This product is generally resistant to chemical cleaning agents (see ECOLAB). Please do not use cleaning agents of any other Kind., Not resistant against lactic acid & hydrogen peroxide (H2O2) Application: Untaminated zones, Hygienic and washdown zones, Zones with chemicals 	YG2AP4-050VB3XLEAX	6052616
	<ul style="list-style-type: none"> Description: Sensor/actuator cable, unshielded Connection type head A: Female connector, M12, 4-pin, straight Connection type head B: Flying leads Signal type: Sensor/actuator cable Cable: 10 m, 4-wire, PVC Connection systems: Flying leads Note: This product is generally resistant to chemical cleaning agents (see ECOLAB). Please do not use cleaning agents of any other Kind., Not resistant against lactic acid & hydrogen peroxide (H2O2) Application: Untaminated zones, Hygienic and washdown zones, Zones with chemicals 	YF2AP4-100VB3XLEAX	6052617
	<ul style="list-style-type: none"> Description: Sensor/actuator cable, unshielded Connection type head A: Female connector, M12, 4-pin, angled Connection type head B: Flying leads Signal type: Sensor/actuator cable Cable: 10 m, 4-wire, PVC Connection systems: Flying leads Note: This product is generally resistant to chemical cleaning agents (see ECOLAB). Please do not use cleaning agents of any other Kind., Not resistant against lactic acid & hydrogen peroxide (H2O2) Application: Untaminated zones, Hygienic and washdown zones, Zones with chemicals 	YG2AP4-100VB3XLEAX	6052618
	<ul style="list-style-type: none"> Description: Sensor/actuator cable, unshielded Connection type head A: Female connector, M12, 4-pin, straight Connection type head B: Male connector, M12, 4-pin, straight Signal type: Sensor/actuator cable Cable: 2 m, 4-wire, PVC 	YM2AP4-020VB3F2AP4	6052630

	Brief description	Type	part no.
	<ul style="list-style-type: none"> Note: This product is generally resistant to chemical cleaning agents (see ECOLAB). Please do not use cleaning agents of any other Kind., Not resistant against lactic acid & hydrogen peroxide (H2O2) Application: Uncontaminated zones, Hygienic and washdown zones, Zones with chemicals Description: Sensor/actuator cable, unshielded Connection type head A: Female connector, M12, 4-pin, straight Connection type head B: Male connector, M12, 4-pin, straight Signal type: Sensor/actuator cable Cable: 5 m, 4-wire, PVC Note: This product is generally resistant to chemical cleaning agents (see ECOLAB). Please do not use cleaning agents of any other Kind., Not resistant against lactic acid & hydrogen peroxide (H2O2) Application: Uncontaminated zones, Hygienic and washdown zones, Zones with chemicals 	YM2AP4-050VB3F2AP4	6052631
	<ul style="list-style-type: none"> Description: Sensor/actuator cable, unshielded Connection type head A: Female connector, M12, 4-pin, angled Connection type head B: Male connector, M12, 4-pin, straight Signal type: Sensor/actuator cable Cable: 2 m, 4-wire, PVC Note: This product is generally resistant to chemical cleaning agents (see ECOLAB). Please do not use cleaning agents of any other Kind., Not resistant against lactic acid & hydrogen peroxide (H2O2) Application: Uncontaminated zones, Hygienic and washdown zones, Zones with chemicals 	YM2AP4-020VB3G2AP4	6052633
	<ul style="list-style-type: none"> Description: Sensor/actuator cable, unshielded Connection type head A: Female connector, M12, 4-pin, angled Connection type head B: Male connector, M12, 4-pin, straight Signal type: Sensor/actuator cable Cable: 5 m, 4-wire, PVC Note: This product is generally resistant to chemical cleaning agents (see ECOLAB). Please do not use cleaning agents of any other Kind., Not resistant against lactic acid & hydrogen peroxide (H2O2) Application: Uncontaminated zones, Hygienic and washdown zones, Zones with chemicals 	YM2AP4-050VB3G2AP4	6052634
	<ul style="list-style-type: none"> Description: Sensor/actuator cable, unshielded Connection type head A: Female connector, M12, 4-pin, straight Connection type head B: Flying leads Signal type: Sensor/actuator cable Cable: 2 m, 4-wire, PP Connection systems: Flying leads Note: This product is generally resistant to chemical cleaning agents (see ECOLAB) and other chemical compounds such as H2O2 and CH2O2. Before permanent installation is carried out, the material's resistance to the cleaning agent being used must be checked., Resistant against lactic acid & hydrogen peroxide (H2O2) Application: Hygienic and washdown zones, Drag chain operation, Robot, cold bending resistant, seawater resistant 	DOL-1204-G02MRN	6058291
	<ul style="list-style-type: none"> Description: Sensor/actuator cable, unshielded Connection type head A: Female connector, M12, 4-pin, angled Connection type head B: Flying leads Signal type: Sensor/actuator cable Cable: 2 m, 4-wire, PP Connection systems: Flying leads Note: This product is generally resistant to chemical cleaning agents (see ECOLAB) and other chemical compounds such as H2O2 and CH2O2. Before permanent installation is carried out, the material's resistance to the cleaning agent being used must be checked., Resistant against lactic acid & hydrogen peroxide (H2O2) Application: Hygienic and washdown zones, Drag chain operation, Robot, cold bending resistant, seawater resistant 	DOL-1204-W02MRN	6058474
	<ul style="list-style-type: none"> Description: Sensor/actuator cable, unshielded Connection type head A: Female connector, M12, 4-pin, straight Connection type head B: Flying leads Signal type: Sensor/actuator cable Cable: 5 m, 4-wire, PP Connection systems: Flying leads Note: This product is generally resistant to chemical cleaning agents (see ECOLAB) and other chemical compounds such as H2O2 and CH2O2. Before permanent installation is carried out, the material's resistance to the cleaning agent being used must be checked., Resistant against lactic acid & hydrogen peroxide (H2O2) Application: Hygienic and washdown zones, Drag chain operation, Robot, cold bending resistant, seawater resistant 	DOL-1204-G05MRN	6058476
	<ul style="list-style-type: none"> Description: Sensor/actuator cable, unshielded Connection type head A: Female connector, M12, 4-pin, angled Connection type head B: Flying leads Signal type: Sensor/actuator cable Cable: 5 m, 4-wire, PP 	DOL-1204-W05MRN	6058477

	Brief description	Type	part no.
	<ul style="list-style-type: none"> • Connection systems: Flying leads • Note: This product is generally resistant to chemical cleaning agents (see ECOLAB) and other chemical compounds such as H2O2 and CH2O2. Before permanent installation is carried out, the material's resistance to the cleaning agent being used must be checked., Resistant against lactic acid & hydrogen peroxide (H2O2) • Application: Hygienic and washdown zones, Drag chain operation, Robot, cold bending resistant, seawater resistant 		
	<ul style="list-style-type: none"> • Description: Sensor/actuator cable, unshielded • Connection type head A: Female connector, M12, 4-pin, straight • Connection type head B: Flying leads • Signal type: Sensor/actuator cable • Cable: 10 m, 4-wire, PP • Connection systems: Flying leads • Note: This product is generally resistant to chemical cleaning agents (see ECOLAB) and other chemical compounds such as H2O2 and CH2O2. Before permanent installation is carried out, the material's resistance to the cleaning agent being used must be checked., Resistant against lactic acid & hydrogen peroxide (H2O2) • Application: Hygienic and washdown zones, Drag chain operation, Robot, cold bending resistant, seawater resistant 	DOL-1204-G10MRN	6058478
	<ul style="list-style-type: none"> • Description: Sensor/actuator cable, unshielded • Connection type head A: Female connector, M12, 4-pin, angled • Connection type head B: Flying leads • Signal type: Sensor/actuator cable • Cable: 10 m, 4-wire, PP • Connection systems: Flying leads • Note: This product is generally resistant to chemical cleaning agents (see ECOLAB) and other chemical compounds such as H2O2 and CH2O2. Before permanent installation is carried out, the material's resistance to the cleaning agent being used must be checked., Resistant against lactic acid & hydrogen peroxide (H2O2) • Application: Hygienic and washdown zones, Drag chain operation, Robot, cold bending resistant, seawater resistant 	DOL-1204-W10MRN	6058479
	<ul style="list-style-type: none"> • Description: Sensor/actuator cable, unshielded • Connection type head A: Female connector, M12, 4-pin, straight • Connection type head B: Male connector, M12, 4-pin, straight • Signal type: Sensor/actuator cable • Cable: 2 m, 4-wire, PP • Note: This product is generally resistant to chemical cleaning agents (see ECOLAB) and other chemical compounds such as H2O2 and CH2O2. Before permanent installation is carried out, the material's resistance to the cleaning agent being used must be checked., Resistant against lactic acid & hydrogen peroxide (H2O2) • Application: Hygienic and washdown zones, Drag chain operation, Robot, cold bending resistant, seawater resistant 	DSL-1204-G02MRN	6058499
	<ul style="list-style-type: none"> • Description: Sensor/actuator cable, unshielded • Connection type head A: Female connector, M12, 4-pin, straight • Connection type head B: Male connector, M12, 4-pin, straight • Signal type: Sensor/actuator cable • Cable: 5 m, 4-wire, PP • Note: This product is generally resistant to chemical cleaning agents (see ECOLAB) and other chemical compounds such as H2O2 and CH2O2. Before permanent installation is carried out, the material's resistance to the cleaning agent being used must be checked., Resistant against lactic acid & hydrogen peroxide (H2O2) • Application: Hygienic and washdown zones, Drag chain operation, Robot, cold bending resistant, seawater resistant 	DSL-1204-G05MRN	6058500
	<ul style="list-style-type: none"> • Description: Sensor/actuator cable, unshielded • Connection type head A: Female connector, M12, 4-pin, angled • Connection type head B: Male connector, M12, 4-pin, straight • Signal type: Sensor/actuator cable • Cable: 2 m, 4-wire, PP • Note: This product is generally resistant to chemical cleaning agents (see ECOLAB) and other chemical compounds such as H2O2 and CH2O2. Before permanent installation is carried out, the material's resistance to the cleaning agent being used must be checked., Resistant against lactic acid & hydrogen peroxide (H2O2) • Application: Hygienic and washdown zones, Drag chain operation, Robot, cold bending resistant, seawater resistant 	DSL-1204-B02MRN	6058502
	<ul style="list-style-type: none"> • Description: Sensor/actuator cable, unshielded • Connection type head A: Female connector, M12, 4-pin, angled • Connection type head B: Male connector, M12, 4-pin, straight • Signal type: Sensor/actuator cable • Cable: 5 m, 4-wire, PP • Note: This product is generally resistant to chemical cleaning agents (see ECOLAB) and other chemical compounds such as H2O2 and CH2O2. Before permanent installation is carried out, the material's resistance to the cleaning agent being used must be checked., Resistant against lactic acid & hydrogen peroxide (H2O2) 	DSL-1204-B05MRN	6058503

	Brief description	Type	part no.
	<ul style="list-style-type: none"> Application: Hygienic and washdown zones, Drag chain operation, Robot, cold bending resistant, seawater resistant 		
	<ul style="list-style-type: none"> Description: Sensor/actuator cable, unshielded Connection type head A: Female connector, M12, 4-pin, straight Connection type head B: Male connector, M12, 4-pin, straight Signal type: Sensor/actuator cable Cable: 20 m, 4-wire, PP Note: This product is generally resistant to chemical cleaning agents (see ECOLAB) and other chemical compounds such as H2O2 and CH2O2. Before permanent installation is carried out, the material's resistance to the cleaning agent being used must be checked., Resistant against lactic acid & hydrogen peroxide (H2O2) Application: Hygienic and washdown zones, Drag chain operation, Robot, cold bending resistant, seawater resistant 	YF2AP4-020PA2M2AP4	2143765
	<ul style="list-style-type: none"> Description: Sensor/actuator cable, unshielded Connection type head A: Female connector, M12, 4-pin, straight Connection type head B: Flying leads Signal type: Sensor/actuator cable Cable: 30 m, 4-wire, PP Connection systems: Flying leads Note: This product is generally resistant to chemical cleaning agents (see ECOLAB) and other chemical compounds such as H2O2 and CH2O2. Before permanent installation is carried out, the material's resistance to the cleaning agent being used must be checked., Resistant against lactic acid & hydrogen peroxide (H2O2) Application: Hygienic and washdown zones, Drag chain operation, Robot, cold bending resistant, seawater resistant 	YF2AP4-300PA2XLEAX	2146867
	<ul style="list-style-type: none"> Description: Sensor/actuator cable, unshielded Connection type head A: Female connector, M12, 4-pin, angled Connection type head B: Male connector, M12, 4-pin, straight Signal type: Sensor/actuator cable Cable: 3 m, 4-wire, PP Note: This product is generally resistant to chemical cleaning agents (see ECOLAB) and other chemical compounds such as H2O2 and CH2O2. Before permanent installation is carried out, the material's resistance to the cleaning agent being used must be checked., Resistant against lactic acid & hydrogen peroxide (H2O2) Application: Hygienic and washdown zones, Drag chain operation 	YG2AP4-030PA2M2AP4	2151191
	<ul style="list-style-type: none"> Description: Unshielded Connection type head A: Male connector, M12, 4-pin, A-coded Connection type head B: Female connector, M12, 4-pin, A-coded Connection type head C: Female connector, M12, 4-pin, A-coded Cable: 0.11 m, PVC 	SYL-1204-G0M11-X1	6055011
Mounting systems			
	<ul style="list-style-type: none"> Description: Servo clamps, small, for servo flange (clamps, eccentric fastener), 3 pcs, without mounting material Items supplied: Without mounting hardware 	BEF-WK-RESOL	2039082

	Brief description	Type	part no.
shaft adaptation			
	<ul style="list-style-type: none"> Product segment: Shaft adaptation Product: Shaft couplings Description: Bellows coupling, shaft diameter 6 mm / 6 mm, maximum shaft offset: radial ± 0.25 mm, axial ± 0.4 mm, angular $\pm 4^\circ$; max. speed 10,000 rpm, -30°C to $+120^\circ\text{C}$, max. torque 120 Ncm; material: stainless steel bellows, aluminum hub 	KUP-0606-B	5312981
	<ul style="list-style-type: none"> Product segment: Shaft adaptation Product: Shaft couplings Description: Bellows coupling, shaft diameter 6 mm / 10 mm, maximum shaft offset: radial ± 0.25 mm, axial ± 0.4 mm, angular $\pm 4^\circ$; max. speed 10,000 rpm, -30°C to $+120^\circ\text{C}$, max. torque 120 Ncm; material: stainless steel bellows, aluminum hub 	KUP-0610-B	5312982
	<ul style="list-style-type: none"> Product segment: Shaft adaptation Product: Shaft couplings Description: Spring washer coupling, shaft diameter 6 mm / 10 mm, Maximum shaft offset: radial ± 0.3 mm, axial ± 0.4 mm, angular $\pm 2.5^\circ$; max. speed 12,000 rpm, -10° to $+80^\circ\text{C}$, max. torque 60 Ncm; material: aluminum flange, glass fiber-reinforced polyamide membrane and hardened steel coupling pin 	KUP-0610-F	5312985
	<ul style="list-style-type: none"> Product segment: Shaft adaptation Product: Shaft couplings Description: Double loop coupling, shaft diameter 6 mm / 10 mm, max. shaft offset: radially ± 2.5 mm, axially ± 3 mm, angle ± 10 degrees; max. speed 3,000 rpm, -30 to $+80$ degrees Celsius, torsional spring stiffness of 25 Nm/rad 	KUP-0610-D	5326697
	<ul style="list-style-type: none"> Product segment: Shaft adaptation Product: Shaft couplings Description: Claw coupling, shaft diameter 6 mm / 10 mm, damping element 80 shore blue, maximum shaft offset: radial ± 0.22 mm, axial ± 1 mm angular $\pm 1.3^\circ$, max. speed 19,000 rpm, angle of twist max. 10°, -30°C to $+80^\circ\text{C}$, max. torque 800 Ncm, tightening torque of screws: ISO 4029 150 Ncm, material: aluminum flange, damping element: polyurethane 	KUP-0610-J	2127056

SICK AT A GLANCE

SICK is one of the leading manufacturers of intelligent sensors and sensor solutions for industrial applications. A unique range of products and services creates the perfect basis for controlling processes securely and efficiently, protecting individuals from accidents and preventing damage to the environment.

We have extensive experience in a wide range of industries and understand their processes and requirements. With intelligent sensors, we can deliver exactly what our customers need. In application centers in Europe, Asia and North America, system solutions are tested and optimized in accordance with customer specifications. All this makes us a reliable supplier and development partner.

Comprehensive services complete our offering: SICK LifeTime Services provide support throughout the machine life cycle and ensure safety and productivity.

For us, that is “Sensor Intelligence.”

WORLDWIDE PRESENCE:

Contacts and other locations –www.sick.com