



WTB2S-2P3275S49

W2

PHOTOELECTRIC SENSORS

SICK
Sensor Intelligence.



Illustration may differ



Ordering information

Type	part no.
WTB2S-2P3275S49	1104637

Included in delivery: SCREW SET W2S/G2S (1)

Other models and accessories → www.sick.com/W2

Detailed technical data

Features

Functional principle	Photoelectric proximity sensor
Functional principle detail	Background suppression
Dimensions (W x H x D)	7.7 mm x 21.8 mm x 13.5 mm
Housing design (light emission)	Rectangular
Sensing range max.	4 mm ... 90 mm ¹⁾
Sensing range	10 mm ... 70 mm ¹⁾
Type of light	Visible red light
Light source	PinPoint LED ²⁾
Light spot size (distance)	2.2 mm x 9 mm (45 mm)
Wave length	640 nm
Adjustment	Cable
Special applications	Detecting small objects, Detecting perforated objects, Detecting uneven, shiny objects, Detecting objects wrapped in film, Detecting objects with position tolerances

¹⁾ Object with 90% remission (based on standard white, DIN 5033).

²⁾ Average service life: 100,000 h at T_J = +25 °C.

Mechanics/electronics

Supply voltage U_B	10 V DC ... 30 V DC ¹⁾
Ripple	< 5 V _{pp} ²⁾
Current consumption	20 mA ³⁾
Switching output	PNP
Switching mode	Light switching
Output current $I_{max.}$	≤ 50 mA
Response time	< 0.5 ms ⁴⁾
Switching frequency	1,000 Hz ⁵⁾
Connection type	Cable with M8 male connector, 4-pin, 200 mm ⁶⁾
Cable material	Plastic, PUR
Conductor cross section	0.09 mm ²
Cable diameter	Ø 3 mm
Circuit protection	A ⁷⁾ B ⁸⁾ D ⁹⁾
Housing material	Plastic, ABS/PC
Optics material	Plastic, PMMA
Enclosure rating	IP67
Ambient operating temperature	-25 °C ... +50 °C
Ambient temperature, storage	-40 °C ... +75 °C
UL File No.	NRKH.E181493

1) Limit values.

2) May not fall below or exceed U_y tolerances.

3) Without load.

4) Signal transit time with resistive load.

5) With light/dark ratio 1:1.

6) Do not bend below 0 °C.

7) A = V_S connections reverse-polarity protected.

8) B = output reverse-polarity protected.

9) D = outputs overcurrent and short-circuit protected.

Safety-related parameters

MTTF_D	1,547 years
DC_{avg}	0 %

Certificates

EU declaration of conformity	✓
UK declaration of conformity	✓
ACMA declaration of conformity	✓
Moroccan declaration of conformity	✓
China RoHS	✓
cULus certificate	✓
Photobiological safety (DIN EN 62471) certificate	✓

Classifications

ECLASS 5.0	27270904
ECLASS 5.1.4	27270904
ECLASS 6.0	27270904
ECLASS 6.2	27270904
ECLASS 7.0	27270904
ECLASS 8.0	27270904
ECLASS 8.1	27270904
ECLASS 9.0	27270904
ECLASS 10.0	27270904
ECLASS 11.0	27270904
ECLASS 12.0	27270903
ETIM 5.0	EC002719
ETIM 6.0	EC002719
ETIM 7.0	EC002719
ETIM 8.0	EC002719
UNSPSC 16.0901	39121528

Connection diagram Cd-092

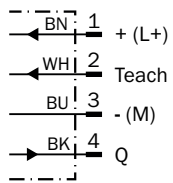

Characteristic curve WTB2S-2, 90 mm, line-shaped light spot

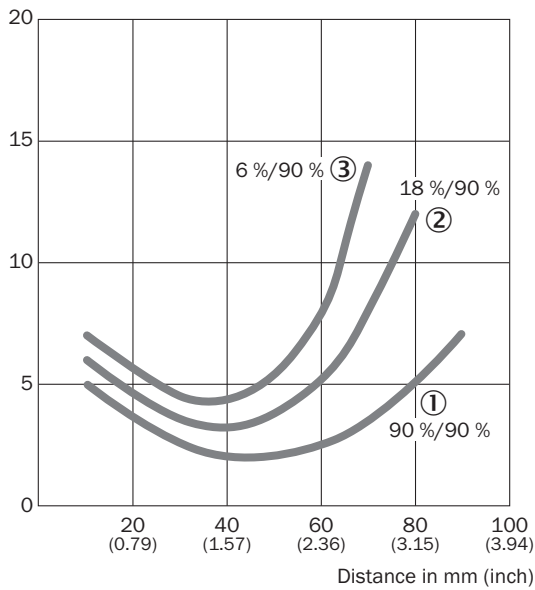

- ① Sensing range on white, 90% remission factor
- ② Sensing range on gray, 18% remission factor
- ③ Sensing range on black, 6% remission factor

Light spot size WTB2S-2, 90 mm, line-shaped light spot

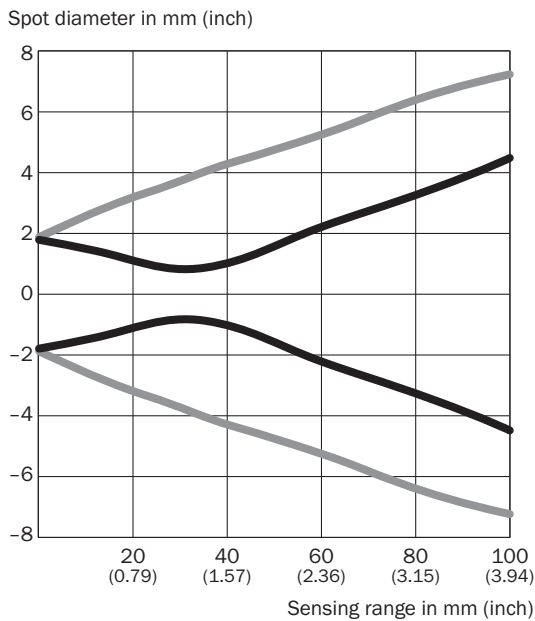

Dimensions in mm (inch)

Sensing range	Spot diameter	
	Vertical	Horizontal
0 (0.00)	3.5 (0.14)	3.8 (0.15)
10 (0.39)	3.0 (0.12)	5.2 (0.20)
20 (0.79)	3.3 (0.13)	6.4 (0.25)
30 (1.18)	1.8 (0.07)	7.4 (0.29)
40 (1.57)	2.0 (0.08)	8.6 (0.34)
60 (2.36)	4.4 (0.17)	10.5 (0.41)
80 (3.15)	6.5 (0.26)	12.8 (0.50)
100 (3.94)	9.0 (0.35)	14.5 (0.57)

- Vertical
- Horizontal

Light spot size WTB2S-2, 90 mm, line-shaped light spot

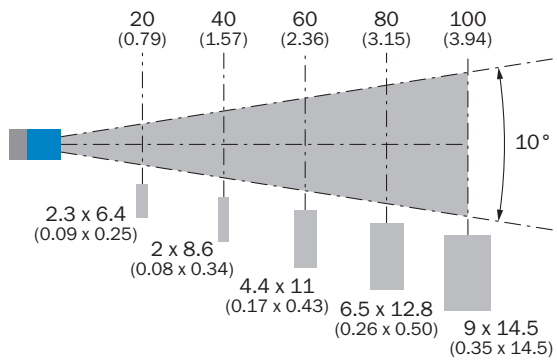

Sensing range diagram WTB2S-2, 90 mm, line-shaped light spot

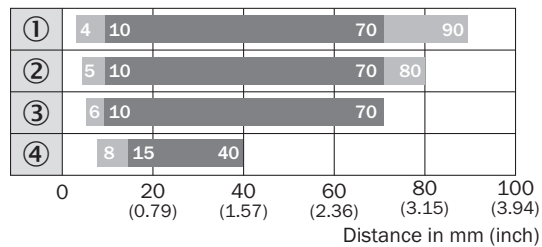

- Sensing range
- Sensing range max.
- ① Sensing range on white, 90% remission factor
- ② Sensing range on gray, 18% remission factor
- ③ Sensing range on black, 6% remission factor
- ④ Sensing range to ultra-black, 1% remission factor

Dimensional drawing WTB2S-2, 66 mm, 90 mm, 110 mm

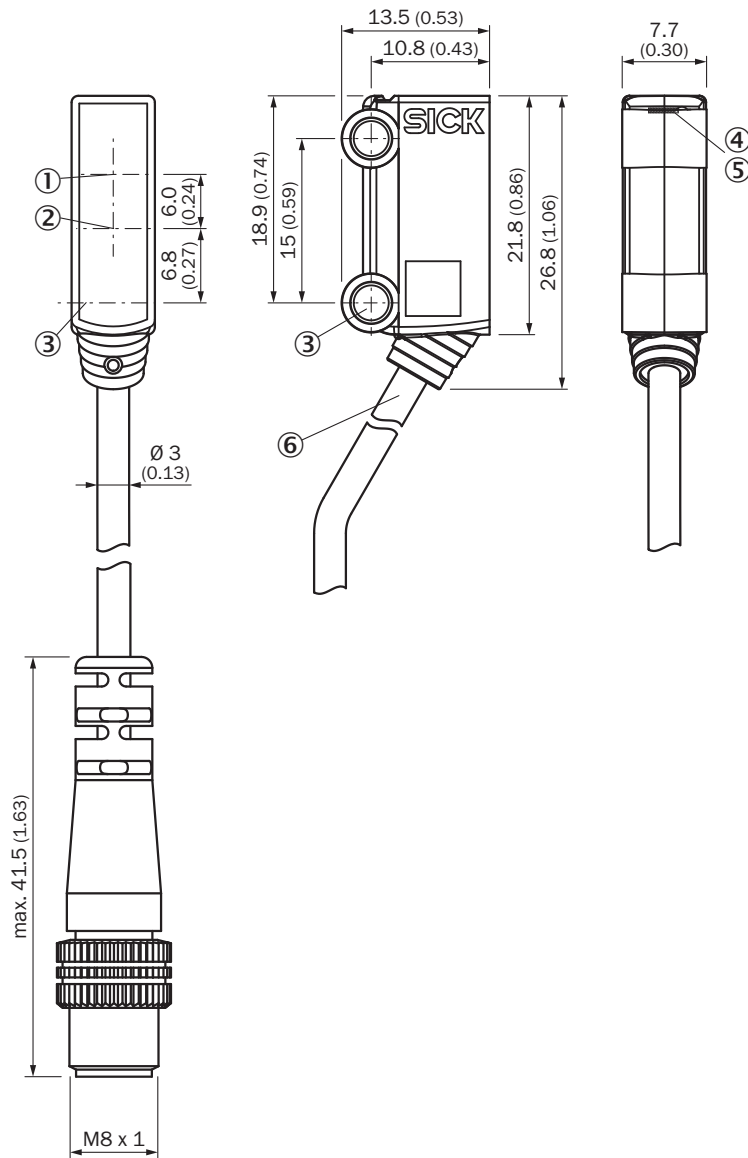





Dimensions in mm (inch)

- ① Optical axis, receiver
- ② Optical axis, sender
- ③ Middle axis fixing hole $\varnothing 3.2$ mm
- ④ LED indicator green: Supply voltage active
- ⑤ LED indicator yellow: Status of received light beam
- ⑥ Connection

Recommended accessories

Other models and accessories → www.sick.com/W2

	Brief description	Type	part no.
Mounting systems			
	<ul style="list-style-type: none"> Description: Mounting bracket for floor mounting Material: Steel Details: Steel, zinc coated Items supplied: Without mounting hardware Suitable for: W2S-2 	BEF-W2S-A	4034748
connectors and cables			
	<ul style="list-style-type: none"> Description: Sensor/actuator cable, unshielded Connection type head A: Female connector, M8, 4-pin, straight, A-coded Connection type head B: Flying leads Signal type: Sensor/actuator cable Cable: 5 m, 4-wire, PVC Application: Uncontaminated zones, Zones with chemicals 	YF8U14-050VA3XLEAX	2095889
	<ul style="list-style-type: none"> Description: Sensor/actuator cable, unshielded Connection type head A: Female connector, M8, 4-pin, straight, A-coded Connection type head B: Flying leads Signal type: Sensor/actuator cable Cable: 5 m, 4-wire, PUR, halogen-free Application: Drag chain operation, Zones with oils and lubricants, Robot, Drag chain operation 	YF8U14-050UA3XLEAX	2094792
	<ul style="list-style-type: none"> Description: Unshielded Connection type head A: Male connector, M8, 4-pin, straight, A-coded Connection systems: Screw-type terminals Permitted cross-section: 0.14 mm² ... 0.5 mm² 	STE-0804-G	6037323

SICK AT A GLANCE

SICK is one of the leading manufacturers of intelligent sensors and sensor solutions for industrial applications. A unique range of products and services creates the perfect basis for controlling processes securely and efficiently, protecting individuals from accidents and preventing damage to the environment.

We have extensive experience in a wide range of industries and understand their processes and requirements. With intelligent sensors, we can deliver exactly what our customers need. In application centers in Europe, Asia and North America, system solutions are tested and optimized in accordance with customer specifications. All this makes us a reliable supplier and development partner.

Comprehensive services complete our offering: SICK LifeTime Services provide support throughout the machine life cycle and ensure safety and productivity.

For us, that is “Sensor Intelligence.”

WORLDWIDE PRESENCE:

Contacts and other locations –www.sick.com