



deTec4 Set 30/1950

deTec

SAFETY LIGHT CURTAINS

SICK
Sensor Intelligence.



Ordering information

| Type | part no. |
|--------------------|----------|
| deTec4 Set 30/1950 | 1103386 |

Included in delivery: C4P-SA19531A00 (1), C4P-EA19531C00 (1), BEF-1SHABPKU4 (1), Protective cap, M12 for female connector (2), SP1-1100 (1), SP2-2100 (1)

Other models and accessories → www.sick.com/deTec

Detailed technical data

Features

| | |
|---------------------------------------|--|
| Product version | deTec4 |
| Application | Normal industrial environment |
| System part | Set |
| Resolution | 30 mm |
| Scanning range | 30 m |
| Protective field height | 1,950 mm |
| Response time | 14 ms (Uncoded) 25 ms (code 1 or code 2) |
| No blind zones | Yes |
| Synchronization | Optical synchronization |
| Integrated laser alignment aid | ✓ |
| Items supplied | Sender System plug 1100 Receiver System plug 2100 4 FlexFix brackets 2 protective caps M12 for female connector Test rod with diameter corresponding to the resolution of the safety light curtain Safety instruction Mounting instructions Operating instructions for download |

Safety-related parameters

| | |
|---|--------------------------|
| Type | Type 4 (IEC 61496-1) |
| Safety integrity level | SIL 3 (IEC 61508) |
| Category | Category 4 (ISO 13849-1) |
| Performance level | PL e (ISO 13849-1) |
| PFH_D (mean probability of a dangerous failure per hour) | |
| Single device | 15.3 x 10 ⁻⁹ |
| Cascade with one guest | 30.5 x 10 ⁻⁹ |
| Cascade with two guest devices | 45.6 x 10 ⁻⁹ |

| | |
|---|--|
| T_M (mission time) | 20 years (ISO 13849-1) |
| Safe state in the event of a fault | At least one OSSD is in the OFF state. |

Functions

| | |
|--|---|
| Protective operation | ✓ |
| Automatic calibration of the protective field width | ✓ |
| Beam coding | ✓ |
| Restart interlock | ✓ |
| External device monitoring (EDM) | ✓ |
| Cascading | ✓ |
| Smart presence detection | ✓ |
| Reduced resolution | ✓ |
| Dynamic protective field width during operation | ✓ |
| Differentiation between person and material | |
| 2-signal muting | ✓ |

Interfaces

| | |
|---|-----------------------------|
| System connection | Plug, M12, 5-pin |
| Length of cable | 200 mm |
| Cable diameter | 5 mm |
| Extension connection | Female connector M12, 5-pin |
| Length of cable | 150 mm |
| Cable diameter | 5 mm |
| Configuration method | DIP switch on system plug |
| Display elements | LEDs |
| Display of the synchronization status of the upper and lower beams | ✓ |
| Application diagnostic output (ADO) | ✓ |
| IO-Link | ✓ |
| Near Field Communication (NFC) | ✓ |

Electronics

| | |
|--|--|
| Protection class | III (IEC 61140) |
| Supply voltage V_S | 24 V DC (19.2 V ... 28.8 V) |
| Ripple | ≤ 10 % |
| Output signal switching devices (OSSDs) | |
| Type of output | 2 PNP semiconductors, short-circuit protected, cross-circuit monitored ¹⁾ |
| ON state, switching voltage HIGH | 24 V DC (V _S - 2.25 V DC ... V _S) |
| OFF state, switching voltage LOW | ≤ 2 V DC |
| Current-carrying capacity per OSSD | ≤ 500 mA |
| Application diagnostic output (ADO) | |

¹⁾ Applies to the voltage range between -30 V and +30 V.

| | |
|----------------------------------|--|
| Type of output | PNP semiconductor, short-circuit protected ¹⁾ |
| Output voltage HIGH (active) | $\geq V_s - 3 \text{ V}$ |
| Output voltage LOW (deactivated) | High resistance |
| Output current HIGH (active) | $\leq 100 \text{ mA}$ |

¹⁾ Applies to the voltage range between -30 V and +30 V.

Mechanics

| | |
|-------------------------|---------------------------|
| Dimensions | See dimensional drawing |
| Housing material | Aluminum extruded profile |

Ambient data

| | |
|--------------------------------------|---|
| Enclosure rating | IP65 (IEC 60529) IP67 (IEC 60529) |
| Ambient operating temperature | -30 °C ... +55 °C |
| Storage temperature | -30 °C ... +70 °C |
| Air humidity | 15 % ... 95 %, Non-condensing |
| Vibration resistance | 5 ... 150 Hz, 3,5 mm / 1 g (EN 60068-2-6) |
| Shock resistance | 15 g / 6 ms (EN 60068-2-27) |
| Class | 3M4 (IEC TR 60721-4-3) |

Other information

| | |
|---------------------------------------|--------------------------------|
| Wave length | 850 nm |
| Type of light | Near-infrared (NIR), invisible |
| Integrated laser alignment aid | ✓ |
| Laser class | 1 |
| Wave length | 650 nm |
| Type of light | Visible red light |

Classifications

| | |
|---------------------|----------|
| ECLASS 5.0 | 27272704 |
| ECLASS 5.1.4 | 27272704 |
| ECLASS 6.0 | 27272704 |
| ECLASS 6.2 | 27272704 |
| ECLASS 7.0 | 27272704 |
| ECLASS 8.0 | 27272704 |
| ECLASS 8.1 | 27272704 |
| ECLASS 9.0 | 27272704 |
| ECLASS 10.0 | 27272704 |
| ECLASS 11.0 | 27272704 |
| ECLASS 12.0 | 27272704 |
| ETIM 5.0 | EC002549 |
| ETIM 6.0 | EC002549 |
| ETIM 7.0 | EC002549 |
| ETIM 8.0 | EC002549 |

UNSPSC 16.0901

46171620

Dimensional drawing

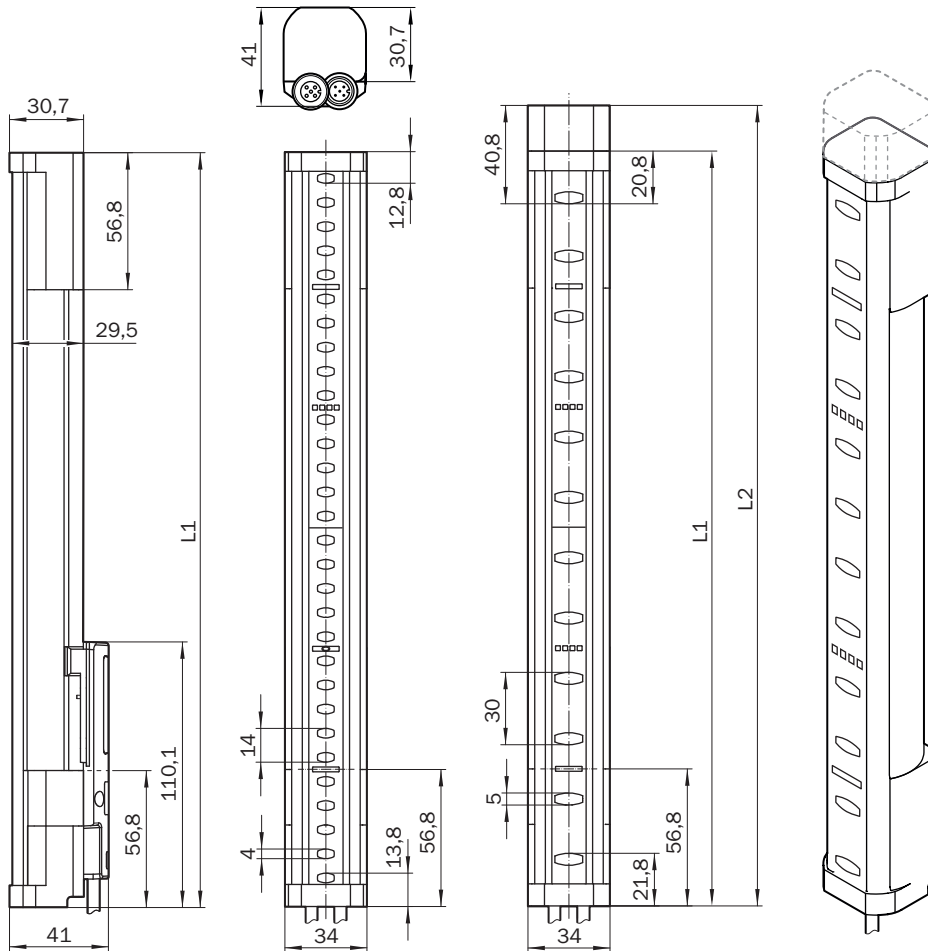

Dimensions in mm (inch)

| Protective field height | L1 | L2 |
|-------------------------|---------------|---------------|
| 300 (11.81) | 313 (12.32) | 332 (13.07) |
| 450 (17.72) | 463 (18.23) | 482 (18.98) |
| 600 (23.62) | 613 (24.13) | 632 (24.88) |
| 750 (29.53) | 763 (30.04) | 782 (30.79) |
| 900 (35.43) | 913 (35.94) | 932 (36.69) |
| 1,050 (41.34) | 1,063 (41.85) | 1,082 (42.6) |
| 1,200 (47.24) | 1,213 (47.75) | 1,232 (48.5) |
| 1,350 (53.15) | 1,362 (53.62) | 1,381 (54.37) |
| 1,500 (59.06) | 1,512 (59.53) | 1,531 (60.28) |
| 1,650 (64.96) | 1,662 (65.43) | 1,681 (66.18) |
| 1,800 (70.87) | 1,812 (71.34) | 1,831 (72.09) |
| 1,950 (76.77) | 1,962 (77.24) | 1,981 (77.99) |
| 2,100 (82.68) | 2,112 (83.15) | 2,131 (83.9) |

Dimensional drawing

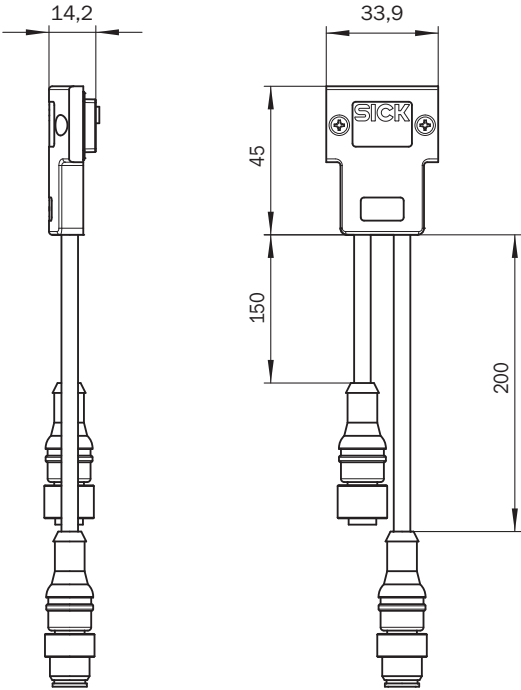

Dimensions in mm (inch)

Dimensional drawing



Dimensions in mm (inch)

Dimensional drawing

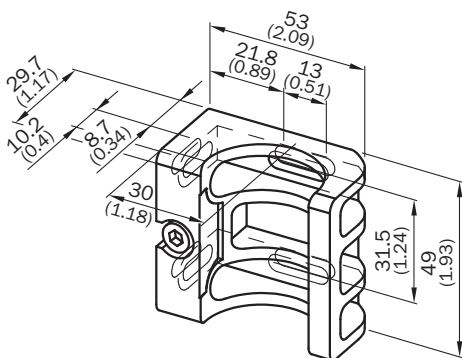

Dimensions in mm (inch)

Pinouts deTec4 extension connection



| Pin | Sender | Receiver |
|--|-----------|----------------|
| 1 | +24 V Out | +24 V Out |
| 2 | N. c. | In1EDMMuting |
| 3 | 0 V Out | 0 V Out |
| 4 | Sync-Out | In2RESMuting |
| 5 | MFP2 | MFP2ADOIO-Link |
| For details see operating instructions | | |

Pinouts deTec4 system connection







| Pin | Sender | Receiver |
|--|-------------------------------|----------|
| 1 | +24 V DC | +24 V DC |
| 2 | In2Laser alignment aid button | OSSD1 |
| 3 | 0 V DC | 0 V DC |
| 4 | In1Laser alignment aid switch | OSSD2 |
| 5 | MFP1 | MFP1 |
| For details see operating instructions | | |

Recommended accessories

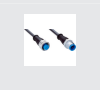
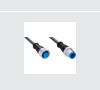
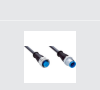
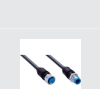
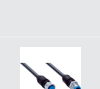

Other models and accessories → www.sick.com/deTec

| | Brief description | Type | part no. |
|---|---|--------------------|----------|
| Safety relays | | | |
|  | <ul style="list-style-type: none"> • Applications: Output expansion module for OSSDs • Compatible sensor types: Safety sensors with OSSDs • Connection type: Front connector with spring terminals • Restart interlock: no • External device monitoring (EDM): Via path • Outputs: 2 enabling current paths (safe), 1 feedback current path (for use as external device monitoring, not safe) • Housing width: 18 mm | RLY3-OSSD100 | 1085343 |
|  | <ul style="list-style-type: none"> • Applications: Output expansion module for OSSDs • Compatible sensor types: Safety sensors with OSSDs • Connection type: Front connector with spring terminals • Restart interlock: no • External device monitoring (EDM): Via path • Outputs: 4 enabling current paths (safe), 1 feedback current path (for use as external device monitoring, not safe), 1 signaling current path (not safe) • Housing width: 28 mm | RLY3-OSSD400 | 1099971 |
| Mounting systems | | | |
|  | <ul style="list-style-type: none"> • Description: FlexFix bracket for 2 devices (e.g. sender and receiver), can be aligned $\pm 15^\circ$, including M5 screw • Material: Plastic • Details: Plastic • Packing unit: 4 pieces | BEF-1SHABPKU4 | 2066614 |
|  | <ul style="list-style-type: none"> • Description: QuickFix bracket for 2 devices (e.g. sender and receiver) • Material: Plastic • Details: Plastic • Packing unit: 4 pieces | BEF-3SHABPKU4 | 2098710 |
|  | <ul style="list-style-type: none"> • Description: Muting arm bracket for deTec safety light curtain or deTem safety multibeam sensor • Packing unit: 1 piece • Suitable for: deTec, deTem | Muting arm bracket | 2106455 |
|  | <ul style="list-style-type: none"> • Description: Sensor bracket G6 and P250 | BEF-2KHAAKU1 | 2113145 |
|  | <ul style="list-style-type: none"> • Description: Muting arm, short • Suitable for: deTec, deTem | Muting arm, short | 2111924 |
|  | <ul style="list-style-type: none"> • Description: Muting arm, long • Suitable for: deTec, deTem | Muting arm, long | 2111923 |
|  | <ul style="list-style-type: none"> • Description: Universal holder for round steel arms and muting arms, for mounting sensors or reflectors | BEF-KHS-N01 | 2044953 |

| | Brief description | Type | part no. |
|---|--|--------------------|----------|
| connectors and cables | | | |
|  | <ul style="list-style-type: none"> Description: Unshielded Connection type head A: Female connector, M12, 5-pin, A-coded Connection type head B: Female connector, M12, 5-pin, A-coded Connection type head C: Male connector, M12, 5-pin, A-coded | DSC-1205T000025KMC | 6030664 |
|  | <ul style="list-style-type: none"> Description: Unshielded Connection type head A: Female connector, M12, 8-pin, A-coded Connection type head B: Female connector, M12, 8-pin, A-coded Connection type head C: Male connector, M12, 8-pin, A-coded | DSC-1208T000025KMC | 6058647 |
|  | <ul style="list-style-type: none"> Description: Sensor/actuator cable, unshielded Connection type head A: Female connector, M12, 5-pin, straight, A-coded Connection type head B: Flying leads Signal type: Sensor/actuator cable Cable: 2 m, 5-wire, PUR, halogen-free Application: Drag chain operation, Zones with oils and lubricants, Robot, Drag chain operation | YF2A15-020UB5XLEAX | 2095617 |
|  | <ul style="list-style-type: none"> Description: Sensor/actuator cable, unshielded Connection type head A: Female connector, M12, 5-pin, straight, A-coded Connection type head B: Flying leads Signal type: Sensor/actuator cable Cable: 5 m, 5-wire, PUR, halogen-free Application: Drag chain operation, Zones with oils and lubricants, Robot, Drag chain operation | YF2A15-050UB5XLEAX | 2095618 |
|  | <ul style="list-style-type: none"> Description: Sensor/actuator cable, unshielded Connection type head A: Female connector, M12, 5-pin, straight, A-coded Connection type head B: Flying leads Signal type: Sensor/actuator cable Cable: 10 m, 5-wire, PUR, halogen-free Application: Drag chain operation, Zones with oils and lubricants, Robot, Drag chain operation | YF2A15-100UB5XLEAX | 2095619 |
|  | <ul style="list-style-type: none"> Description: Sensor/actuator cable, unshielded Connection type head A: Female connector, M12, 8-pin, straight, A-coded Connection type head B: Flying leads Signal type: Sensor/actuator cable Cable: 5 m, 8-wire, PUR, halogen-free Application: Drag chain operation, Zones with oils and lubricants, Robot, Drag chain operation | YF2A18-050UA5XLEAX | 2095653 |
|  | <ul style="list-style-type: none"> Description: Sensor/actuator cable, unshielded Connection type head A: Female connector, M12, 8-pin, straight, A-coded Connection type head B: Flying leads Signal type: Sensor/actuator cable Cable: 10 m, 8-wire, PUR, halogen-free Application: Drag chain operation, Zones with oils and lubricants, Robot, Drag chain operation | YF2A18-100UA5XLEAX | 2095654 |
|  | <ul style="list-style-type: none"> Description: Sensor/actuator cable, unshielded Connection type head A: Female connector, M12, 5-pin, straight, A-coded Connection type head B: Male connector, M12, 5-pin, straight, A-coded Signal type: Sensor/actuator cable Cable: 2 m, 5-wire, PUR, halogen-free Application: Drag chain operation, Zones with oils and lubricants, Robot, Drag chain operation | YF2A15-020UB5M2A15 | 2096009 |
|  | <ul style="list-style-type: none"> Description: Sensor/actuator cable, unshielded Connection type head A: Female connector, M12, 5-pin, straight, A-coded Connection type head B: Male connector, M12, 5-pin, straight, A-coded Signal type: Sensor/actuator cable Cable: 5 m, 5-wire, PUR, halogen-free Application: Drag chain operation, Zones with oils and lubricants, Robot, Drag chain operation | YF2A15-050UB5M2A15 | 2096010 |
|  | <ul style="list-style-type: none"> Description: Sensor/actuator cable, unshielded Connection type head A: Female connector, M12, 5-pin, straight, A-coded Connection type head B: Male connector, M12, 5-pin, straight, A-coded Signal type: Sensor/actuator cable Cable: 10 m, 5-wire, PUR, halogen-free Application: Drag chain operation, Zones with oils and lubricants, Robot, Drag chain operation | YF2A15-100UB5M2A15 | 2096011 |
|  | <ul style="list-style-type: none"> Description: Sensor/actuator cable, unshielded Connection type head A: Female connector, M12, 8-pin, straight, A-coded Connection type head B: Male connector, M12, 8-pin, straight, A-coded Signal type: Sensor/actuator cable Cable: 2 m, 8-wire, PUR, halogen-free Application: Drag chain operation, Zones with oils and lubricants, Robot, Drag chain operation | YF2A18-020UA5M2A18 | 2096033 |
|  | <ul style="list-style-type: none"> Description: Sensor/actuator cable, unshielded Connection type head A: Female connector, M12, 8-pin, straight, A-coded Connection type head B: Male connector, M12, 8-pin, straight, A-coded Signal type: Sensor/actuator cable | YF2A18-050UA5M2A18 | 2096034 |

| | Brief description | Type | part no. |
|---|--|-----------------------------------|----------|
| | <ul style="list-style-type: none"> Cable: 5 m, 8-wire, PUR, halogen-free Application: Drag chain operation, Zones with oils and lubricants, Robot, Drag chain operation | | |
|  | <ul style="list-style-type: none"> Description: Sensor/actuator cable, unshielded Connection type head A: Female connector, M12, 8-pin, straight, A-coded Connection type head B: Male connector, M12, 8-pin, straight, A-coded Signal type: Sensor/actuator cable Cable: 10 m, 8-wire, PUR, halogen-free Application: Drag chain operation, Zones with oils and lubricants, Robot, Drag chain operation | YF2A18-100UA5M2A18 | 2096035 |
|  | | Muting connector | 2092758 |
|  | | IO-Link connector | 2092757 |
|  | <ul style="list-style-type: none"> Description: Sensor/actuator cable, unshielded Connection type head A: Female connector, M12, 8-pin, straight, A-coded Connection type head B: Flying leads Signal type: Sensor/actuator cable Cable: 2 m, 8-wire, PUR, halogen-free Application: Drag chain operation, Zones with oils and lubricants, Robot, Drag chain operation | YF2A18-020UA5XLEAX | 2095652 |
| system plugs and extension modules | | | |
|  | <ul style="list-style-type: none"> Function range: SP1 System connection: Plug, M12, 5-pin Extension connection: Without extension connection | SP1-1000 | 2076832 |
|  | <ul style="list-style-type: none"> Function range: SP1 System connection: Plug, M12, 5-pin Extension connection: Female connector M12, 5-pin | SP1-1100 | 2076833 |
|  | <ul style="list-style-type: none"> Function range: SP1 System connection: Male connector M12, 8-pin Extension connection: Without extension connection | SP1-1200 | 2076834 |
|  | <ul style="list-style-type: none"> Function range: SP1 System connection: Male connector M12, 8-pin Extension connection: Female connector M12, 5-pin | SP1-1300 | 2076835 |
|  | <ul style="list-style-type: none"> Function range: SP2 System connection: Plug, M12, 5-pin Extension connection: Without extension connection | SP2-2000 | 2093097 |
|  | <ul style="list-style-type: none"> Function range: SP2 System connection: Plug, M12, 5-pin Extension connection: Female connector M12, 5-pin | SP2-2100 | 2093098 |
|  | <ul style="list-style-type: none"> Function range: SP2 System connection: Male connector M12, 8-pin Extension connection: Without extension connection | SP2-2200 | 2093099 |
|  | <ul style="list-style-type: none"> Function range: SP2 System connection: Male connector M12, 8-pin Extension connection: Female connector M12, 5-pin | SP2-2300 | 2093100 |
| integration modules and adapters | | | |
|  | | IOLA2US-01101 (SiLink2 Master) | 1061790 |

| | Brief description | Type | part no. |
|---|--|----------------|----------|
| Photoelectric sensors | | | |
|  | <ul style="list-style-type: none"> • Sensing range max.: 5 mm ... 500 mm • Functional principle: Photoelectric proximity sensor • Connection type: Cable with M12 male connector, 4-pin, 300 mm • Type of light: Infrared light • Adjustment: Potentiometer • Housing: Rectangular | GTB6-P7441S56 | 1077541 |
|  | <ul style="list-style-type: none"> • Sensing range max.: 0.15 m ... 12 m, 0.15 m ... 10 m • Functional principle: Photoelectric retro-reflective sensor • Functional principle detail: With minimum distance to reflector (dual lens system) • Switching output: PNP • Switching mode: Light/dark switching • Connection type: Male connector M12, 4-pin • Light source: PinPoint LED • Adjustment: None | GL10-P4151 | 1069860 |
|  | <ul style="list-style-type: none"> • Sensing range max.: 0.03 m ... 6 m • Functional principle: Photoelectric retro-reflective sensor • Connection type: Cable with M12 male connector, 4-pin • Type of light: Visible red light • Adjustment: Potentiometer • Housing: Rectangular | GL6-P0211S49 | 1070568 |
|  | <ul style="list-style-type: none"> • Sensing range max.: 20 mm ... 950 mm • Functional principle: Photoelectric proximity sensor • Functional principle detail: Background suppression • Switching output: PNP • Switching mode: Light switching • Connection type: Male connector M12, 4-pin • Light source: PinPoint LED • Adjustment: Potentiometer | GTB10-P4411S01 | 1066852 |
| reflectors and optics | | | |
|  | <ul style="list-style-type: none"> • Description: Rectangular, screw connection • Dimensions: 51 mm 61 mm • Ambient operating temperature: -30 °C ... +65 °C | P250 | 5304812 |

| | Brief description | Type | part no. |
|---|-------------------|------------------|----------|
| network devices | | | |
|  | | SIG200-0A0G12200 | 1102605 |
|  | | SIG200-0A0412200 | 1089794 |
|  | | SIG200-0A0512200 | 1089796 |

SICK AT A GLANCE

SICK is one of the leading manufacturers of intelligent sensors and sensor solutions for industrial applications. A unique range of products and services creates the perfect basis for controlling processes securely and efficiently, protecting individuals from accidents and preventing damage to the environment.

We have extensive experience in a wide range of industries and understand their processes and requirements. With intelligent sensors, we can deliver exactly what our customers need. In application centers in Europe, Asia and North America, system solutions are tested and optimized in accordance with customer specifications. All this makes us a reliable supplier and development partner.

Comprehensive services complete our offering: SICK LifeTime Services provide support throughout the machine life cycle and ensure safety and productivity.

For us, that is “Sensor Intelligence.”

WORLDWIDE PRESENCE:

Contacts and other locations –www.sick.com