

AHS36I-BDQJ016384

AHS/AHM36

ABSOLUTE ENCODERS

SICK
Sensor Intelligence.



Illustration may differ



Ordering information

Type	part no.
AHS36I-BDQJ016384	1093786

Other models and accessories → www.sick.com/AHS_AHM36

Detailed technical data

Safety-related parameters

MTTF_D (mean time to dangerous failure)	240 years (EN ISO 13849-1)
--	----------------------------

Performance

Number of steps per revolution (max. resolution)	16,384 (14 bit)
Error limits G	0.35° (at 20 °C) ¹⁾
Repeatability standard deviation σ_r	0.2° (at 20 °C) ²⁾

¹⁾ In accordance with DIN ISO 1319-1, position of the upper and lower error limit depends on the installation situation, specified value refers to a symmetrical position, i.e. deviation in upper and lower direction is the same.

²⁾ In accordance with DIN ISO 55350-13; 68.3% of the measured values are inside the specified area.

Interfaces

Communication interface	IO-Link
Communication Interface detail	IO-Link V1.1
Initialization time	2 s ¹⁾
Cycle time	≤ 3.2 ms
Smart Sensor	Efficient communication, Enhanced Sensing, diagnosis
Process data	Position, speed, electronic cams, limit values, linear position, linear speed, errors and warnings, switching signals on pin 2
Parameterising data	Number of steps per revolution PRESET Counting direction Sampling rate for speed calculation Unit for output of the speed value Electronic cams(2 channels x 8 cams) Limit values Linear measuring length per 360° Pin 2 configuration

¹⁾ Valid positional data can be read once this time has elapsed.

Available diagnostics data	Minimum and maximum temperature Maximum speed Power-on counter Operating hours counter power-on/motion Counter of direction changes/number of movements cw/number of movements ccw Minimum and maximum operating voltage Distance covered
Status information	Via status LED
Switching input/Switching output	✓
Pin 2 input frequency	≤ 100 Hz
Output frequency pin 2	≤ 100 Hz

¹⁾ Valid positional data can be read once this time has elapsed.

Electronics

Connection type	Cable, 4-wire, universal, 0.5 m
Supply voltage	18 ... 30 V
Power consumption	≤ 1.5 W
Reverse polarity protection	✓

Mechanics

Mechanical design	Blind hollow shaft
Shaft diameter	10 mm
Characteristics of the shaft	Front clamp
Weight	0.2 kg, Based on devices with male connector
Shaft material	Stainless steel 1,4305
Flange material	Stainless steel 1,4305
Material, stator coupling	Stainless steel 1,4305
Housing material	Stainless steel 1,4305
Material, cable	PUR
Start up torque	≤ 1 Ncm ¹⁾
Operating torque	≤ 1 Ncm ¹⁾
Permissible movement static	± 0.3 mm, ± 0.3 mm (radial, axial)
Permissible movement dynamic	± 0.1 mm (radial) ± 0.1 mm (axial)
Operating speed	≤ 6,000 min ⁻¹
Moment of inertia of the rotor	23 gcm ²
Bearing lifetime	2.0 x 10 ⁹ revolutions
Angular acceleration	≤ 500,000 rad/s ²

¹⁾ At 20 °C.

Ambient data

EMC	According to EN 61000-6-2, EN 61000-6-3 and EN 61131-9
Enclosure rating	IP67 (IEC 60529)

¹⁾ With additional mechanical cable mounting.

²⁾ The cable must also be fastened with the shortest possible distance to the encoder.

³⁾ For side-mounted encoders (horizontal encoder shaft, vertical stator coupling), additional damping measures may be required in some cases as resonances can arise. Furthermore, the cable must be fastened with the shortest possible distance to the encoder.

	IP69K (IEC 60529)
Permissible relative humidity	90 % (Condensation not permitted)
Operating temperature range	-40 °C ... +85 °C
Storage temperature range	-40 °C ... +100 °C, Without packaging
Resistance to shocks	100 g, 6 ms (EN 60068-2-27) ¹⁾ 2)
Resistance to vibration	20 g, 10 Hz ... 2,000 Hz (EN 60068-2-6) ^{1) 3)}

¹⁾ With additional mechanical cable mounting.

²⁾ The cable must also be fastened with the shortest possible distance to the encoder.

³⁾ For side-mounted encoders (horizontal encoder shaft, vertical stator coupling), additional damping measures may be required in some cases as resonances can arise. Furthermore, the cable must be fastened with the shortest possible distance to the encoder.

Certificates

EU declaration of conformity	✓
UK declaration of conformity	✓
ACMA declaration of conformity	✓
Moroccan declaration of conformity	✓
China RoHS	✓
cTUVus certificate	✓
Information according to Art. 3 of Data Act (Regulation EU 2023/2854)	✓

Classifications

ECLASS 5.0	27270502
ECLASS 5.1.4	27270502
ECLASS 6.0	27270590
ECLASS 6.2	27270590
ECLASS 7.0	27270502
ECLASS 8.0	27270502
ECLASS 8.1	27270502
ECLASS 9.0	27270502
ECLASS 10.0	27270502
ECLASS 11.0	27270502
ECLASS 12.0	27270502
ETIM 5.0	EC001486
ETIM 6.0	EC001486
ETIM 7.0	EC001486
ETIM 8.0	EC001486
UNSPSC 16.0901	41112113

Dimensional drawing Blind hollow shaft, cable

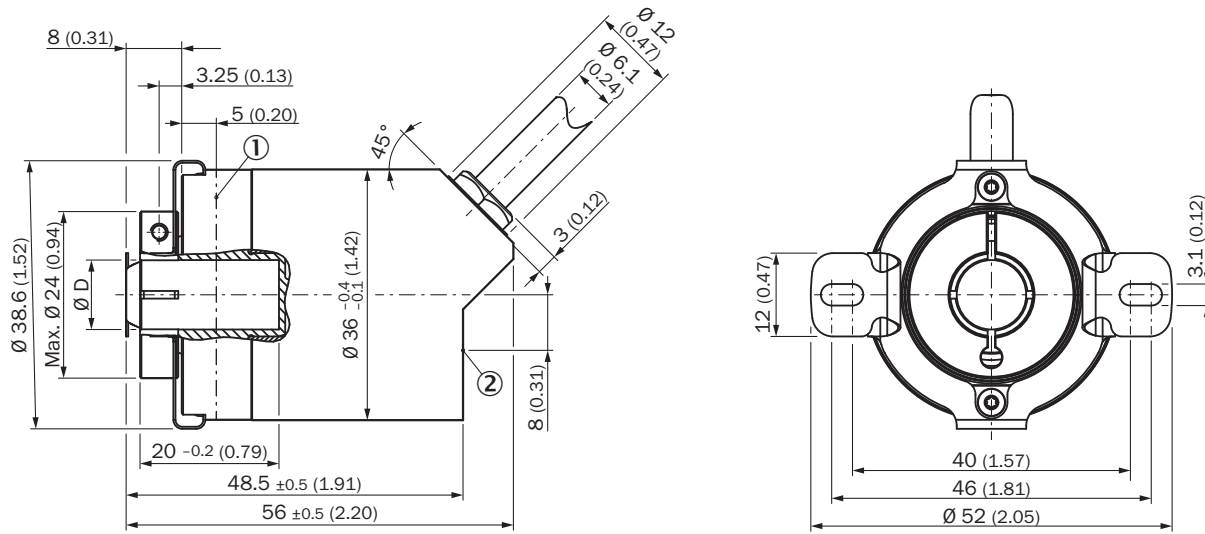

Dimensions in mm (inch)

Non-tolerated dimensions according to DIN-ISO 2768-mk

① Measuring point for operating temperature

② measuring point for vibrations

Type	Shaft diameter Ø D F7
AHx36x-BAxxxxxxx	6 mm
AHx36x-BBxxxxxxx	8 mm
AHx36x-BCxxxxxxx	1/4"
AHx36x-BDxxxxxxx	10 mm
AHx36x-BKxxxxxxx	3/8"

Attachment specifications

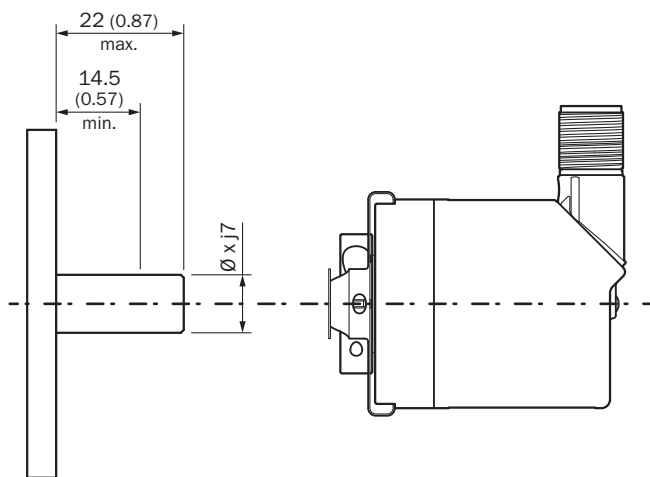

Anschlussbelegung

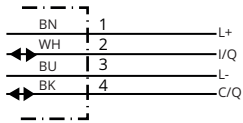









PIN	Wire color	Signal	Function		
			Basic	Advanced	Advanced Smart Task
-	-	-	Encoder supply voltage 18-30 V (+Us)		
1	Brown	L+	Encoder supply voltage 18-30 V (+Us)		
2	White	I/Q	Not connect- ed - no function	Multifunctional pin (configurable as switching input or switching output)	
3	Blue	L-	Encoder supply voltage 0 V (GND)		
4	Black	C/Q	IO-Link communication		
		-	-	Switching out- put (SIO mode)	





Recommended accessories

Other models and accessories → www.sick.com/AHS_AHM36

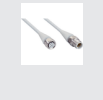
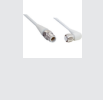
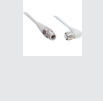
	Brief description	Type	part no.
connectors and cables			
	<ul style="list-style-type: none"> Description: Sensor/actuator cable, unshielded Connection type head A: Female connector, M12, 4-pin, straight Connection type head B: Flying leads Signal type: Sensor/actuator cable Cable: 2 m, 4-wire, PVC Connection systems: Flying leads Note: This product is generally resistant to chemical cleaning agents (see ECOLAB). Please do not use cleaning agents of any other Kind., Not resistant against lactic acid & hydrogen peroxide (H2O2) Application: Untaminated zones, Hygienic and washdown zones, Zones with chemicals 	YF2AP4-020VB3XLEAX	6052613
	<ul style="list-style-type: none"> Description: Sensor/actuator cable, unshielded Connection type head A: Female connector, M12, 4-pin, angled Connection type head B: Flying leads Signal type: Sensor/actuator cable Cable: 2 m, 4-wire, PVC Connection systems: Flying leads Note: This product is generally resistant to chemical cleaning agents (see ECOLAB). Please do not use cleaning agents of any other Kind., Not resistant against lactic acid & hydrogen peroxide (H2O2) Application: Untaminated zones, Hygienic and washdown zones, Zones with chemicals 	YG2AP4-020VB3XLEAX	6052614
	<ul style="list-style-type: none"> Description: Sensor/actuator cable, unshielded Connection type head A: Female connector, M12, 4-pin, straight Connection type head B: Flying leads Signal type: Sensor/actuator cable Cable: 5 m, 4-wire, PVC Connection systems: Flying leads Note: This product is generally resistant to chemical cleaning agents (see ECOLAB). Please do not use cleaning agents of any other Kind., Not resistant against lactic acid & hydrogen peroxide (H2O2) Application: Untaminated zones, Hygienic and washdown zones, Zones with chemicals 	YF2AP4-050VB3XLEAX	6052615
	<ul style="list-style-type: none"> Description: Sensor/actuator cable, unshielded Connection type head A: Female connector, M12, 4-pin, angled Connection type head B: Flying leads Signal type: Sensor/actuator cable Cable: 5 m, 4-wire, PVC Connection systems: Flying leads Note: This product is generally resistant to chemical cleaning agents (see ECOLAB). Please do not use cleaning agents of any other Kind., Not resistant against lactic acid & hydrogen peroxide (H2O2) Application: Untaminated zones, Hygienic and washdown zones, Zones with chemicals 	YG2AP4-050VB3XLEAX	6052616
	<ul style="list-style-type: none"> Description: Sensor/actuator cable, unshielded Connection type head A: Female connector, M12, 4-pin, straight Connection type head B: Flying leads Signal type: Sensor/actuator cable Cable: 10 m, 4-wire, PVC Connection systems: Flying leads Note: This product is generally resistant to chemical cleaning agents (see ECOLAB). Please do not use cleaning agents of any other Kind., Not resistant against lactic acid & hydrogen peroxide (H2O2) Application: Untaminated zones, Hygienic and washdown zones, Zones with chemicals 	YF2AP4-100VB3XLEAX	6052617
	<ul style="list-style-type: none"> Description: Sensor/actuator cable, unshielded Connection type head A: Female connector, M12, 4-pin, angled Connection type head B: Flying leads Signal type: Sensor/actuator cable Cable: 10 m, 4-wire, PVC Connection systems: Flying leads Note: This product is generally resistant to chemical cleaning agents (see ECOLAB). Please do not use cleaning agents of any other Kind., Not resistant against lactic acid & hydrogen peroxide (H2O2) Application: Untaminated zones, Hygienic and washdown zones, Zones with chemicals 	YG2AP4-100VB3XLEAX	6052618
	<ul style="list-style-type: none"> Description: Sensor/actuator cable, unshielded Connection type head A: Female connector, M12, 4-pin, straight Connection type head B: Male connector, M12, 4-pin, straight Signal type: Sensor/actuator cable Cable: 2 m, 4-wire, PVC 	YM2AP4-020VB3F2AP4	6052630

	Brief description	Type	part no.
	<ul style="list-style-type: none"> Note: This product is generally resistant to chemical cleaning agents (see ECOLAB). Please do not use cleaning agents of any other Kind., Not resistant against lactic acid & hydrogen peroxide (H2O2) Application: Uncontaminated zones, Hygienic and washdown zones, Zones with chemicals Description: Sensor/actuator cable, unshielded Connection type head A: Female connector, M12, 4-pin, straight Connection type head B: Male connector, M12, 4-pin, straight Signal type: Sensor/actuator cable Cable: 5 m, 4-wire, PVC Note: This product is generally resistant to chemical cleaning agents (see ECOLAB). Please do not use cleaning agents of any other Kind., Not resistant against lactic acid & hydrogen peroxide (H2O2) Application: Uncontaminated zones, Hygienic and washdown zones, Zones with chemicals 	YM2AP4-050VB3F2AP4	6052631
	<ul style="list-style-type: none"> Description: Sensor/actuator cable, unshielded Connection type head A: Female connector, M12, 4-pin, angled Connection type head B: Male connector, M12, 4-pin, straight Signal type: Sensor/actuator cable Cable: 2 m, 4-wire, PVC Note: This product is generally resistant to chemical cleaning agents (see ECOLAB). Please do not use cleaning agents of any other Kind., Not resistant against lactic acid & hydrogen peroxide (H2O2) Application: Uncontaminated zones, Hygienic and washdown zones, Zones with chemicals 	YM2AP4-020VB3G2AP4	6052633
	<ul style="list-style-type: none"> Description: Sensor/actuator cable, unshielded Connection type head A: Female connector, M12, 4-pin, angled Connection type head B: Male connector, M12, 4-pin, straight Signal type: Sensor/actuator cable Cable: 5 m, 4-wire, PVC Note: This product is generally resistant to chemical cleaning agents (see ECOLAB). Please do not use cleaning agents of any other Kind., Not resistant against lactic acid & hydrogen peroxide (H2O2) Application: Uncontaminated zones, Hygienic and washdown zones, Zones with chemicals 	YM2AP4-050VB3G2AP4	6052634
	<ul style="list-style-type: none"> Description: Sensor/actuator cable, unshielded Connection type head A: Female connector, M12, 4-pin, straight Connection type head B: Flying leads Signal type: Sensor/actuator cable Cable: 2 m, 4-wire, PP Connection systems: Flying leads Note: This product is generally resistant to chemical cleaning agents (see ECOLAB) and other chemical compounds such as H2O2 and CH2O2. Before permanent installation is carried out, the material's resistance to the cleaning agent being used must be checked., Resistant against lactic acid & hydrogen peroxide (H2O2) Application: Hygienic and washdown zones, Drag chain operation, Robot, cold bending resistant, seawater resistant 	DOL-1204-G02MRN	6058291
	<ul style="list-style-type: none"> Description: Sensor/actuator cable, unshielded Connection type head A: Female connector, M12, 4-pin, angled Connection type head B: Flying leads Signal type: Sensor/actuator cable Cable: 2 m, 4-wire, PP Connection systems: Flying leads Note: This product is generally resistant to chemical cleaning agents (see ECOLAB) and other chemical compounds such as H2O2 and CH2O2. Before permanent installation is carried out, the material's resistance to the cleaning agent being used must be checked., Resistant against lactic acid & hydrogen peroxide (H2O2) Application: Hygienic and washdown zones, Drag chain operation, Robot, cold bending resistant, seawater resistant 	DOL-1204-W02MRN	6058474
	<ul style="list-style-type: none"> Description: Sensor/actuator cable, unshielded Connection type head A: Female connector, M12, 4-pin, straight Connection type head B: Flying leads Signal type: Sensor/actuator cable Cable: 5 m, 4-wire, PP Connection systems: Flying leads Note: This product is generally resistant to chemical cleaning agents (see ECOLAB) and other chemical compounds such as H2O2 and CH2O2. Before permanent installation is carried out, the material's resistance to the cleaning agent being used must be checked., Resistant against lactic acid & hydrogen peroxide (H2O2) Application: Hygienic and washdown zones, Drag chain operation, Robot, cold bending resistant, seawater resistant 	DOL-1204-G05MRN	6058476
	<ul style="list-style-type: none"> Description: Sensor/actuator cable, unshielded Connection type head A: Female connector, M12, 4-pin, angled Connection type head B: Flying leads Signal type: Sensor/actuator cable Cable: 5 m, 4-wire, PP 	DOL-1204-W05MRN	6058477

	Brief description	Type	part no.
	<ul style="list-style-type: none"> • Connection systems: Flying leads • Note: This product is generally resistant to chemical cleaning agents (see ECOLAB) and other chemical compounds such as H2O2 and CH2O2. Before permanent installation is carried out, the material's resistance to the cleaning agent being used must be checked., Resistant against lactic acid & hydrogen peroxide (H2O2) • Application: Hygienic and washdown zones, Drag chain operation, Robot, cold bending resistant, seawater resistant 		
	<ul style="list-style-type: none"> • Description: Sensor/actuator cable, unshielded • Connection type head A: Female connector, M12, 4-pin, straight • Connection type head B: Flying leads • Signal type: Sensor/actuator cable • Cable: 10 m, 4-wire, PP • Connection systems: Flying leads • Note: This product is generally resistant to chemical cleaning agents (see ECOLAB) and other chemical compounds such as H2O2 and CH2O2. Before permanent installation is carried out, the material's resistance to the cleaning agent being used must be checked., Resistant against lactic acid & hydrogen peroxide (H2O2) • Application: Hygienic and washdown zones, Drag chain operation, Robot, cold bending resistant, seawater resistant 	DOL-1204-G10MRN	6058478
	<ul style="list-style-type: none"> • Description: Sensor/actuator cable, unshielded • Connection type head A: Female connector, M12, 4-pin, angled • Connection type head B: Flying leads • Signal type: Sensor/actuator cable • Cable: 10 m, 4-wire, PP • Connection systems: Flying leads • Note: This product is generally resistant to chemical cleaning agents (see ECOLAB) and other chemical compounds such as H2O2 and CH2O2. Before permanent installation is carried out, the material's resistance to the cleaning agent being used must be checked., Resistant against lactic acid & hydrogen peroxide (H2O2) • Application: Hygienic and washdown zones, Drag chain operation, Robot, cold bending resistant, seawater resistant 	DOL-1204-W10MRN	6058479
	<ul style="list-style-type: none"> • Description: Sensor/actuator cable, unshielded • Connection type head A: Female connector, M12, 4-pin, straight • Connection type head B: Male connector, M12, 4-pin, straight • Signal type: Sensor/actuator cable • Cable: 2 m, 4-wire, PP • Note: This product is generally resistant to chemical cleaning agents (see ECOLAB) and other chemical compounds such as H2O2 and CH2O2. Before permanent installation is carried out, the material's resistance to the cleaning agent being used must be checked., Resistant against lactic acid & hydrogen peroxide (H2O2) • Application: Hygienic and washdown zones, Drag chain operation, Robot, cold bending resistant, seawater resistant 	DSL-1204-G02MRN	6058499
	<ul style="list-style-type: none"> • Description: Sensor/actuator cable, unshielded • Connection type head A: Female connector, M12, 4-pin, straight • Connection type head B: Male connector, M12, 4-pin, straight • Signal type: Sensor/actuator cable • Cable: 5 m, 4-wire, PP • Note: This product is generally resistant to chemical cleaning agents (see ECOLAB) and other chemical compounds such as H2O2 and CH2O2. Before permanent installation is carried out, the material's resistance to the cleaning agent being used must be checked., Resistant against lactic acid & hydrogen peroxide (H2O2) • Application: Hygienic and washdown zones, Drag chain operation, Robot, cold bending resistant, seawater resistant 	DSL-1204-G05MRN	6058500
	<ul style="list-style-type: none"> • Description: Sensor/actuator cable, unshielded • Connection type head A: Female connector, M12, 4-pin, angled • Connection type head B: Male connector, M12, 4-pin, straight • Signal type: Sensor/actuator cable • Cable: 2 m, 4-wire, PP • Note: This product is generally resistant to chemical cleaning agents (see ECOLAB) and other chemical compounds such as H2O2 and CH2O2. Before permanent installation is carried out, the material's resistance to the cleaning agent being used must be checked., Resistant against lactic acid & hydrogen peroxide (H2O2) • Application: Hygienic and washdown zones, Drag chain operation, Robot, cold bending resistant, seawater resistant 	DSL-1204-B02MRN	6058502
	<ul style="list-style-type: none"> • Description: Sensor/actuator cable, unshielded • Connection type head A: Female connector, M12, 4-pin, angled • Connection type head B: Male connector, M12, 4-pin, straight • Signal type: Sensor/actuator cable • Cable: 5 m, 4-wire, PP • Note: This product is generally resistant to chemical cleaning agents (see ECOLAB) and other chemical compounds such as H2O2 and CH2O2. Before permanent installation is carried out, the material's resistance to the cleaning agent being used must be checked., Resistant against lactic acid & hydrogen peroxide (H2O2) 	DSL-1204-B05MRN	6058503

	Brief description	Type	part no.
	<ul style="list-style-type: none"> • Application: Hygienic and washdown zones, Drag chain operation, Robot, cold bending resistant, seawater resistant 		
	<ul style="list-style-type: none"> • Description: Sensor/actuator cable, unshielded • Connection type head A: Female connector, M12, 4-pin, straight • Connection type head B: Male connector, M12, 4-pin, straight • Signal type: Sensor/actuator cable • Cable: 20 m, 4-wire, PP • Note: This product is generally resistant to chemical cleaning agents (see ECOLAB) and other chemical compounds such as H2O2 and CH2O2. Before permanent installation is carried out, the material's resistance to the cleaning agent being used must be checked., Resistant against lactic acid & hydrogen peroxide (H2O2) • Application: Hygienic and washdown zones, Drag chain operation, Robot, cold bending resistant, seawater resistant 	YF2AP4-020PA2M2AP4	2143765
	<ul style="list-style-type: none"> • Description: Sensor/actuator cable, unshielded • Connection type head A: Female connector, M12, 4-pin, straight • Connection type head B: Flying leads • Signal type: Sensor/actuator cable • Cable: 30 m, 4-wire, PP • Connection systems: Flying leads • Note: This product is generally resistant to chemical cleaning agents (see ECOLAB) and other chemical compounds such as H2O2 and CH2O2. Before permanent installation is carried out, the material's resistance to the cleaning agent being used must be checked., Resistant against lactic acid & hydrogen peroxide (H2O2) • Application: Hygienic and washdown zones, Drag chain operation, Robot, cold bending resistant, seawater resistant 	YF2AP4-300PA2XLEAX	2146867
	<ul style="list-style-type: none"> • Description: Sensor/actuator cable, unshielded • Connection type head A: Female connector, M12, 4-pin, angled • Connection type head B: Male connector, M12, 4-pin, straight • Signal type: Sensor/actuator cable • Cable: 3 m, 4-wire, PP • Note: This product is generally resistant to chemical cleaning agents (see ECOLAB) and other chemical compounds such as H2O2 and CH2O2. Before permanent installation is carried out, the material's resistance to the cleaning agent being used must be checked., Resistant against lactic acid & hydrogen peroxide (H2O2) • Application: Hygienic and washdown zones, Drag chain operation 	YG2AP4-030PA2M2AP4	2151191
Mounting systems			
	<ul style="list-style-type: none"> • Product family: Stator couplings • Description: Standard stator coupling, AHS/AHM36 	BEF-DS16-AHX	2108615

SICK AT A GLANCE

SICK is one of the leading manufacturers of intelligent sensors and sensor solutions for industrial applications. A unique range of products and services creates the perfect basis for controlling processes securely and efficiently, protecting individuals from accidents and preventing damage to the environment.

We have extensive experience in a wide range of industries and understand their processes and requirements. With intelligent sensors, we can deliver exactly what our customers need. In application centers in Europe, Asia and North America, system solutions are tested and optimized in accordance with customer specifications. All this makes us a reliable supplier and development partner.

Comprehensive services complete our offering: SICK LifeTime Services provide support throughout the machine life cycle and ensure safety and productivity.

For us, that is “Sensor Intelligence.”

WORLDWIDE PRESENCE:

Contacts and other locations –www.sick.com