



TiM150-3010300

TiM

2D LIDAR SENSORS

**SICK**  
Sensor Intelligence.



### Ordering information

Type	part no.
TiM150-3010300	1093243

Other models and accessories → [www.sick.com/TiM](http://www.sick.com/TiM)



### Detailed technical data

#### Features

<b>Application</b>	Indoor
<b>Measurement principle</b>	HDDM <sup>+</sup>
<b>Light source</b>	Infrared (850 nm)
<b>Laser class</b>	1 (IEC 60825-1:2014, EN 60825-1:2014+A11:2021)
<b>Aperture angle</b>	Horizontal 200°
<b>Scanning frequency</b>	14.5 Hz
<b>Angular resolution</b>	Horizontal 1°
<b>Working range</b>	0.05 m ... 10 m
<b>Scanning range</b>	At 10% remission factor 2.8 m ... 3 m, depending on the angle

#### Mechanics/electronics

<b>Connection type</b>	1 x 5-pin M12 male device connector (rotatable)
<b>Supply voltage</b>	10 V DC ... 28 V DC <sup>1)</sup>
<b>Power consumption</b>	Typ. 2.7 W
<b>Output current</b>	≤ 100 mA
<b>Housing color</b>	Light blue (RAL 5012)
<b>Enclosure rating</b>	IP65 (IEC 60529:1989+AMD1:1999+AMD2:2013)
<b>Protection class</b>	III (IEC 61140:2016-1)
<b>Weight</b>	122 g, without connecting cables
<b>Dimensions (L x W x H)</b>	60 mm x 60 mm x 75.8 mm
<b>MTBF</b>	82 years
<b>MTTFd</b>	> 100 years

<sup>1)</sup> When using IO-Link output  $V_s > 18$  V.

## Safety-related parameters

<b>MTTF<sub>D</sub></b>	> 100 years
-------------------------	-------------

## Performance

<b>Response time</b>	Typ. 70 ms
<b>Detectable object shape</b>	Almost any
<b>Systematic error</b>	± 40 mm <sup>1)</sup>
<b>Statistical error</b>	30 mm <sup>1)</sup>
<b>Integrated application</b>	Field evaluation
<b>Number of field sets</b>	1 field set
<b>Simultaneous evaluation cases</b>	1 (2 fields)

<sup>1)</sup> Typical value; actual value depends on environmental conditions.

## Interfaces

<b>IO-Link</b>	✓
Function	Service interface, parameterization
<b>Digital inputs/outputs</b>	
Inputs	1
Outputs	2 (Push-pull)
<b>Delay time</b>	69 ms ... 30,015 ms (configurable)
<b>Dwell time</b>	69 ms ... 30,015 ms (configurable)
<b>Optical indicators</b>	2 LEDs (ON, switching status)

## Ambient data

<b>Remission factor</b>	4 % ... 1,000 % (reflectors)
<b>Electromagnetic compatibility (EMC)</b>	IEC 61000-6-3:2006+AMD1:2010 / IEC 61000-6-2:2005
<b>Vibration resistance</b>	
Sine resonance scan	10 Hz ... 1,000 Hz <sup>1)</sup>
Sine test	10 Hz ... 150 Hz, 1 g, 1 frequency cycles <sup>1)</sup>
Noise test	10 Hz ... 200 Hz, 5 g RMS, 2 h <sup>2)</sup>
<b>Ambient operating temperature</b>	-10 °C ... +50 °C
<b>Storage temperature</b>	-30 °C ... +70 °C
<b>Permissible relative humidity</b>	≤ 95 %, Non-condensing <sup>3)</sup>
<b>Ambient light immunity</b>	30,000 lx

<sup>1)</sup> IEC 60068-2-6:2007.

<sup>2)</sup> IEC 60068-2-64:2008.

<sup>3)</sup> EN 60068-2-30:2005.

## General notes

<b>Note on use</b>	The sensor does not constitute a safety component as defined by relevant legislation on machine safety.
--------------------	---

## Certificates

<b>EU declaration of conformity</b>	✓
<b>UK declaration of conformity</b>	✓

<b>ACMA declaration of conformity</b>	✓
<b>China RoHS</b>	✓
<b>cTUVus certificate</b>	✓
<b>Information according to Art. 3 of Data Act (Regulation EU 2023/2854)</b>	✓

Classifications

<b>ECLASS 5.0</b>	27270990
<b>ECLASS 5.1.4</b>	27270990
<b>ECLASS 6.0</b>	27270913
<b>ECLASS 6.2</b>	27270913
<b>ECLASS 7.0</b>	27270913
<b>ECLASS 8.0</b>	27270913
<b>ECLASS 8.1</b>	27270913
<b>ECLASS 9.0</b>	27270913
<b>ECLASS 10.0</b>	27270913
<b>ECLASS 11.0</b>	27270913
<b>ECLASS 12.0</b>	27270913
<b>ETIM 5.0</b>	EC002550
<b>ETIM 6.0</b>	EC002550
<b>ETIM 7.0</b>	EC002550
<b>ETIM 8.0</b>	EC002550
<b>UNSPSC 16.0901</b>	41111615

Dimensional drawing

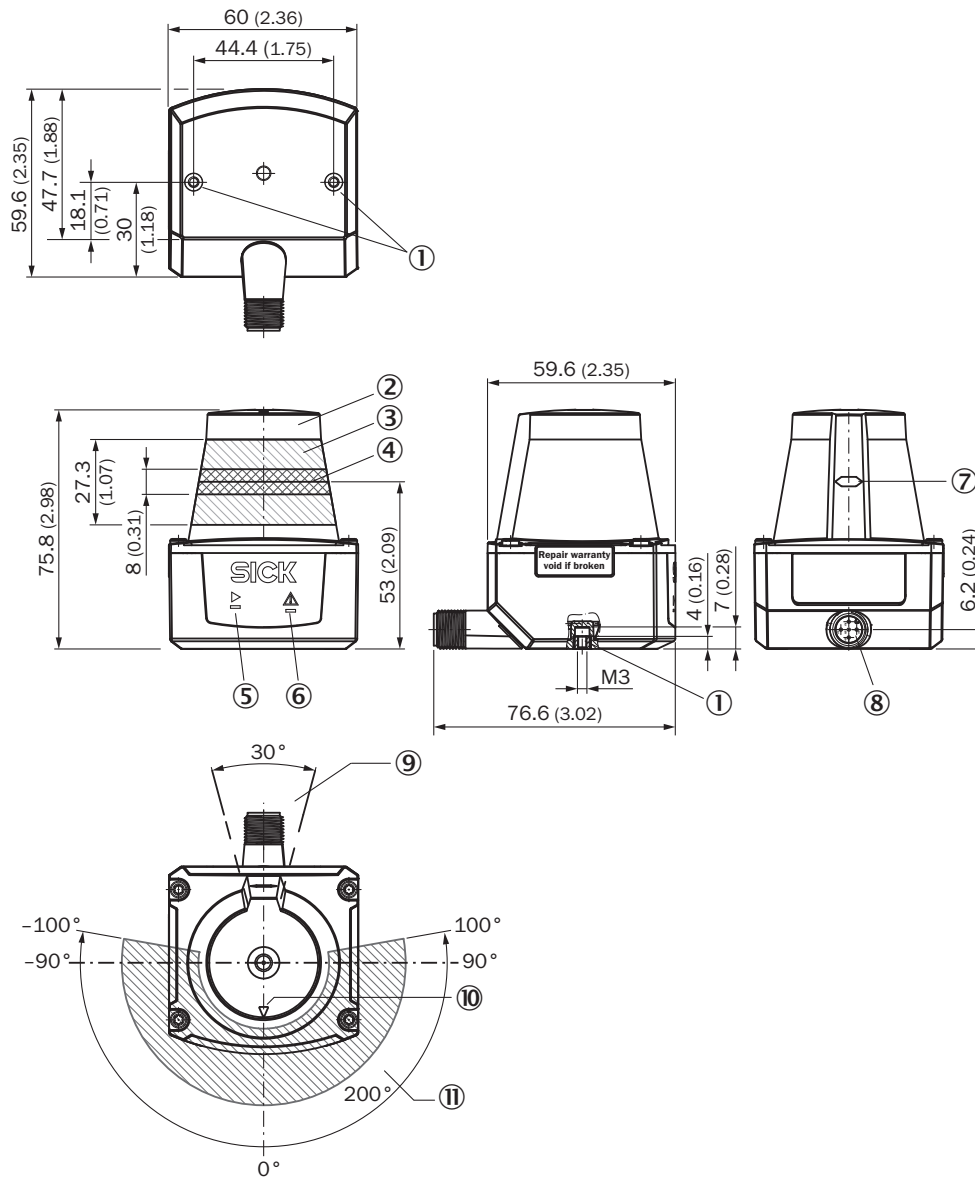

Dimensions in mm (inch)

- ① M3 threaded mounting hole, 2.8 mm deep (blind hole thread), max. tightening torque 0.7 Nm
- ② Optical hood
- ③ Receiving range (light inlet)
- ④ Transmission range (light emission)
- ⑤ green LED
- ⑥ red LED
- ⑦ Marking for the position of the light emission level
- ⑧ 5-pin M12 male connector (rotatable)
- ⑨ Area in which no reflective surfaces are allowed for mounted devices
- ⑩ bearing marking to support alignment (0° axis)
- ⑪ Aperture angle 200° (scanning angle)

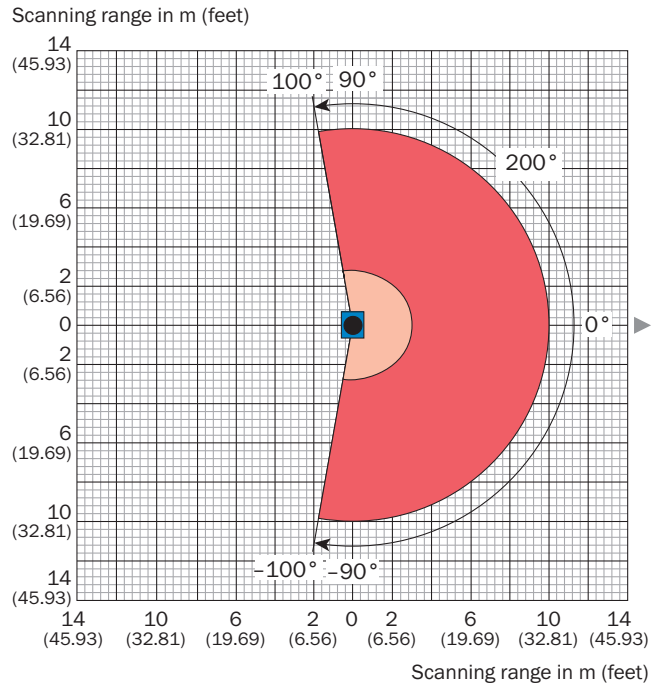

### Working range diagram





- Scanning range max. 10 m (32.81 ft)
- Scanning range 2.8 m to 3 m (9.19 ft to 9.84 ft) for objects with 10 % remission, dependent on the angle

### Recommended accessories

Other models and accessories → [www.sick.com/TiM](http://www.sick.com/TiM)

	Brief description	Type	part no.
network devices			
		IOLA2US-01101 (SiLink2 Master)	1061790
Mounting systems			
	<ul style="list-style-type: none"> <li><b>Description:</b> Mounting kit</li> <li><b>Dimensions (W x H x L):</b> 79 mm x 48 mm x 73 mm</li> <li><b>Items supplied:</b> Mounting bracket, 2 x cylinder head screws M3 x 8</li> <li><b>Suitable for:</b> TiM</li> </ul>	Mounting kit	2082188
	<ul style="list-style-type: none"> <li><b>Description:</b> Q-lock mounting system</li> </ul>	Q-Lock mounting kit	2083311

	Brief description	Type	part no.
connectors and cables			
	<ul style="list-style-type: none"> <li><b>Description:</b> Sensor/actuator cable, unshielded</li> <li><b>Connection type head A:</b> Female connector, M12, 5-pin, straight, A-coded</li> <li><b>Connection type head B:</b> Male connector, M12, 5-pin, straight, A-coded</li> <li><b>Signal type:</b> Sensor/actuator cable</li> <li><b>Cable:</b> 2 m, 5-wire, PUR, halogen-free</li> <li><b>Application:</b> Drag chain operation, Zones with oils and lubricants, Robot, Drag chain operation</li> </ul>	YF2A15-020UB5M2A15	2096009
	<ul style="list-style-type: none"> <li><b>Description:</b> Sensor/actuator cable, unshielded</li> <li><b>Connection type head A:</b> Female connector, M12, 5-pin, straight, A-coded</li> <li><b>Connection type head B:</b> Flying leads</li> <li><b>Signal type:</b> Sensor/actuator cable</li> <li><b>Cable:</b> 2 m, 5-wire, PUR, halogen-free</li> <li><b>Application:</b> Drag chain operation, Zones with oils and lubricants, Robot, Drag chain operation</li> </ul>	YF2A15-020UB5XLEAX	2095617

## SICK AT A GLANCE

SICK is one of the leading manufacturers of intelligent sensors and sensor solutions for industrial applications. A unique range of products and services creates the perfect basis for controlling processes securely and efficiently, protecting individuals from accidents and preventing damage to the environment.

We have extensive experience in a wide range of industries and understand their processes and requirements. With intelligent sensors, we can deliver exactly what our customers need. In application centers in Europe, Asia and North America, system solutions are tested and optimized in accordance with customer specifications. All this makes us a reliable supplier and development partner.

Comprehensive services complete our offering: SICK LifeTime Services provide support throughout the machine life cycle and ensure safety and productivity.

For us, that is “Sensor Intelligence.”

## WORLDWIDE PRESENCE:

Contacts and other locations –[www.sick.com](http://www.sick.com)