



IMC18-12NPPVC0SB00

IMC

INDUCTIVE PROXIMITY SENSORS

SICK
Sensor Intelligence.



Ordering information

Type	part no.
IMC18-12NPPVC0SB00	1093167

Included in delivery: BEF-MU-M18N (1)

Other models and accessories → www.sick.com/IMC

Illustration may differ



Detailed technical data

Features

Housing	Metric
Thread size	M18 x 1
Diameter	Ø 18 mm
Sensing range S_n	0 mm ... 12 mm ¹⁾
Safe sensing range S_a	9.72 mm
Number of switching points	Up to 4 adjustable switching points or windows
Switching modes	Single point, Window mode, Two point mode, Visual adjustment indicator
Switching frequency Qint.1 / Qint.2 on Pin2	250 Hz
Installation type	Non-flush
Connection type	Male connector M12, 4-pin ²⁾
Switching output	PNP
Switching output detail	PNP
Output Q/C	Switching output or IO-Link mode
Output MFC	Switching output or input
Output function	NC / NO
Output characteristic	Programmable
Electrical wiring	DC 4-wire
Enclosure rating	IP68 ³⁾ IP69K ⁴⁾
Special features	Smart Task, Resistant against coolant lubricants

¹⁾ Adjustable. Teaching outside of the value range is not permitted since hysteresis and temperature drift can no longer be kept.

²⁾ With gold plated contact pins.

³⁾ According to EN 60529.

⁴⁾ According to ISO 20653:2013-03.

Special applications	Zones with coolants and lubricants, Difficult application conditions
Special characteristic	Without Sn teach limit
Pin 2 configuration	External input, Teach-in, switching signal
Items supplied	Mounting nut, V2A stainless steel, with locking teeth (2x)

¹⁾ Adjustable. Teaching outside of the value range is not permitted since hysteresis and temperature drift can no longer be kept.

²⁾ With gold plated contact pins.

³⁾ According to EN 60529.

⁴⁾ According to ISO 20653:2013-03.

Mechanics/electronics

Supply voltage	10 V DC ... 30 V DC ¹⁾
Ripple	≤ 10 %
Voltage drop	≤ 2 V ²⁾
Hysteresis	Programmable ³⁾
Reproducibility	≤ 5 % ⁴⁾ ⁵⁾
Temperature drift (of S_r)	± 10 %
EMC	According to EN 60947-5-2
Continuous current I_a	≤ 200 mA ⁶⁾
Short-circuit protection	✓
Power-up pulse protection	✓
Shock and vibration resistance	100 g / 2 ms / 500 cycles; 150 g / 1 Mio cycles; 10 Hz ... 55 Hz / 1 mm; 55 Hz ... 500 Hz / 60 g
Ambient operating temperature	-40 °C ... +75 °C
Housing material	Stainless steel V2A, DIN 1.4305 / AISI 303
Sensing face material	Plastic, LCP
Housing length	65 mm
Thread length	39 mm
Tightening torque, max.	Typ. 90 Nm ⁷⁾
UL File No.	E181493
Teach-in accuracy	+/- 3% of S _r
Resolution, typical (range)	40 μm (0 mm ... 8 mm) 75 μm (8 mm ... 10 mm) 150 μm (10 mm ... 12 mm)
Resolution, maximum (area)	75 μm (8 mm ... 10 mm) 150 μm (10 mm ... 12 mm) 300 μm (10 mm ... 12 mm)

¹⁾ IO-Link mode: 18 VDC ... 30 VDC.

²⁾ At I_a max.

³⁾ To comply with EN 60947-5-2, a hysteresis of approx. 10% must be set.

⁴⁾ Supply voltage U_B and constant ambient temperature T_a.

⁵⁾ Of S_r.

⁶⁾ 200 mA total for both switching outputs.

⁷⁾ Valid if toothed side of nut is used.

Communication interface

Communication interface	IO-Link V1.1
--------------------------------	--------------

Communication Interface detail	COM2 (38,4 kBaud)
Cycle time	5 ms
Process data length	32 Bit
Process data structure	Bit 0 = switching signal Q _{L1} Bit 1 = switching signal Q _{L2} Bit 2 = switching signal Q _{Int3} Bit 3 = switching signal Q _{Int4} Bit 16 ... 31 = distance value
Factory setting	Switching Point 1: reference value 1 Output: normally open Pin 2 configuration: input

Reference values

Note	Reference value in Digits for switching point in mm stored in the sensor
Reference value 1	12 mm
Reference value 2	10 mm
Reference value 3	8 mm
Reference value 4	5 mm

Reduction factors

Stainless steel (V2A, 304)	Approx. 0.7
Aluminum (Al)	Approx. 0.4
Copper (Cu)	Approx. 0.4
Brass (Br)	Approx. 0.4

Installation note

Remark	Associated graphic see "Installation"
A	18 mm
B	45 mm
C	18 mm
D	36 mm
E	12 mm
F	96 mm

Smart Task

Smart Task name	Base logics
Logic function	AND OR XOR Hysteresis
Timer function	Switch-on delay Off delay ON and OFF delay Impulse (one shot)
Inverter	Adjustable
Switching frequency	SIO Direct: 250 Hz ¹⁾

¹⁾ SIO Direct: sensor operation in standard I/O mode without IO-Link communication and without using internal sensor logic or time parameters (set to "direct"/"deactivated").

²⁾ SIO Logic: Sensor operation in standard I/O mode without IO-Link communication. Sensor-internal logic or timing parameters plus Automation Functions used.

³⁾ IOL: Sensor operation with full IO-Link communication and usage of logic, timing and Automation Function parameters.

Switching signal		SIO Logic: 250 Hz ²⁾ IOL: 250 Hz ³⁾
	Switching signal Q _{L1}	Switching output
	Switching signal Q _{L2}	Switching output

¹⁾ SIO Direct: sensor operation in standard I/O mode without IO-Link communication and without using internal sensor logic or time parameters (set to "direct"/"deactivated").

²⁾ SIO Logic: Sensor operation in standard I/O mode without IO-Link communication. Sensor-internal logic or timing parameters plus Automation Functions used.

³⁾ IOL: Sensor operation with full IO-Link communication and usage of logic, timing and Automation Function parameters.

Certificates

EU declaration of conformity	✓
UK declaration of conformity	✓
ACMA declaration of conformity	✓
Moroccan declaration of conformity	✓
China RoHS	✓
IO-Link certificate	✓
Information according to Art. 3 of Data Act (Regulation EU 2023/2854)	✓

Classifications

ECLASS 5.0	27270101
ECLASS 5.1.4	27270101
ECLASS 6.0	27270101
ECLASS 6.2	27270101
ECLASS 7.0	27270101
ECLASS 8.0	27270101
ECLASS 8.1	27270101
ECLASS 9.0	27270101
ECLASS 10.0	27270101
ECLASS 11.0	27270101
ECLASS 12.0	27274001
ETIM 5.0	EC002714
ETIM 6.0	EC002714
ETIM 7.0	EC002714
ETIM 8.0	EC002714
UNSPSC 16.0901	39122230

Installation note Non-flush installation

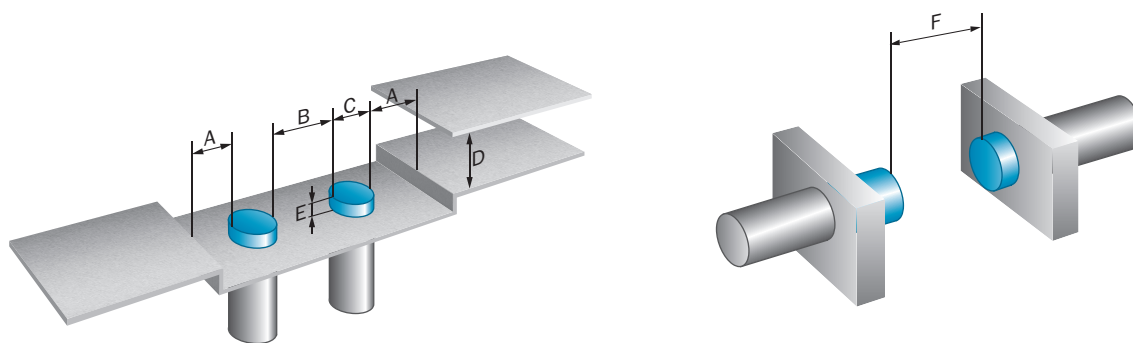

Connection diagram Cd-526

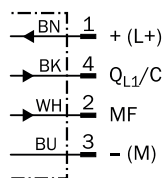

Q_{L1}/C = Switching output,
 IO-Link communication
 MF = Multifunction

Response diagram

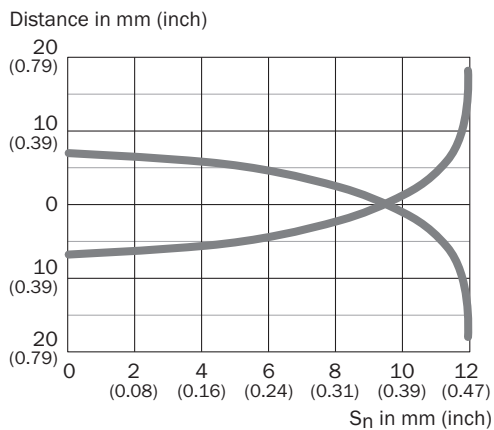



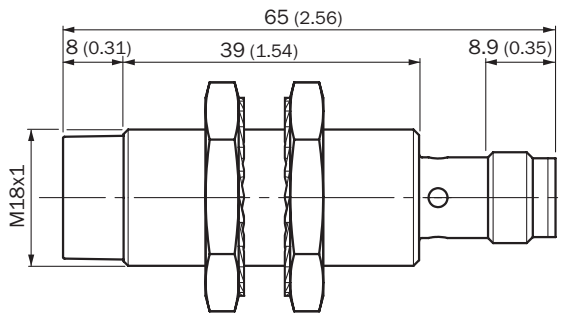

Dimensional drawing IMC18 Standard, connector M12, non-flush





Dimensions in mm (inch)

Recommended accessories

Other models and accessories → www.sick.com/IMC

	Brief description	Type	part no.
integration modules and adapters			
		IOLA2US-01101 (SiLink2 Master)	1061790
Mounting systems			
	<ul style="list-style-type: none"> Description: Mounting bracket for M18 sensors Material: Steel Details: Steel, zinc coated Items supplied: Without mounting hardware Suitable for: GR18, V180-2, V18, W15, Z1, Z2 	BEF-WN-M18	5308446
	<ul style="list-style-type: none"> Description: Mounting plate for M18 sensors Material: Stainless steel Details: Stainless steel Items supplied: Without mounting hardware 	BEF-WG-M18N	5320948
	<ul style="list-style-type: none"> Description: Mounting bracket for M18 sensors Material: Stainless steel Details: Stainless steel Items supplied: Without mounting hardware 	BEF-WN-M18N	5320947
	<ul style="list-style-type: none"> Description: Plate N06N for universal clamp bracket, M18 Material: Stainless steel, stainless steel Details: Stainless steel 1.4571 (sheet), Stainless steel 1.4408 (clamp) Items supplied: Universal clamp (5322627), mounting hardware Usable for: MH15, MH15V, V180-2, V18V, W15, GR18, V18, V18 Laser, V12-2, SimpleSense, SureSense, M18 round sensors 	BEF-KHS-N06N	2051622

	Brief description	Type	part no.
connectors and cables			
	<ul style="list-style-type: none"> Description: Sensor/actuator cable, unshielded Connection type head A: Female connector, M12, 4-pin, straight Connection type head B: Flying leads Signal type: Sensor/actuator cable Cable: 2 m, 4-wire, PP Connection systems: Flying leads Note: This product is generally resistant to chemical cleaning agents (see ECOLAB) and other chemical compounds such as H2O2 and CH2O2. Before permanent installation is carried out, the material's resistance to the cleaning agent being used must be checked., Resistant against lactic acid & hydrogen peroxide (H2O2) Application: Hygienic and washdown zones, Drag chain operation, Robot, cold bending resistant, seawater resistant 	DOL-1204-G02MRN	6058291
	<ul style="list-style-type: none"> Description: Sensor/actuator cable, unshielded Connection type head A: Female connector, M12, 4-pin, straight Connection type head B: Flying leads Signal type: Sensor/actuator cable Cable: 5 m, 4-wire, PP Connection systems: Flying leads Note: This product is generally resistant to chemical cleaning agents (see ECOLAB) and other chemical compounds such as H2O2 and CH2O2. Before permanent installation is carried out, the material's resistance to the cleaning agent being used must be checked., Resistant against lactic acid & hydrogen peroxide (H2O2) Application: Hygienic and washdown zones, Drag chain operation, Robot, cold bending resistant, seawater resistant 	DOL-1204-G05MRN	6058476
	<ul style="list-style-type: none"> Description: Sensor/actuator cable, unshielded Connection type head A: Female connector, M12, 4-pin, angled Connection type head B: Flying leads Signal type: Sensor/actuator cable Cable: 2 m, 4-wire, PP Connection systems: Flying leads Note: This product is generally resistant to chemical cleaning agents (see ECOLAB) and other chemical compounds such as H2O2 and CH2O2. Before permanent installation is carried out, the material's resistance to the cleaning agent being used must be checked., Resistant against lactic acid & hydrogen peroxide (H2O2) Application: Hygienic and washdown zones, Drag chain operation, Robot, cold bending resistant, seawater resistant 	DOL-1204-W02MRN	6058474
	<ul style="list-style-type: none"> Description: Sensor/actuator cable, unshielded Connection type head A: Female connector, M12, 4-pin, angled Connection type head B: Flying leads Signal type: Sensor/actuator cable Cable: 5 m, 4-wire, PP Connection systems: Flying leads Note: This product is generally resistant to chemical cleaning agents (see ECOLAB) and other chemical compounds such as H2O2 and CH2O2. Before permanent installation is carried out, the material's resistance to the cleaning agent being used must be checked., Resistant against lactic acid & hydrogen peroxide (H2O2) Application: Hygienic and washdown zones, Drag chain operation, Robot, cold bending resistant, seawater resistant 	DOL-1204-W05MRN	6058477
	<ul style="list-style-type: none"> Description: Sensor/actuator cable, unshielded Connection type head A: Female connector, M12, 4-pin, angled Connection type head B: Flying leads Signal type: Sensor/actuator cable Cable: 2 m, 4-wire, PP Connection systems: Flying leads Note: This product is generally resistant to chemical cleaning agents (see ECOLAB) and other chemical compounds such as H2O2 and CH2O2. Before permanent installation is carried out, the material's resistance to the cleaning agent being used must be checked., Resistant against lactic acid & hydrogen peroxide (H2O2), only suitable for PNP sensors Application: Hygienic and washdown zones, Drag chain operation, Robot, cold bending resistant, seawater resistant 	DOL-1204-L02MRN	6058482
	<ul style="list-style-type: none"> Description: Sensor/actuator cable, unshielded Connection type head A: Female connector, M12, 4-pin, angled Connection type head B: Flying leads Signal type: Sensor/actuator cable Cable: 5 m, 4-wire, PP Connection systems: Flying leads Note: This product is generally resistant to chemical cleaning agents (see ECOLAB) and other chemical compounds such as H2O2 and CH2O2. Before permanent installation is carried out, the material's resistance to the cleaning agent being used must be checked., Resistant against lactic acid & hydrogen peroxide (H2O2), only suitable for PNP sensors 	DOL-1204-L05MRN	6058483

	Brief description	Type	part no.
	<ul style="list-style-type: none"> Application: Hygienic and washdown zones, Drag chain operation, Robot, cold bending resistant, seawater resistant 		
	<ul style="list-style-type: none"> Description: Sensor/actuator cable, unshielded Connection type head A: Female connector, M12, 4-pin, straight Connection type head B: Male connector, M12, 4-pin, straight Signal type: Sensor/actuator cable Cable: 2 m, 4-wire, PP Note: This product is generally resistant to chemical cleaning agents (see ECOLAB) and other chemical compounds such as H2O2 and CH2O2. Before permanent installation is carried out, the material's resistance to the cleaning agent being used must be checked., Resistant against lactic acid & hydrogen peroxide (H2O2) Application: Hygienic and washdown zones, Drag chain operation, Robot, cold bending resistant, seawater resistant 	DSL-1204-G02MRN	6058499
	<ul style="list-style-type: none"> Description: Sensor/actuator cable, unshielded Connection type head A: Female connector, M12, 4-pin, straight Connection type head B: Male connector, M12, 4-pin, straight Signal type: Sensor/actuator cable Cable: 5 m, 4-wire, PP Note: This product is generally resistant to chemical cleaning agents (see ECOLAB) and other chemical compounds such as H2O2 and CH2O2. Before permanent installation is carried out, the material's resistance to the cleaning agent being used must be checked., Resistant against lactic acid & hydrogen peroxide (H2O2) Application: Hygienic and washdown zones, Drag chain operation, Robot, cold bending resistant, seawater resistant 	DSL-1204-G05MRN	6058500
	<ul style="list-style-type: none"> Description: Sensor/actuator cable, unshielded Connection type head A: Female connector, M12, 4-pin, angled Connection type head B: Male connector, M12, 4-pin, straight Signal type: Sensor/actuator cable Cable: 2 m, 4-wire, PP Note: This product is generally resistant to chemical cleaning agents (see ECOLAB) and other chemical compounds such as H2O2 and CH2O2. Before permanent installation is carried out, the material's resistance to the cleaning agent being used must be checked., Resistant against lactic acid & hydrogen peroxide (H2O2) Application: Hygienic and washdown zones, Drag chain operation, Robot, cold bending resistant, seawater resistant 	DSL-1204-B02MRN	6058502
	<ul style="list-style-type: none"> Description: Sensor/actuator cable, unshielded Connection type head A: Female connector, M12, 4-pin, angled Connection type head B: Male connector, M12, 4-pin, straight Signal type: Sensor/actuator cable Cable: 5 m, 4-wire, PP Note: This product is generally resistant to chemical cleaning agents (see ECOLAB) and other chemical compounds such as H2O2 and CH2O2. Before permanent installation is carried out, the material's resistance to the cleaning agent being used must be checked., Resistant against lactic acid & hydrogen peroxide (H2O2) Application: Hygienic and washdown zones, Drag chain operation, Robot, cold bending resistant, seawater resistant 	DSL-1204-B05MRN	6058503
	<ul style="list-style-type: none"> Description: Sensor/actuator cable, unshielded Connection type head A: Female connector, M12, 4-pin, straight, A-coded Connection type head B: Flying leads Signal type: Sensor/actuator cable Cable: 5 m, 4-wire, PUR, halogen-free Application: Drag chain operation, Zones with oils and lubricants, Robot, Drag chain operation 	YF2A14-050UB3XLEAX	2095608
	<ul style="list-style-type: none"> Description: Sensor/actuator cable, unshielded Connection type head A: Female connector, M12, 4-pin, straight Connection type head B: Male connector, M12, 4-pin, straight Signal type: Sensor/actuator cable Cable: 20 m, 4-wire, PP Note: This product is generally resistant to chemical cleaning agents (see ECOLAB) and other chemical compounds such as H2O2 and CH2O2. Before permanent installation is carried out, the material's resistance to the cleaning agent being used must be checked., Resistant against lactic acid & hydrogen peroxide (H2O2) Application: Hygienic and washdown zones, Drag chain operation, Robot, cold bending resistant, seawater resistant 	YF2AP4-020PA2M2AP4	2143765
	<ul style="list-style-type: none"> Description: Sensor/actuator cable, unshielded Connection type head A: Female connector, M12, 4-pin, straight, A-coded Connection type head B: Flying leads Signal type: Sensor/actuator cable Cable: 5 m, 4-wire, PVC Application: Uncontaminated zones, Zones with chemicals 	YF2A14-050VB3XLEAX	2096235
	<ul style="list-style-type: none"> Description: Sensor/actuator cable, unshielded Connection type head A: Female connector, M12, 4-pin, angled Connection type head B: Male connector, M12, 4-pin, straight 	YG2AP4-030PA2M2AP4	2151191

	Brief description	Type	part no.
	<ul style="list-style-type: none">• Signal type: Sensor/actuator cable• Cable: 3 m, 4-wire, PP• Note: This product is generally resistant to chemical cleaning agents (see ECOLAB) and other chemical compounds such as H2O2 and CH2O2. Before permanent installation is carried out, the material's resistance to the cleaning agent being used must be checked., Resistant against lactic acid & hydrogen peroxide (H2O2)• Application: Hygienic and washdown zones, Drag chain operation		

SICK AT A GLANCE

SICK is one of the leading manufacturers of intelligent sensors and sensor solutions for industrial applications. A unique range of products and services creates the perfect basis for controlling processes securely and efficiently, protecting individuals from accidents and preventing damage to the environment.

We have extensive experience in a wide range of industries and understand their processes and requirements. With intelligent sensors, we can deliver exactly what our customers need. In application centers in Europe, Asia and North America, system solutions are tested and optimized in accordance with customer specifications. All this makes us a reliable supplier and development partner.

Comprehensive services complete our offering: SICK LifeTime Services provide support throughout the machine life cycle and ensure safety and productivity.

For us, that is “Sensor Intelligence.”

WORLDWIDE PRESENCE:

Contacts and other locations –www.sick.com