



# MICS3-CBAZ40PZ1P01

microScan3

SAFETY LASER SCANNERS

**SICK**  
Sensor Intelligence.



Illustration may differ



### Ordering information

Type	part no.
MICS3-CBAZ40PZ1P01	1092720

Other models and accessories → [www.sick.com/microScan3](http://www.sick.com/microScan3)

### Detailed technical data

#### Features

<b>Product version</b>	microScan3 Pro - PROFINET
<b>Model</b>	Sensor including system plug (pre-mounted on the underside)
<b>Application</b>	Indoor
<b>Protective field range</b>	4 m
<b>Warning field range</b>	40 m
<b>Number of simultaneously monitored fields</b>	≤ 8 <sup>1)</sup>
<b>Number of fields</b>	128
<b>Number of monitoring cases</b>	128
<b>Scanning angle</b>	275°
<b>Resolution (can be configured)</b>	30 mm 40 mm 50 mm 70 mm 150 mm 200 mm
<b>Angular resolution</b>	0.39°
<b>Response time</b>	95 ms
<b>Protective field supplement</b>	65 mm

<sup>1)</sup> Protection, warning or contour detection fields.

#### Safety-related parameters

<b>Type</b>	Type 3 (IEC 61496)
<b>Safety integrity level</b>	SIL 2 (IEC 61508)
<b>Category</b>	Category 3 (EN ISO 13849)

<b>Performance level</b>	PL d (EN ISO 13849)
<b>PFH<sub>D</sub> (mean probability of a dangerous failure per hour)</b>	8.0 x 10 <sup>-8</sup>
<b>Conformities</b>	Conformance Class C
<b>T<sub>M</sub> (mission time)</b>	20 years (EN ISO 13849)
<b>Safe state in the event of a fault</b>	The safety outputs via the network are logic 0.

Functions

<b>Restart interlock</b>	✓
<b>Multiple sampling</b>	✓
<b>Monitoring case switching</b>	✓
<b>Simultaneous monitoring</b>	✓
<b>Static protective field switching</b>	✓
<b>Safe contour detection</b>	✓
<b>Contour as a reference</b>	✓
<b>Integrated configuration memory</b>	✓
<b>Measured data output</b>	Via Ethernet

Interfaces

<b>Connection type</b>		
	Voltage supply	1 x male connector, M12, 4-pin, A-coded
	Fieldbus, industrial network	2 x M12 female connectors, 4-pin, D-coded
<b>Outputs</b>		
	OSSD pairs	0
	Safety outputs via network	8
<b>Configuration method</b>		PC with Safety Designer (Configuration and Diagnostic Software)
<b>Configuration and diagnostics interface</b>		USB 2.0, Mini-USB, Ethernet
<b>Fieldbus, industrial network</b>		PROFINET
	Protocol	PROFIsafe
	Supported protocol versions	PROFINET specification V2.3 PROFIsafe profile in accordance with specification V2.6.1 PROFIsafe profile in accordance with specification V2.4
	GSDML	According to GSDML specification V2.33
	Cycle time	1 ms, 2 ms, 4 ms, 8 ms, 16 ms ...
	Conformance	Conformance Class C
	Network management	SNMP MIB-2 LLDP in accordance with IEEE 802.1AB MRP client support
	Net load	Net load class III in accordance with security level 1 test
	Switch properties	2 port real-time switch compliant with IEEE 802
	Port properties	100Base-TX Auto-negotiation Auto-crossover (MDIX)

Diagnostics	Auto-polarity
	I&M data sets 0 ... 5
Additional services	PROFINET alarms
	PROFenergy
	F_iPar_CRC
Additional interfaces	Acyclic read-/write services for communication via TCI
	SNTP (client and server)
	TCP/IP communication via port 9000
<b>Display elements</b>	Graphic color display, LEDs

### Electronics

<b>Protection class</b>	III (EN 61140)
<b>Supply voltage <math>V_s</math></b>	24 V DC (16.8 V DC ... 30 V DC)
<b>Power consumption typical</b>	7.2 W

### Mechanics

<b>Dimensions (W x H x D)</b>	112 mm x 150.7 mm x 111.1 mm (without system plug)
<b>Weight</b>	1.45 kg
<b>Housing material</b>	Aluminum
<b>Housing color</b>	RAL 1021 (yellow), RAL 9005 (black)
<b>Optics cover material</b>	Polycarbonate
<b>Optics cover surface finish</b>	Outside with scratch-resistant coating

### Ambient data

<b>Enclosure rating</b>	IP65 (IEC 60529)
<b>Ambient light immunity</b>	$\leq 40$ klx (IEC 61496-3) <sup>1)</sup>
<b>Ambient operating temperature</b>	-10 °C ... +50 °C
<b>Storage temperature</b>	-25 °C ... +70 °C
<b>Vibration resistance</b>	IEC 60068-2-6, IEC 60068-2-64, IEC 60721-3-5, IEC TR 60721-4-3, IEC 61496-1, IEC 61496-3
	Class 5M1 (IEC 60721-3-5)
	3M4 (IEC TR 60721-4-3)
<b>Shock resistance</b>	IEC 60068-2-27, IEC 60721-3-5, IEC TR 60721-4-3, IEC 61496-1, IEC 61496-3
	Class 5M1 (IEC 60721-3-5)
	3M4 (IEC TR 60721-4-3)
	Continuous shock 100 m/s <sup>2</sup> , 16 ms
	150 m/s <sup>2</sup> , 6 ms
<b>EMC</b>	IEC 61496-1, IEC 61000-6-2, IEC 61000-6-4

<sup>1)</sup> Typical ambient light immunity, for ambient light sources directly in the scan plane in accordance with IEC 61496-3:  $\leq 3$  klx.

### Other information

<b>Type of light</b>	Pulsed laser diode
<b>Wave length</b>	845 nm
<b>Detectable remission factor</b>	1.8% to several 1000%
<b>Laser class</b>	1 (21 CFR 1040.10 and 1040.11, IEC 60825-1)

## Classifications

<b>ECLASS 5.0</b>	27272705
<b>ECLASS 5.1.4</b>	27272705
<b>ECLASS 6.0</b>	27272705
<b>ECLASS 6.2</b>	27272705
<b>ECLASS 7.0</b>	27272705
<b>ECLASS 8.0</b>	27272705
<b>ECLASS 8.1</b>	27272705
<b>ECLASS 9.0</b>	27272705
<b>ECLASS 10.0</b>	27272705
<b>ECLASS 11.0</b>	27272705
<b>ECLASS 12.0</b>	27272705
<b>ETIM 5.0</b>	EC002550
<b>ETIM 6.0</b>	EC002550
<b>ETIM 7.0</b>	EC002550
<b>ETIM 8.0</b>	EC002550
<b>UNSPSC 16.0901</b>	39121528

## Certificates

<b>EU declaration of conformity</b>	✓
<b>UK declaration of conformity</b>	✓
<b>ACMA declaration of conformity</b>	✓
<b>China RoHS</b>	✓
<b>cULus certificate</b>	✓
<b>S Mark certificate</b>	✓
<b>Profinet certificate</b>	✓
<b>PROFIsafe certificate</b>	✓
<b>EC-Type-Examination approval</b>	✓
<b>China GB certificate</b>	✓
<b>PROFInergy certificate</b>	✓
<b>Information according to Art. 3 of Data Act (Regulation EU 2023/2854)</b>	✓

### Dimensional drawing

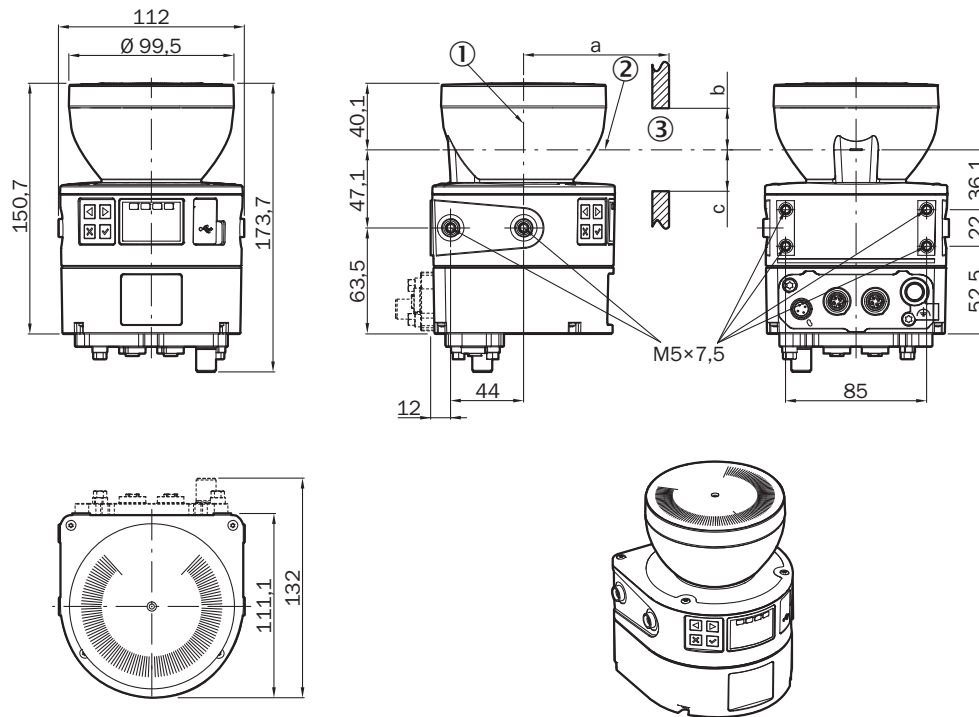

Dimensions in mm (inch)

① mirror axis of rotation

② scan plane

③ required viewing slit (a: length of the viewing slit, b: minimum height above the scan plane, c: minimum height below the scan plane. See the operating instructions for details.)

### Pinouts Voltage supply (XD1)

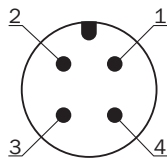

Pin	Designation	Description
1	+24 V DC	Supply voltage +24 V DC
2	n.c.	Not connected
3	0 V DC	Supply voltage 0 V DC
4	FE	Functional earth/shielding

For details see operating instructions

Pinouts Ethernet (XF1, XF2)









Pin	Designation	Description
1	TX+	Send data +
2	RX+	Receive data +
3	TX-	Send data -
4	RX-	Receive data -
Thread	SH	Shielding





For details see operating instructions

### Recommended accessories

Other models and accessories → [www.sick.com/microScan3](http://www.sick.com/microScan3)

	Brief description	Type	part no.
<b>Mounting systems</b>			
	<ul style="list-style-type: none"> <li><b>Description:</b> Mounting bracket, heavy-duty version, with protection cover, for floor mounting, height adjustment possible from 90 ... 310 mm, scanner tilt angle: ± 5°. Additional mounting brackets are not required.</li> <li><b>Dimensions (W x H x L):</b> 200 mm x 366 mm x 269 mm</li> <li><b>Material:</b> Steel</li> <li><b>Details:</b> Steel, painted (RAL 1021)</li> <li><b>Color:</b> RAL 1021 (yellow)</li> <li><b>Packing unit:</b> 1 piece</li> </ul>	Heavy-duty mounting kit for floor mounting	2102289
	<ul style="list-style-type: none"> <li><b>Description:</b> Mounting bracket with protection of optics hood</li> <li><b>Material:</b> Stainless steel</li> <li><b>Details:</b> Stainless steel V2A (1.4301), powder-coated IGP-DURA face 5803A</li> <li><b>Color:</b> RAL 9005 (black)</li> <li><b>Packing unit:</b> 1 piece</li> </ul>	1b mounting kit	2074242
	<ul style="list-style-type: none"> <li><b>Description:</b> Mounting bracket</li> <li><b>Material:</b> Stainless steel</li> <li><b>Details:</b> Stainless steel V2A (1.4301), powder-coated IGP-DURA face 5803A</li> <li><b>Color:</b> RAL 9005 (black)</li> <li><b>Packing unit:</b> 1 piece</li> </ul>	Mounting kit 1a	2073851
	<ul style="list-style-type: none"> <li><b>Description:</b> Alignment bracket, alignment with cross-wise axis and depth axis possible, distance between mounting surface and device: 22.3 mm, only in conjunction with mounting kit 1a (2073851) or 1b (2074242)</li> <li><b>Material:</b> Stainless steel</li> <li><b>Details:</b> Stainless steel V2A (1.4301), powder-coated IGP-DURA face 5803A</li> <li><b>Color:</b> RAL 9005 (black)</li> <li><b>Packing unit:</b> 1 piece</li> </ul>	Mounting kit 2a	2073852
	<ul style="list-style-type: none"> <li><b>Description:</b> Mounting bracket 150 mm for floor mounting of microScan3</li> <li><b>Material:</b> Stainless steel</li> <li><b>Details:</b> Stainless steel</li> <li><b>Color:</b> Uncoated</li> <li><b>Packing unit:</b> 1 piece</li> <li><b>Items supplied:</b> Bracket and 4 x M5 screws for attaching the microScan3</li> </ul>	Mounting bracket 150 mm for floor mounting of microScan3	2112950
	<ul style="list-style-type: none"> <li><b>Description:</b> Mounting bracket 300 mm for floor mounting of microScan3</li> <li><b>Material:</b> Stainless steel</li> <li><b>Details:</b> Stainless steel</li> <li><b>Color:</b> Uncoated</li> <li><b>Packing unit:</b> 1 piece</li> <li><b>Items supplied:</b> Bracket and 4 x M5 screws for attaching the microScan3</li> </ul>	Mounting bracket 300 mm for floor mounting of microScan3	2112951
	<ul style="list-style-type: none"> <li><b>Description:</b> Alignment bracket, alignment with cross-wise axis and depth axis possible, distance between mounting surface and device: 52.3 mm, only in conjunction with mounting kit 1a (2073851) or 1b (2074242)</li> <li><b>Material:</b> Stainless steel</li> <li><b>Details:</b> Stainless steel V2A (1.4301), powder-coated IGP-DURA face 5803A</li> <li><b>Color:</b> RAL 9005 (black)</li> <li><b>Packing unit:</b> 1 piece</li> </ul>	Mounting kit 2b	2074184

	Brief description	Type	part no.
connectors and cables			
	<ul style="list-style-type: none"> <li>• <b>Connection type head A:</b> Male connector, M12, 4-pin, straight, D-coded</li> <li>• <b>Connection type head B:</b> Male connector, RJ45, 8-pin, straight</li> <li>• <b>Signal type:</b> Ethernet</li> <li>• <b>Cable:</b> 20 m, 4-wire, CAT5, CAT5e, PUR, halogen-free</li> <li>• <b>Description:</b> Ethernet, shielded</li> </ul>	SSL-2J04-G20ME60	6063700
	<ul style="list-style-type: none"> <li>• <b>Connection type head A:</b> Male connector, M12, 4-pin, angled, D-coded</li> <li>• <b>Connection type head B:</b> Male connector, RJ45, 8-pin, straight</li> <li>• <b>Signal type:</b> Ethernet</li> <li>• <b>Cable:</b> 20 m, 4-wire, CAT5, CAT5e, PUR, halogen-free</li> <li>• <b>Description:</b> Ethernet, shielded</li> </ul>	SSL-2J04-H20ME	6063701
	<ul style="list-style-type: none"> <li>• <b>Description:</b> Sensor/actuator cable, unshielded</li> <li>• <b>Connection type head A:</b> Female connector, M12, 4-pin, angled, A-coded</li> <li>• <b>Connection type head B:</b> Flying leads</li> <li>• <b>Signal type:</b> Sensor/actuator cable</li> <li>• <b>Cable:</b> 20 m, 4-wire, PUR, halogen-free</li> <li>• <b>Application:</b> Drag chain operation, Zones with oils and lubricants, Robot, Drag chain operation</li> </ul>	YG2A14-200UB3XLEAX	2095770
	<ul style="list-style-type: none"> <li>• <b>Description:</b> Sensor/actuator cable, unshielded</li> <li>• <b>Connection type head A:</b> Female connector, M12, 4-pin, angled, A-coded</li> <li>• <b>Connection type head B:</b> Flying leads</li> <li>• <b>Signal type:</b> Sensor/actuator cable</li> <li>• <b>Cable:</b> 2 m, 4-wire, PUR, halogen-free</li> <li>• <b>Application:</b> Drag chain operation, Zones with oils and lubricants, Robot, Drag chain operation</li> </ul>	YG2A14-020UB3XLEAX	2095766
	<ul style="list-style-type: none"> <li>• <b>Description:</b> Sensor/actuator cable, unshielded</li> <li>• <b>Connection type head A:</b> Female connector, M12, 4-pin, angled, A-coded</li> <li>• <b>Connection type head B:</b> Flying leads</li> <li>• <b>Signal type:</b> Sensor/actuator cable</li> <li>• <b>Cable:</b> 5 m, 4-wire, PUR, halogen-free</li> <li>• <b>Application:</b> Drag chain operation, Zones with oils and lubricants, Robot, Drag chain operation</li> </ul>	YG2A14-050UB3XLEAX	2095767
	<ul style="list-style-type: none"> <li>• <b>Description:</b> Sensor/actuator cable, unshielded</li> <li>• <b>Connection type head A:</b> Female connector, M12, 4-pin, angled, A-coded</li> <li>• <b>Connection type head B:</b> Flying leads</li> <li>• <b>Signal type:</b> Sensor/actuator cable</li> <li>• <b>Cable:</b> 10 m, 4-wire, PUR, halogen-free</li> <li>• <b>Application:</b> Drag chain operation, Zones with oils and lubricants, Robot, Drag chain operation</li> </ul>	YG2A14-100UB3XLEAX	2095768
	<ul style="list-style-type: none"> <li>• <b>Description:</b> Sensor/actuator cable, unshielded</li> <li>• <b>Connection type head A:</b> Female connector, M12, 4-pin, straight, A-coded</li> <li>• <b>Connection type head B:</b> Flying leads</li> <li>• <b>Signal type:</b> Sensor/actuator cable</li> <li>• <b>Cable:</b> 2 m, 4-wire, PUR, halogen-free</li> <li>• <b>Application:</b> Drag chain operation, Zones with oils and lubricants, Robot, Drag chain operation</li> </ul>	YF2A14-020UB3XLEAX	2095607
	<ul style="list-style-type: none"> <li>• <b>Description:</b> Sensor/actuator cable, unshielded</li> <li>• <b>Connection type head A:</b> Female connector, M12, 4-pin, straight, A-coded</li> <li>• <b>Connection type head B:</b> Flying leads</li> <li>• <b>Signal type:</b> Sensor/actuator cable</li> <li>• <b>Cable:</b> 5 m, 4-wire, PUR, halogen-free</li> <li>• <b>Application:</b> Drag chain operation, Zones with oils and lubricants, Robot, Drag chain operation</li> </ul>	YF2A14-050UB3XLEAX	2095608
	<ul style="list-style-type: none"> <li>• <b>Description:</b> Sensor/actuator cable, unshielded</li> <li>• <b>Connection type head A:</b> Female connector, M12, 4-pin, straight, A-coded</li> <li>• <b>Connection type head B:</b> Flying leads</li> <li>• <b>Signal type:</b> Sensor/actuator cable</li> <li>• <b>Cable:</b> 10 m, 4-wire, PUR, halogen-free</li> <li>• <b>Application:</b> Drag chain operation, Zones with oils and lubricants, Robot, Drag chain operation</li> </ul>	YF2A14-100UB3XLEAX	2095609
	<ul style="list-style-type: none"> <li>• <b>Description:</b> Sensor/actuator cable, unshielded</li> <li>• <b>Connection type head A:</b> Female connector, M12, 4-pin, straight, A-coded</li> <li>• <b>Connection type head B:</b> Flying leads</li> <li>• <b>Signal type:</b> Sensor/actuator cable</li> <li>• <b>Cable:</b> 20 m, 4-wire, PUR, halogen-free</li> <li>• <b>Application:</b> Drag chain operation, Zones with oils and lubricants, Robot, Drag chain operation</li> </ul>	YF2A14-200UB3XLEAX	2095611
	<ul style="list-style-type: none"> <li>• <b>Description:</b> Sensor/actuator cable, unshielded</li> <li>• <b>Connection type head A:</b> Female connector, M12, 4-pin, straight, A-coded</li> <li>• <b>Connection type head B:</b> Flying leads</li> <li>• <b>Signal type:</b> Sensor/actuator cable</li> <li>• <b>Cable:</b> 0.6 m, 4-wire, PUR, halogen-free</li> </ul>	YF2A14-C60UB3XLEAX	2145654

	Brief description	Type	part no.
	<ul style="list-style-type: none"> <li><b>Application:</b> Drag chain operation, Zones with oils and lubricants, Robot, Drag chain operation</li> <li><b>Description:</b> Sensor/actuator cable, unshielded</li> <li><b>Connection type head A:</b> Female connector, M12, 4-pin, straight, A-coded</li> <li><b>Connection type head B:</b> Flying leads</li> <li><b>Signal type:</b> Sensor/actuator cable</li> <li><b>Cable:</b> 1 m, 4-wire, PUR, halogen-free</li> <li><b>Application:</b> Drag chain operation, Zones with oils and lubricants, Robot, Drag chain operation</li> </ul>	YF2A14-010UB3XLEAX	2145655
	<ul style="list-style-type: none"> <li><b>Description:</b> Sensor/actuator cable, unshielded</li> <li><b>Connection type head A:</b> Female connector, M12, 4-pin, straight, A-coded</li> <li><b>Connection type head B:</b> Flying leads</li> <li><b>Signal type:</b> Sensor/actuator cable</li> <li><b>Cable:</b> 3 m, 4-wire, PUR, halogen-free</li> <li><b>Application:</b> Drag chain operation, Zones with oils and lubricants, Robot, Drag chain operation</li> </ul>	YF2A14-030UB3XLEAX	2145656
	<ul style="list-style-type: none"> <li><b>Description:</b> Sensor/actuator cable, unshielded</li> <li><b>Connection type head A:</b> Female connector, M12, 4-pin, angled, A-coded</li> <li><b>Connection type head B:</b> Flying leads</li> <li><b>Signal type:</b> Sensor/actuator cable</li> <li><b>Cable:</b> 0.6 m, 4-wire, PUR, halogen-free</li> <li><b>Application:</b> Drag chain operation, Zones with oils and lubricants, Robot, Drag chain operation</li> </ul>	YG2A14-C60UB3XLEAX	2145657
	<ul style="list-style-type: none"> <li><b>Description:</b> Sensor/actuator cable, unshielded</li> <li><b>Connection type head A:</b> Female connector, M12, 4-pin, angled, A-coded</li> <li><b>Connection type head B:</b> Flying leads</li> <li><b>Signal type:</b> Sensor/actuator cable</li> <li><b>Cable:</b> 1 m, 4-wire, PUR, halogen-free</li> <li><b>Application:</b> Drag chain operation, Zones with oils and lubricants, Robot, Drag chain operation</li> </ul>	YG2A14-010UB3XLEAX	2145658

## SICK AT A GLANCE

SICK is one of the leading manufacturers of intelligent sensors and sensor solutions for industrial applications. A unique range of products and services creates the perfect basis for controlling processes securely and efficiently, protecting individuals from accidents and preventing damage to the environment.

We have extensive experience in a wide range of industries and understand their processes and requirements. With intelligent sensors, we can deliver exactly what our customers need. In application centers in Europe, Asia and North America, system solutions are tested and optimized in accordance with customer specifications. All this makes us a reliable supplier and development partner.

Comprehensive services complete our offering: SICK LifeTime Services provide support throughout the machine life cycle and ensure safety and productivity.

For us, that is “Sensor Intelligence.”

## WORLDWIDE PRESENCE:

Contacts and other locations –[www.sick.com](http://www.sick.com)