



IME2S12-04N4DQ9

IME2S

NON-CONTACT SAFETY SWITCHES

SICK
Sensor Intelligence.



Ordering information

Type	part no.
IME2S12-04N4DQ9	1091943

Other models and accessories → www.sick.com/IME2S



Detailed technical data

Features

Sensor principle	Inductive
Number of safe outputs	2
Housing diameter	M12
Sensing range S_n	4 mm ¹⁾
Assured switch on distance S_{ao}	3.2 mm ¹⁾
Assured switch off distance S_{ar}	6 mm ¹⁾
Active sensor surfaces	1
Actuation frequency	≤ 100 Hz
Items supplied	Including mounting nuts, brass, nickel-plated (2x)

¹⁾ Values apply for steel (FE360).

Safety-related parameters

Safety integrity level	SIL 2 (IEC 61508)
Category	Category 2 (ISO 13849-1)
Performance level	PL d (ISO 13849-1)
PFH_D (mean probability of a dangerous failure per hour)	6.0×10^{-8} ¹⁾
T_M (mission time)	20 years (ISO 13849-1)
Type	Type 3 (ISO 14119-1)
Actuator coding level	Uncoded (EN ISO 14119)
Safe state in the event of a fault	At least one safety-related semiconductor output (OSSD) is in the OFF state.

¹⁾ At 40 °C and 1000 m above sea level.

Functions

Safe series connection	With Flexi Loop (with diagnostics)
-------------------------------	------------------------------------

Interfaces

Connection type	Cable with M12 male connector, 4-pin
Length of cable	0.3 m

Cable diameter	3.9 mm
Conductor cross section	0.25 mm ²
Bend radius (with fixed installation)	> 6 x cable diameter
Bend radius (with moving cable)	> 10 x cable diameter
Cable material	PVC
Conductor material	Copper
Coupling nut material	Nickel-plated brass
Display elements	LEDs
Diagnostics indicator	✓
Status display	✓

Electronics

Protection class	III (IEC 61140)
Rated insulation voltage U_i	28.8 V
Rated impulse withstand voltage U_{imp}	1,500 V
Supply voltage V_s	24 V DC (19.2 V DC ... 28.8 V DC)
Power consumption	≤ 20 mA
Type of output	Self-monitoring semiconductor outputs (OSSDs)
Response time	≤ 1 ms
Release time	≤ 1 ms
Risk time	≤ 20 ms
Switch-on time	1 s

Mechanics

Design	Cylindrical
Housing diameter	M12
Housing length	63 mm
Thread length	36.9 mm
Material	
Housing	Nickel-plated brass
Sensor surface	VISTAL®
Cable	PVC
Installation type	Non-flush

Ambient data

Enclosure rating	IP67 (IEC 60529)
Ambient operating temperature	-25 °C ... +70 °C
Storage temperature	-25 °C ... +70 °C
Relative humidity	50 %, at 70 °C (IEC 60947-5-2)
Vibration resistance	10 Hz ... 55 Hz, 1 mm (IEC 60947-5-2)
EMC	IEC 60947-5-2 IEC 60947-5-3 IEC 61000-6-7

Certificates

EU declaration of conformity	✓
-------------------------------------	---

UK declaration of conformity	✓
ACMA declaration of conformity	✓
Moroccan declaration of conformity	✓
China RoHS	✓
UK-Type-Examination approval	✓
cULus certificate	✓
EC-Type-Examination approval	✓
Third party certificate	✓

Classifications

ECLASS 5.0	27272401
ECLASS 5.1.4	27272401
ECLASS 6.0	27272401
ECLASS 6.2	27272401
ECLASS 7.0	27272401
ECLASS 8.0	27272401
ECLASS 8.1	27272401
ECLASS 9.0	27272401
ECLASS 10.0	27272401
ECLASS 11.0	27272401
ECLASS 12.0	27274101
ETIM 5.0	EC001818
ETIM 6.0	EC001818
ETIM 7.0	EC001818
ETIM 8.0	EC001818
UNSPSC 16.0901	39122205

Dimensional drawing

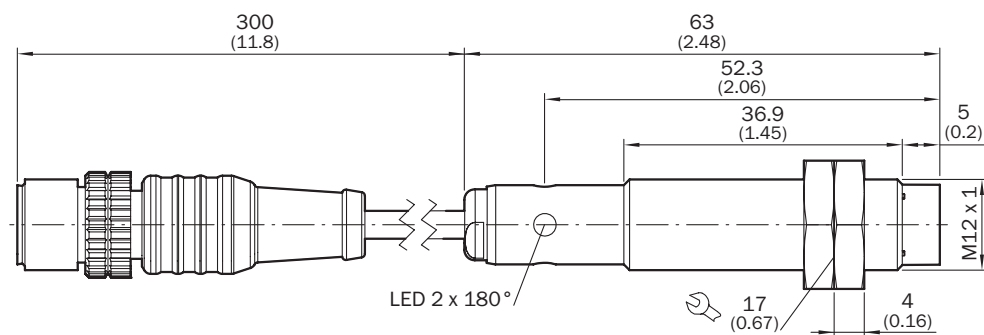

Dimensions in mm (inch)

Response range

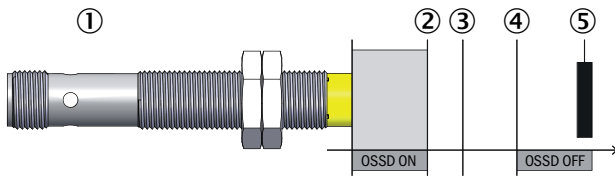

- ① safety switch
- ② assured switch on distance S_{ao}
- ③ Sensing range S_n
- ④ assured switch off distance S_{ar}
- ⑤ actuator

Pinouts

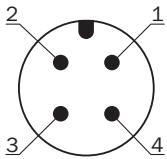







Pin	Designation	Description
1	+24 V DC	24 V DC voltage supply
2	OSSD 1	OSSD 1 output
3	0 V DC	0 V DC voltage supply
4	OSSD 2	OSSD 2 output

For details see operating instructions

Recommended accessories

Other models and accessories → www.sick.com/IME2S

	Brief description	Type	part no.
connectors and cables			
	<ul style="list-style-type: none"> Description: Sensor/actuator cable, unshielded Connection type head A: Female connector, M12, 4-pin, straight, A-coded Connection type head B: Flying leads Signal type: Sensor/actuator cable Cable: 5 m, 4-wire, PVC Application: Untaminated zones, Zones with chemicals 	YF2A14-050VB3XLEAX	2096235
	<ul style="list-style-type: none"> Description: Sensor/actuator cable, unshielded Connection type head A: Female connector, M12, 4-pin, straight, A-coded Connection type head B: Flying leads Signal type: Sensor/actuator cable Cable: 10 m, 4-wire, PVC Application: Untaminated zones, Zones with chemicals 	YF2A14-100VB3XLEAX	2096236
	<ul style="list-style-type: none"> Description: Sensor/actuator cable, unshielded Connection type head A: Female connector, M12, 4-pin, straight, A-coded Connection type head B: Flying leads Signal type: Sensor/actuator cable Cable: 15 m, 4-wire, PVC Application: Untaminated zones, Zones with chemicals 	YF2A14-150VB3XLEAX	2096237
	<ul style="list-style-type: none"> Description: Sensor/actuator cable, unshielded Connection type head A: Female connector, M12, 4-pin, straight, A-coded Connection type head B: Flying leads Signal type: Sensor/actuator cable Cable: 20 m, 4-wire, PVC Application: Untaminated zones, Zones with chemicals 	YF2A14-200VB3XLEAX	2096238
Mounting systems			
	<ul style="list-style-type: none"> Description: Mounting bracket for M12 sensors Material: Steel Details: Steel, zinc coated Items supplied: Without mounting hardware 	BEF-WN-M12	5308447
	<ul style="list-style-type: none"> Description: Clamping block for round sensors M12, without fixed stop Material: Plastic Details: Plastic (PA12), glass-fiber reinforced Items supplied: Mounting hardware included 	BEF-KH-M12	2051479

SICK AT A GLANCE

SICK is one of the leading manufacturers of intelligent sensors and sensor solutions for industrial applications. A unique range of products and services creates the perfect basis for controlling processes securely and efficiently, protecting individuals from accidents and preventing damage to the environment.

We have extensive experience in a wide range of industries and understand their processes and requirements. With intelligent sensors, we can deliver exactly what our customers need. In application centers in Europe, Asia and North America, system solutions are tested and optimized in accordance with customer specifications. All this makes us a reliable supplier and development partner.

Comprehensive services complete our offering: SICK LifeTime Services provide support throughout the machine life cycle and ensure safety and productivity.

For us, that is “Sensor Intelligence.”

WORLDWIDE PRESENCE:

Contacts and other locations –www.sick.com