



LBC642

Label Checker

QUALITY CONTROL SYSTEMS

SICK
Sensor Intelligence.



Ordering information

Type	part no.
LBC642	1091687

Other models and accessories → www.sick.com/Label_Checker

Illustration may differ



Detailed technical data

Features

Technology	2D snapshot
Light source	Illumination LEDs: (to be ordered separately as accessories) Laser alignment aid: visible red light ($\lambda = 630 \text{ nm} \dots 680 \text{ nm}$)
Laser class	1, complies with 21 CFR 1040.10 except for the conformance according to "Laser Notice No. 50" from June 24, 2007 (IEC 60825-1:2014, EN 60825-1:2014)
Focus	Adjustable focus (manually)
Sensor	CMOS matrix sensor, grayscale values, 1.7 Mpixel, 1,600 px, 1,088 px
Spectral range	Approx. 400 nm ... 900 nm
Lens	C-mount

Mechanics/electronics

Dimensions, system (L x W x H)	142 mm x 90 mm x 46 mm (Housing only, without lens and optics protection hood)
Enclosure rating	IP65 (EN 60529 (1991-10), EN 60529/A2 (2002-02))
Protection class	III (EN 60950-1 (2014-08))
Power consumption	Typ. 10 W, $\pm 20 \%$
Housing material	Aluminum die cast
Output current	$\leq 100 \text{ mA}$
Connections	1 x M12, 17-pin male connector (serial, I/Os, voltage supply) 1 x M8, 4-pin female connector (USB, not used) 2 x M12, 8-pin female connector (Gigabit Ethernet, only one connection used)
Supply voltage	24 V DC, $\pm 20 \%$
Window material	Glass
Weight	635 g

Performance

Bar code types	2/5 Industrial Interleaved 2 of 5 Codabar Code 39 Code 93 Code 128 EAN-8 EAN13 Pharmacode
-----------------------	---

2D code types	Data Matrix ECC200 QR code Micro QR code PDF417 Aztec
OCR/OCV fonts	Universal, industrial, document, DotPrint, pharma, OCR-A, OCR-B, Arabic numbers
Optical format	1"
Maximum encoder frequency	1 kHz

Interfaces

Ethernet	✓ , TCP/IP
Function	EtherNet/IP UDP / PROFINET FTP HTTP
Data transmission rate	10/100/1,000 Mbit/s
Operator interface	Web server
Optical indicators	10 x status display, 10 x LED bar graph, 1 green feedback spot
Data storage and retrieval	Image and data logging via microSD memory card and external FTP
Acoustic indicators	Beeper

Ambient data

Ambient temperature, operation	-20 °C ... +70 °C, permissible relative humidity: 0% ... 90% (non-condensing)
Ambient temperature, storage	-20 °C ... +70 °C ¹⁾
Shock load	EN 60068-2-27:2009-05
Vibration load	EN 60068-2-6:2008-02

¹⁾ Permissible relative humidity: 0% ... 90% (non-condensing).

General notes

Items supplied	InspectorP V2D642P LabelChecker software
-----------------------	---

Certificates

EU declaration of conformity	✓
UK declaration of conformity	✓

Classifications

ECLASS 5.0	27310205
ECLASS 5.1.4	27310205
ECLASS 6.0	27310205
ECLASS 6.2	27310205
ECLASS 7.0	27310205
ECLASS 8.0	27310205
ECLASS 8.1	27310205
ECLASS 9.0	27310205
ECLASS 10.0	27289090
ECLASS 11.0	27289090
ECLASS 12.0	27289090

ETIM 5.0	EC001820
ETIM 6.0	EC001820
ETIM 7.0	EC001820
ETIM 8.0	EC001820
UNSPSC 16.0901	43211731

Dimensional drawing

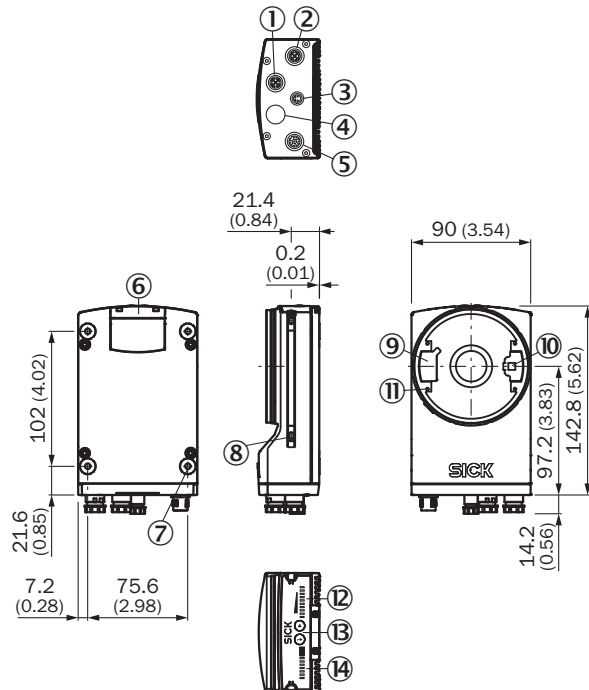

Dimensions in mm (inch)

- ① "Ethernet" P1 connection
- ② P3 connection "Ethernet"
- ③ X2 "USB" connection or "trigger external lighting", depending on type
- ④ P2 connection "CAN OUT", depending on type
- ⑤ X1 "Power/Serial Data/CAN/I/O" connection or "CAN IN", depending on type
- ⑥ cover for the microSD memory card
- ⑦ M5 blind tapped holes, 5 mm deep (4 x), for mounting the sensor
- ⑧ sliding nut M5, 5.5 mm deep (2 x), for mounting (as alternative)
- ⑨ plug connector for connecting the integrated lighting
- ⑩ laser alignment aid exit
- ⑪ 2.5 mm blind tapped holes (4 x) for mounting the spacers for the integrable illumination
- ⑫ Bar graph display
- ⑬ Function button (2 x)
- ⑭ LED for status display (2 levels), 10 x

Characteristic curve

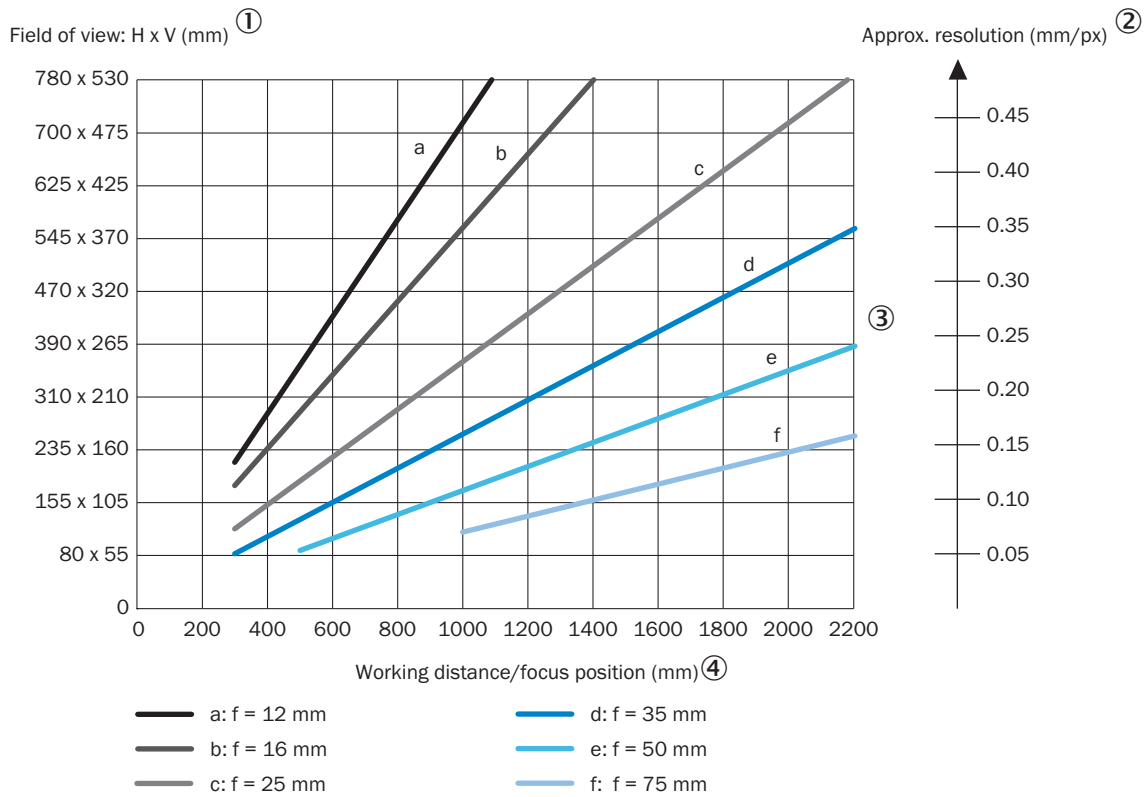





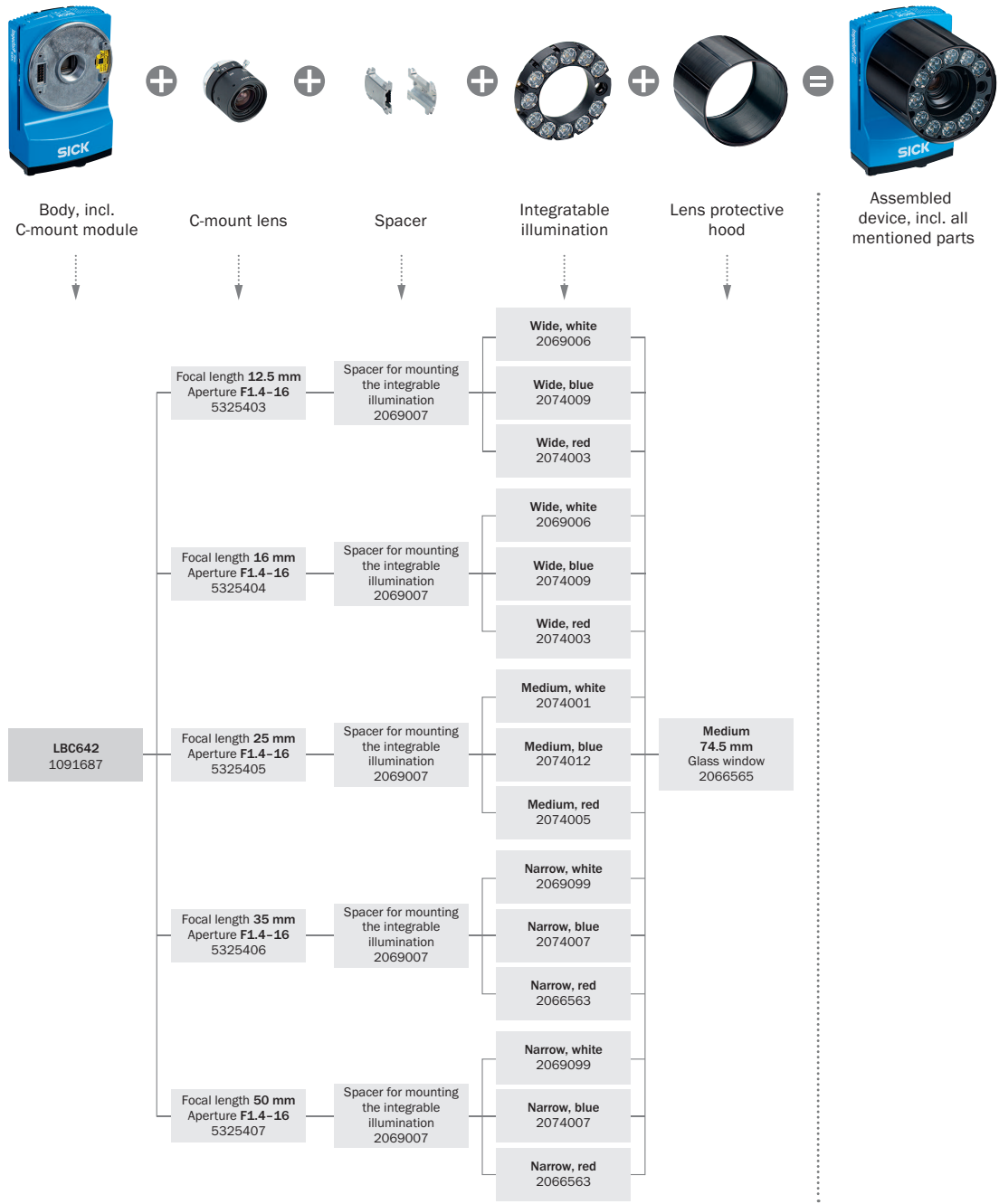

- ① Field of view: Horizontal x vertical in mm
- ② approximate resolution in mm/px
- ③ Lens focal length
- ④ Working distance/Focus position in mm

Selection Guide



Recommended accessories

Other models and accessories → www.sick.com/Label_Checker

	Brief description	Type	part no.
reflectors and optics			
	<ul style="list-style-type: none"> Description: Optics protection hood, enclosure rating IP 65, length: 74.5 mm, glass window 	Protective cover for optics	2066565
	<ul style="list-style-type: none"> Description: Integratable lighting, lighting color white, medium, suitable for lenses with a focal length of 25 mm 	VI83I-WH1441MO	2074001
	<ul style="list-style-type: none"> Description: C-mount 1/1.8", focal length 25 mm, aperture 1.4 – 16 Dimensions: 35 mm Without C-mount thread 	C-mount lens	5325405
	<ul style="list-style-type: none"> Description: Spacer for mounting the integratable illumination, length: 51.3 mm 	Spacer	2069007
Mounting systems			
	<ul style="list-style-type: none"> Description: Mounting bracket kit comprising mounting bracket, cooling plate and screws, including angle indicator for adjusting the tilt angle 	Mounting bracket kit	2069171
	<ul style="list-style-type: none"> Description: Sliding nut, M5, short Usable for: Lector62x, EventCam 	Sliding nut	5324896
connectors and cables			
	<ul style="list-style-type: none"> Connection type head A: Female connector, M12, 17-pin, straight, A-coded Connection type head B: Flying leads Signal type: Power, serial, CAN, digital I/Os Cable: 3 m, 17-wire, stripped, PE-X Description: Power, suitable for 2 A, shielded, Serial, Changed color coding of the flying leads, CAN, Digital I/Os Connection systems: Flying leads Note: Max. permissible current strength at ambient temperature 50 °C: Contact 1 (blue) and contact 2 (brown): 3 A while the remaining contacts are operated with max. 100 mA; max. permissible current strength at ambient temperature 40 °C: 2 A for two and 1.5 A for 15 contacts. Application: Drag chain operation 	YF2ASD-030XXXLECX	2070425

SICK AT A GLANCE

SICK is one of the leading manufacturers of intelligent sensors and sensor solutions for industrial applications. A unique range of products and services creates the perfect basis for controlling processes securely and efficiently, protecting individuals from accidents and preventing damage to the environment.

We have extensive experience in a wide range of industries and understand their processes and requirements. With intelligent sensors, we can deliver exactly what our customers need. In application centers in Europe, Asia and North America, system solutions are tested and optimized in accordance with customer specifications. All this makes us a reliable supplier and development partner.

Comprehensive services complete our offering: SICK LifeTime Services provide support throughout the machine life cycle and ensure safety and productivity.

For us, that is “Sensor Intelligence.”

WORLDWIDE PRESENCE:

Contacts and other locations –www.sick.com