



V3T11P-MR12A7

TriSpector1000

3D MACHINE VISION

SICK
Sensor Intelligence.



Ordering information

Type	part no.
V3T11P-MR12A7	1091322

Other models and accessories → www.sick.com/TriSpector1000



Detailed technical data

Features

Technology	3D laser triangulation
Programmable	✓
Pre-calibrated	✓
Toolkit	SICK algorithm API HALCON
Working range	56 mm ... 116 mm
Example field of view	65 mm x 15 mm
Illumination	Integrated
Illumination color	Red, laser, Visible, 660 nm, ± 7 nm
Laser class	2 (EN 60825-1:2014+A11:2021; IEC 60825-1:2014, Complies with the FDA performance requirements for laser products except for conformance with IEC 60825-1 Ed.3., as described in Laser Notice 56 dated May 8, 2019.)
Width at minimum operating distance	40 mm
Width at maximum operating distance	75 mm
Maximum height range	60 mm
Imaging angle	65°
Offline support	Emulator
Task	Detecting - Standard objects Detecting - Level Measuring - Dimension, contour and volume Measuring - Number Monitoring and controlling - Quality Determining position - 3D position determination

Mechanics/electronics

Connector material	Nickel plated brass
Supply voltage	24 V DC, ± 20 %
Ripple	< 5 V _{pp}
Power consumption	≤ 11 W
Current consumption	≤ < 450 mA

	Without output load
Enclosure rating	IP67
Protection class	III
Housing material	Anodized aluminum
Window material	Glass
Weight	0.9 kg
Dimensions (L x W x H)	136 mm x 62 mm x 84 mm

Performance

Scan/frame rate	5,000 3D profiles/s
Maximum number of profiles	2,500 Per image
Data points/profile	1,536
Height resolution	20 µm ... 50 µm
3D profile resolution	0.049 mm/px

Interfaces

Ethernet	✓ , TCP/IP
Function	FTP, HTTP
Data transmission rate	≤ 1,000 Mbit/s
Serial	✓ , RS-232, RS-422
Operator interfaces	Web server
Configuration software	SICK AppStudio
Digital input	3 inputs
Configurable outputs	4 inputs/outputs
Encoder interface	RS-422 / TTL
Maximum encoder frequency	Max. 300 kHz

Ambient data

Electromagnetic compatibility (EMC)	EN 61000-6-2:2005 / EN 61000-6-3:2007
Shock load	15 g / 6 ms (EN 60068-2-27)
Vibration load	5 g, 10 Hz ... 150 Hz (EN 60068-2-6)
Ambient operating temperature	0 °C ... +45 °C
Storage temperature	-20 °C ... +70 °C ¹⁾

¹⁾ Permissible relative humidity: 0% ... 90% (non-condensing).

Certificates

EU declaration of conformity	✓
UK declaration of conformity	✓
ACMA declaration of conformity	✓
China RoHS	✓
cTUVus certificate	✓
Information according to Art. 3 of Data Act (Regulation EU 2023/2854)	✓

Classifications

ECLASS 5.0	27310205
-------------------	----------

ECLASS 5.1.4	27310205
ECLASS 6.0	27310205
ECLASS 6.2	27310205
ECLASS 7.0	27310205
ECLASS 8.0	27310205
ECLASS 8.1	27310205
ECLASS 9.0	27310205
ECLASS 10.0	27310205
ECLASS 11.0	27310205
ECLASS 12.0	27310205
ETIM 5.0	EC001820
ETIM 6.0	EC001820
ETIM 7.0	EC001820
ETIM 8.0	EC001820
UNSPSC 16.0901	43211731

Dimensional drawing

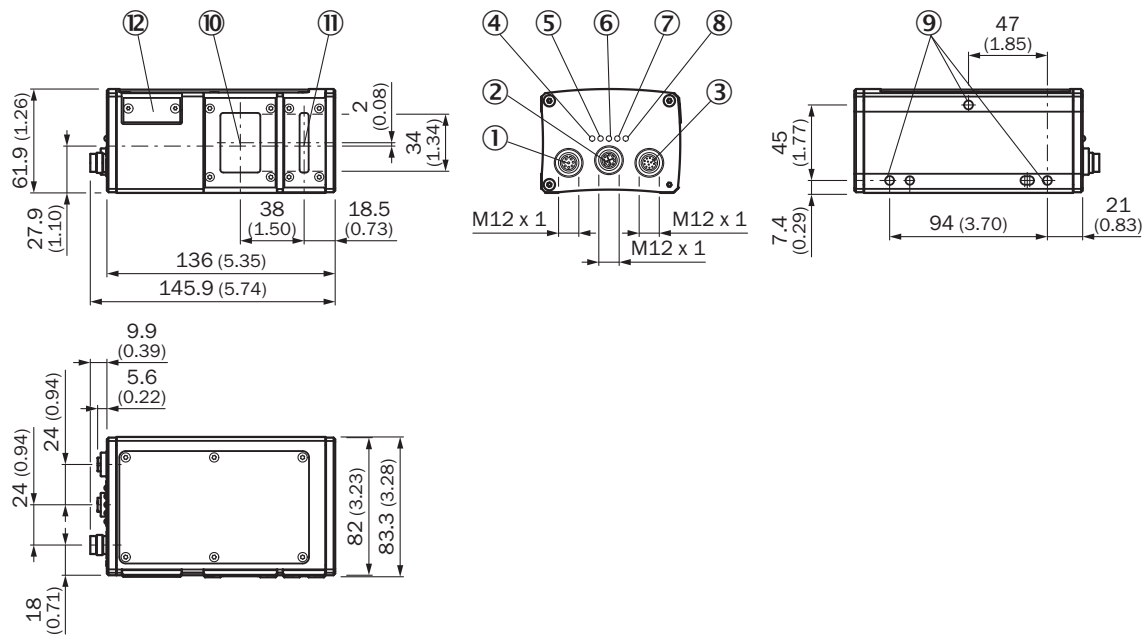

Dimensions in mm (inch)

- ① Connector Encoder (thread inside)
- ② Gigabit Ethernet connection (GbE)
- ③ Connector Power I/O (thread inside)
- ④ LED; On
- ⑤ LED; State
- ⑥ LED; Link/Data
- ⑦ LED; Result
- ⑧ LED; Laser
- ⑨ Fastening threads (M5 x 8.5 mm length)
- ⑩ Optical receiver (center)
- ⑪ Optical sender (center)

📄 Micro SD memory card

Field of view

TriSpectorP1008

Typ. field of view in mm (Inch)

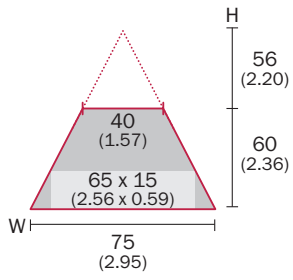

Field of view

Typical field of view

TriSpectorP1000

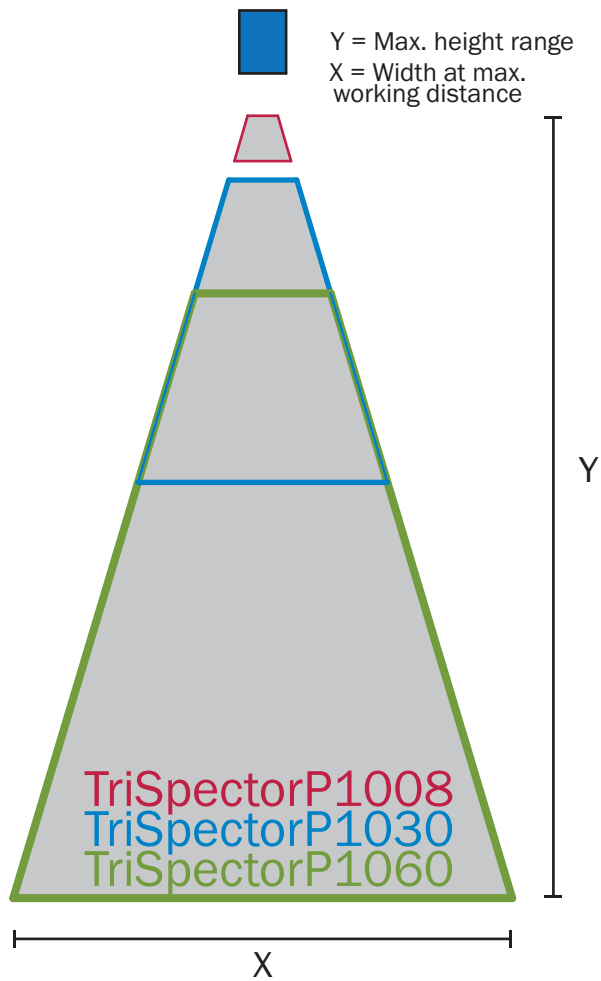



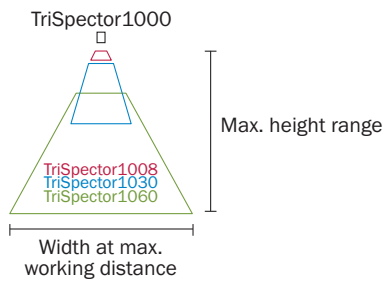

Field of view

Typical field of view



Recommended accessories

Other models and accessories → www.sick.com/TriSpector1000

	Brief description	Type	part no.
Mounting systems			
	<ul style="list-style-type: none"> Description: Mounting bracket set consisting of mounting bracket, cooling plate, includes angle display for setting the tilt angle Suitable for: Lector63x, Inspector63x, Lector83x – up to 40 °C ambient operating temperature, Insepector83x – up to 40 °C ambient operating temperature, Lector83x – up to 40 °C ambient operating temperature, Insepector83x – up to 40 °C ambient operating temperature, Lector63x, Insepector63x 	Mounting bracket set with inclination angle -40° - 40°	2076735
connectors and cables			
	<ul style="list-style-type: none"> Description: Sensor/actuator cable, shielded Connection type head A: Female connector, M12, 8-pin, straight, A-coded Connection type head B: Male connector, M12, 8-pin, straight, A-coded Signal type: Sensor/actuator cable Cable: 2 m, 8-wire, PUR, halogen-free Application: Drag chain operation, Zones with oils and lubricants, Robot, Drag chain operation 	YF2A28-020UA6M2A28	2096105
	<ul style="list-style-type: none"> Description: Power, shielded, Digital I/Os, Serial Connection type head A: Female connector, M12, 12-pin, straight Connection type head B: Male connector, M12, 17-pin, straight Signal type: Power, digital I/Os, serial Cable: 0.25 m 	YF2AAB-C25S01M2AAD	2086398
	<ul style="list-style-type: none"> Description: Shielded Connection type head A: Male connector, M12, 5-pin, straight Connection type head B: Flying leads Cable: 2 m Connection systems: Flying leads 	Connecting cable	6024860
	<ul style="list-style-type: none"> Description: Power Connection type head A: Female connector, M12, 12-pin, straight Connection type head B: Male connector, M12, 5-pin, straight Signal type: Power Cable: 0.25 m 	YF2A6B-C25XXM2A15	2079766
	<ul style="list-style-type: none"> Description: Sensor/actuator cable, shielded Connection type head A: Male connector, M12, 8-pin, straight, A-coded Connection type head B: Flying leads Signal type: Sensor/actuator cable Cable: 5 m, 8-wire, PVC Application: Uncontaminated zones, Zones with chemicals 	YM2A28-050VA6XLEAX	2096233
	<ul style="list-style-type: none"> Connection type head A: Male connector, M12, 8-pin, straight, X-coded Connection type head B: Male connector, RJ45, 8-pin, straight Signal type: Ethernet, Gigabit Ethernet Cable: 2 m, 8-wire, PUR, halogen-free Description: Ethernet, shielded, Gigabit Ethernet Application: Zones with oils and lubricants 	YM2X18-020EG1M-RJA8	2106258
	<ul style="list-style-type: none"> Connection type head A: Male connector, M12, 8-pin, straight, X-coded Connection type head B: Male connector, RJ45, 8-pin, straight Signal type: Ethernet, Gigabit Ethernet Cable: 3 m, 8-wire, PUR, halogen-free Description: Ethernet, shielded, Gigabit Ethernet Application: Zones with oils and lubricants 	YM2X18-030EG1M-RJA8	2145693

SICK AT A GLANCE

SICK is one of the leading manufacturers of intelligent sensors and sensor solutions for industrial applications. A unique range of products and services creates the perfect basis for controlling processes securely and efficiently, protecting individuals from accidents and preventing damage to the environment.

We have extensive experience in a wide range of industries and understand their processes and requirements. With intelligent sensors, we can deliver exactly what our customers need. In application centers in Europe, Asia and North America, system solutions are tested and optimized in accordance with customer specifications. All this makes us a reliable supplier and development partner.

Comprehensive services complete our offering: SICK LifeTime Services provide support throughout the machine life cycle and ensure safety and productivity.

For us, that is “Sensor Intelligence.”

WORLDWIDE PRESENCE:

Contacts and other locations –www.sick.com