



DFS60I-BGPC65536

DFS60

INCREMENTAL ENCODERS

SICK
Sensor Intelligence.



Ordering information

| Type | part no. |
|------------------|----------|
| DFS60I-BGPC65536 | 1089962 |

Other models and accessories → www.sick.com/DFS60

Illustration may differ



Detailed technical data

Safety-related parameters

| | |
|--|--|
| MTTF_D (mean time to dangerous failure) | 300 years (EN ISO 13849-1) ¹⁾ |
|--|--|

¹⁾ This product is a standard product and does not constitute a safety component as defined in the Machinery Directive. Calculation based on nominal load of components, average ambient temperature 40°C, frequency of use 8760 h/a. All electronic failures are considered hazardous. For more information, see document no. 8015532.

Performance

| | |
|---|-------------------------------------|
| Pulses per revolution | 65,536 ¹⁾ |
| Measuring step | 90°, electric/pulses per revolution |
| Measuring step deviation at binary number of lines | ± 0.0015° |
| Error limits | ± 0.03° |

¹⁾ See maximum revolution range.

Interfaces

| | |
|---------------------------------------|-----------------------------------|
| Communication interface | Incremental |
| Communication Interface detail | TTL / HTL |
| Factory setting | Factory setting: output level TTL |
| Number of signal channels | 6-channel |
| Programmable/configurable | ✓ |
| Initialization time | 32 ms, 30 ms ¹⁾ |
| Output frequency | ≤ 820 kHz |
| Load current | ≤ 30 mA |
| Operating current | 40 mA (without load) |
| Power consumption | ≤ 0.7 W (without load) |
| Load resistance | ≥ 120 Ω |

¹⁾ With mechanical zero pulse width.

Electronics

| | |
|--|---|
| Connection type | Male connector, M12, 8-pin, radial |
| Supply voltage | 4.5 ... 32 V |
| Reference signal, number | 1 |
| Reference signal, position | 90°, electric, logically gated with A and B |
| Reverse polarity protection | ✓ |
| Short-circuit protection of the outputs | ✓ ^{1) 2)} |

¹⁾ Programming TTL with ≥ 5.5 V: short-circuit opposite to another channel or GND permissible for maximum 30 s.

²⁾ Programming HTL or TTL with < 5.5 V: short-circuit opposite to another channel, US or GND permissible for maximum 30 s.

Mechanics

| | |
|---------------------------------------|---|
| Mechanical design | Blind hollow shaft |
| Shaft diameter | 14 mm Front clamp |
| Weight | + 0.5 kg |
| Shaft material | Stainless steel V2A |
| Flange material | Stainless steel V2A |
| Housing material | Stainless steel V2A |
| Start up torque | 1 Ncm (+20 °C) |
| Operating torque | 0.5 Ncm (+20 °C) |
| Permissible movement static | ± 0.3 mm (radial) ± 0.5 mm (axial) |
| Permissible movement dynamic | ± 0.05 mm (radial) ± 0.01 mm (axial) |
| Operating speed | $\leq 6,000$ min ⁻¹ ¹⁾ |
| Moment of inertia of the rotor | 40 gcm ² |
| Bearing lifetime | 3.6×10^{10} revolutions |
| Angular acceleration | $\leq 500,000$ rad/s ² |

¹⁾ Allow for self-heating of 3.3 K per 1,000 rpm when designing the operating temperature range.

Ambient data

| | |
|--------------------------------------|--|
| EMC | According to EN 61000-6-2 and EN 61000-6-3 |
| Enclosure rating | IP67, housing side (IEC 60529) ¹⁾ IP67, shaft side (IEC 60529) |
| Permissible relative humidity | 90 % (Condensation not permitted) |
| Operating temperature range | -40 °C ... +100 °C ²⁾ -30 °C ... +100 °C ³⁾ |
| Storage temperature range | -40 °C ... +100 °C, without package |
| Resistance to shocks | 100 g, 6 ms (EN 60068-2-27) |
| Resistance to vibration | 10 g, 10 Hz ... 2,000 Hz (EN 60068-2-6) |

¹⁾ With mating connector fitted.

²⁾ Stationary position of the cable.

³⁾ Flexible position of the cable.

Certificates

| | |
|-------------------------------------|---|
| EU declaration of conformity | ✓ |
|-------------------------------------|---|

| | |
|--|---|
| UK declaration of conformity | ✓ |
| ACMA declaration of conformity | ✓ |
| Moroccan declaration of conformity | ✓ |
| China RoHS | ✓ |
| cULus certificate | ✓ |
| Information according to Art. 3 of Data Act (Regulation EU 2023/2854) | ✓ |

Classifications

| | |
|-----------------------|----------|
| ECLASS 5.0 | 27270501 |
| ECLASS 5.1.4 | 27270501 |
| ECLASS 6.0 | 27270590 |
| ECLASS 6.2 | 27270590 |
| ECLASS 7.0 | 27270501 |
| ECLASS 8.0 | 27270501 |
| ECLASS 8.1 | 27270501 |
| ECLASS 9.0 | 27270501 |
| ECLASS 10.0 | 27270501 |
| ECLASS 11.0 | 27270501 |
| ECLASS 12.0 | 27270501 |
| ETIM 5.0 | EC001486 |
| ETIM 6.0 | EC001486 |
| ETIM 7.0 | EC001486 |
| ETIM 8.0 | EC001486 |
| UNSPSC 16.0901 | 41112113 |

Dimensional drawing

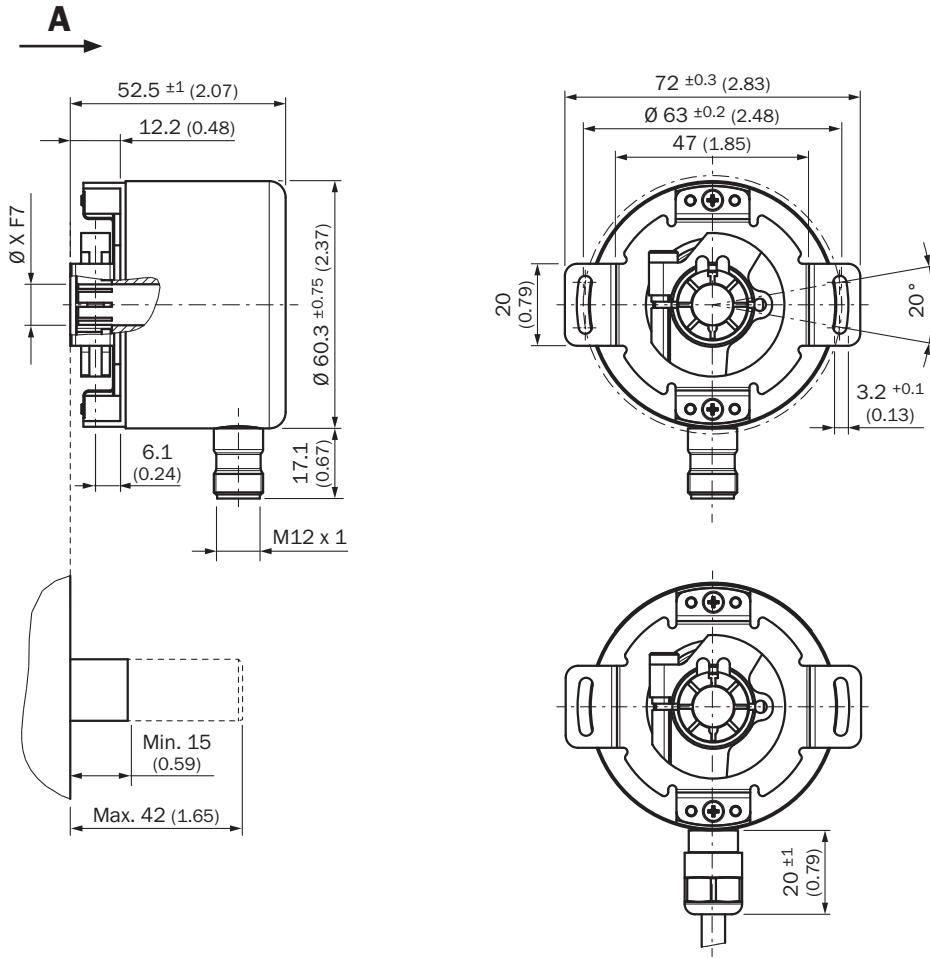

Dimensions in mm (inch)

PIN assignment

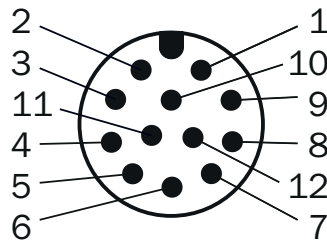
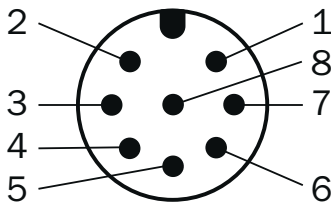

view of M12 male device connector on encoder

| Male connector M12, 8-pin | Connector M12, 12-pin | Wire colors (cable connection) | TTL/HTL signal | Sin/Cos 1.0 V _{PP} | Explanation |
|---------------------------|-----------------------|--------------------------------|----------------|-----------------------------|-------------|
| 1 | 7 | Brown | \bar{A} | COS- | Signal wire |
| 2 | 6 | White | A | COS+ | Signal wire |
| 3 | 9 | Black | \bar{B} | SIN- | Signal wire |

| Male connector M12, 8-pin | Connector M12, 12-pin | Wire colors (cable connection) | TTL/HTL signal | Sin/Cos 1.0 V _{pp} | Explanation |
|---------------------------|-----------------------|--------------------------------|---------------------|-----------------------------|---|
| 4 | 8 | Pink | B | SIN+ | Signal wire |
| 5 | 4 | Yellow | Z | Z | Signal wire |
| 6 | 11 | Purple | Z | Z | Signal wire |
| 7 | 12 | Blue | GND | GND | Ground connection |
| 8 | 5 | Red | +U _S | +U _S | Supply voltage |
| - | 2 | - | N.c. | N.c. | Not assigned |
| - | 3 | - | N.c. | N.c. | Not assigned |
| - | 1 | - | N.c. | N.c. | Not assigned |
| - | 10 ¹⁾ | - | 0-SET ¹⁾ | N.c. | Set zero pulse1) |
| Screen | Screen | Screen | Screen | Screen | Screen connected to housing on encoder side. Connected to ground on control side. |

maximum revolution range

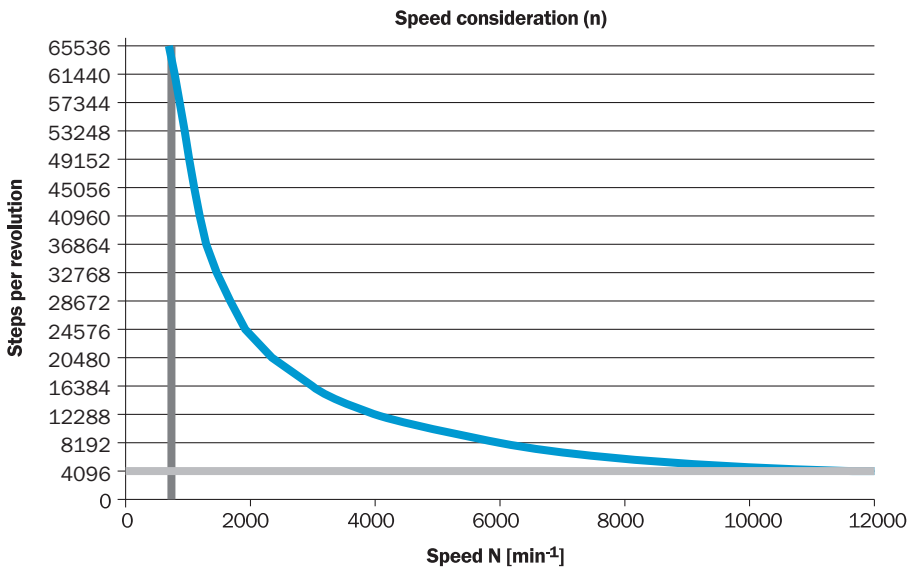

Diagrams Electrical zero pulse width can be configured to 90°, 180°, or 270°. Width of the zero pulse in relation to a pulse period.



Cw with view on the encoder shaft in direction "A", compare dimensional drawing.

| Supply voltage | Output |
|----------------|----------------------|
| 4,5 V ... 32 V | TTL/HTL programmable |



Diagrams Mechanical zero pulse width 1° to 359° programmable. Width of the zero pulse in relation to a mechanical revolution of the shaft.



| Supply voltage | Output |
|----------------|----------------------|
| 4,5 V ... 32 V | TTL/HTL programmable |

Recommended accessories

Other models and accessories → www.sick.com/DFS60

| | Brief description | Type | part no. |
|---|--|-------------|----------|
| Mounting systems | | | |
|  | <ul style="list-style-type: none"> Product family: Stator couplings Description: Standard stator coupling | BEF-DS00XFX | 2056812 |
| programming devices | | | |
|  | <ul style="list-style-type: none"> Product segment: Programming devices Product: PGT-10 Pro Description: Programming unit display for programmable SICK DFS60, DFV60, AFS/AFM60, AHS/AHM36 encoders, and wire draw encoder with DFS60, AFS/AFM60 and AHS/AHM36. Compact dimensions, low weight, and intuitive operation. Items supplied: 1 x PGT-10-Pro stand-alone programming tool, 4 x alkaline type batteries, 1.5 V Mignon (AA) | PGT-10-Pro | 1072254 |
|  | <ul style="list-style-type: none"> Product segment: Programming devices Product: PGT-08-S Description: USB programming unit, for programmable SICK encoders AFS60, AFM60, DFS60, VFS60, DFV60 and wire draw encoders with programmable encoders. Not compatible with the portable SOPAS ET versions. | PGT-08-S | 1036616 |

| | Brief description | Type | part no. |
|---|--|--------------------|----------|
| connectors and cables | | | |
|  | <ul style="list-style-type: none"> Description: Incremental, shielded, SSI Connection type head A: Female connector, M12, 8-pin, straight Connection type head B: Flying leads Signal type: Incremental, SSI Cable: 2 m, 8-wire, PUR, halogen-free Connection systems: Flying leads Application: Drag chain operation, Zones with oils and lubricants | DOL-1208-G02MAC1 | 6032866 |
|  | <ul style="list-style-type: none"> Description: Incremental, shielded, SSI Connection type head A: Female connector, M12, 8-pin, straight, A-coded Connection type head B: Flying leads Signal type: Incremental, SSI Cable: 2 m, 8-wire, PUR, halogen-free Connection systems: Flying leads | DOL-1208-G02MIE1 | 2120313 |
|  | <ul style="list-style-type: none"> Description: Incremental, shielded, SSI Connection type head A: Female connector, M12, 8-pin, straight Connection type head B: Flying leads Signal type: Incremental, SSI Cable: 5 m, 8-wire, PUR, halogen-free Connection systems: Flying leads Application: Drag chain operation, Zones with oils and lubricants | DOL-1208-G05MAC1 | 6032867 |
|  | <ul style="list-style-type: none"> Description: Incremental, shielded, SSI Connection type head A: Female connector, M12, 8-pin, straight Connection type head B: Flying leads Signal type: Incremental, SSI Cable: 10 m, 8-wire, PUR, halogen-free Connection systems: Flying leads Application: Drag chain operation, Zones with oils and lubricants | DOL-1208-G10MAC1 | 6032868 |
|  | <ul style="list-style-type: none"> Description: Incremental, shielded, SSI Connection type head A: Female connector, M12, 8-pin, straight Connection type head B: Flying leads Signal type: Incremental, SSI Cable: 20 m, 8-wire, PUR, halogen-free Connection systems: Flying leads Application: Drag chain operation, Zones with oils and lubricants | DOL-1208-G20MAC1 | 6032869 |
|  | <ul style="list-style-type: none"> Description: Incremental, shielded, SSI Connection type head A: Female connector, M12, 8-pin, straight Connection type head B: Flying leads Signal type: Incremental, SSI Cable: 25 m, 8-wire, PUR, halogen-free Connection systems: Flying leads Application: Drag chain operation, Zones with oils and lubricants | DOL-1208-G25MAC1 | 6067859 |
|  | <ul style="list-style-type: none"> Description: Shielded Connection type head A: Male connector, M12, 8-pin, straight, A-coded Connection systems: Screw-type terminals Permitted cross-section: ≤ 0.5 mm² Application: Hygienic and washdown zones | YM12ES8-0050S5586A | 2097337 |
|  | <ul style="list-style-type: none"> Description: Incremental, shielded, SSI Connection type head A: Female connector, M12, 8-pin, straight, A-coded Signal type: Incremental, SSI Cable: CAT5, CAT5e Connection systems: IDC quick connection Permitted cross-section: 0.14 mm² ... 0.34 mm² | DOS-1208-GA01 | 6045001 |
|  | <ul style="list-style-type: none"> Description: Shielded Connection type head A: Female connector, M12, 8-pin, straight, A-coded Connection systems: Screw-type terminals Permitted cross-section: 0.25 mm² ... 0.5 mm² Application: Hygienic and washdown zones | YF12ES8-0050S5586A | 2097334 |
|  | <ul style="list-style-type: none"> Description: Incremental, shielded Connection type head A: Female connector, M12, 8-pin, straight Connection type head B: Male connector, D-Sub, 9-pin, straight Signal type: Incremental Cable: 0.5 m, 8-wire Note: Programming adapter cable for programming tool PGT-10-Pro and PGT-08-S | DSL-2D08-G0M5AC3 | 2046579 |

SICK AT A GLANCE

SICK is one of the leading manufacturers of intelligent sensors and sensor solutions for industrial applications. A unique range of products and services creates the perfect basis for controlling processes securely and efficiently, protecting individuals from accidents and preventing damage to the environment.

We have extensive experience in a wide range of industries and understand their processes and requirements. With intelligent sensors, we can deliver exactly what our customers need. In application centers in Europe, Asia and North America, system solutions are tested and optimized in accordance with customer specifications. All this makes us a reliable supplier and development partner.

Comprehensive services complete our offering: SICK LifeTime Services provide support throughout the machine life cycle and ensure safety and productivity.

For us, that is “Sensor Intelligence.”

WORLDWIDE PRESENCE:

Contacts and other locations –www.sick.com