

SICK.COM



DATA SHEET

DBS60E-TDAK01024

DBS60
Incremental encoders

SICK Sensor Intelligence

INCREMENTAL ENCODERS

DBS60E-TDAK01024

ORDERING INFORMATION

Type	part no.
DBS60E-TDAK01024	1088139

Further device versions and accessories at www.sick.com/DBS60



Illustration may differ



DETAILED TECHNICAL DATA

SAFETY-RELATED PARAMETERS

MTTF _D (mean time to dangerous failure)	500 years (EN ISO 13849-1) ¹⁾
--	--

¹⁾ This product is a standard product and does not constitute a safety component as defined in the Machinery Directive. Calculation based on nominal load of components, average ambient temperature 40°C, frequency of use 8760 h/a. All electronic failures are considered hazardous. For more information, see document no. 8015532.

PERFORMANCE

Pulses per revolution	1,024
Measuring step	≤ 90°, electric/pulses per revolution
Measuring step deviation	± 18° / pulses per revolution
Error limits	Measuring step deviation x 3
Duty cycle	≤ 0.5 ± 5 %

INTERFACES

Communication interface	Incremental
Communication Interface detail	TTL / RS-422
Number of signal channels	6-channel
Initialization time	< 5 ms ¹⁾
Output frequency	+ 300 kHz ²⁾
Load current	≤ 30 mA, per channel

¹⁾ Valid signals can be read once this time has elapsed.

²⁾ Up to 450 kHz on request.

Operating current	≤ 50 mA (without load)
-------------------	------------------------

¹⁾ Valid signals can be read once this time has elapsed.

²⁾ Up to 450 kHz on request.

ELECTRONICS

Connection type	Cable, 8-wire, universal, 1.5 m ¹⁾
Supply voltage	4.5 ... 5.5 V
Reference signal, number	1
Reference signal, position	90°, electric, logically gated with A and B
Reverse polarity protection	✓
Short-circuit protection of the outputs	✓ ²⁾

¹⁾ The universal cable connection is positioned so that it is possible to lay it without bends in a radial or axial direction.

²⁾ Short-circuit opposite to another channel or GND permissible for max. 60 s. No protection signal against U_g .

MECHANICS

Mechanical design	Through hollow shaft
Shaft diameter	10 mm Front clamp
Flange type / stator coupling	2-sided stator coupling, slot, screw hole circle 63–83 mm
Weight	+ 0.25 kg ¹⁾
Shaft material	Stainless steel
Flange material	Aluminum
Housing material	Aluminum
Material, cable	PVC
Start up torque	+ 0.5 Ncm (+20 °C)
Operating torque	0.4 Ncm (+20 °C)
Permissible movement static	± 0.3 mm (radial) ± 0.5 mm (axial) ²⁾
Permissible movement dynamic	± 0.1 mm (radial) ± 0.2 mm (axial) ²⁾
Operating speed	6,000 min ⁻¹ ³⁾
Maximum operating speed	9,000 min ⁻¹ ⁴⁾
Moment of inertia of the rotor	50 gcm ²
Bearing lifetime	3.6 x 10 ⁹ revolutions
Angular acceleration	≤ 500,000 rad/s ²

¹⁾ Based on encoder with male connector or cable with male connector.

²⁾ Not applicable for stator coupling type C and K.

³⁾ Allow for self-heating of 2.6 K per 1,000 rpm when designing the operating temperature range.

⁴⁾ Maximum speed which does not cause mechanical damage to the encoder. Impact on the service life and signal quality is possible. Please note the maximum output frequency.

AMBIENT DATA

EMC	According to EN 61000-6-2 and EN 61000-6-3
Enclosure rating	IP65, housing side (IEC 60529) IP65, shaft side (IEC 60529)
Permissible relative humidity	90 % (Condensation not permitted)
Operating temperature range	-20 °C ... +85 °C ¹⁾

¹⁾ These values relate to all mechanical versions including recommended accessories unless otherwise noted.

Storage temperature range	-40 °C ... +100 °C, without package
Resistance to shocks	250 g, 3 ms (EN 60068-2-27)
Resistance to vibration	30 g, 10 Hz ... 2,000 Hz (EN 60068-2-6)

¹ These values relate to all mechanical versions including recommended accessories unless otherwise noted.

CERTIFICATES

EU declaration of conformity	✓
UK declaration of conformity	✓
ACMA declaration of conformity	✓
China RoHS	✓
cULus certificate	✓
Information according to Art. 3 of Data Act (Regulation EU 2023/2854)	✓

DIMENSIONAL DRAWING

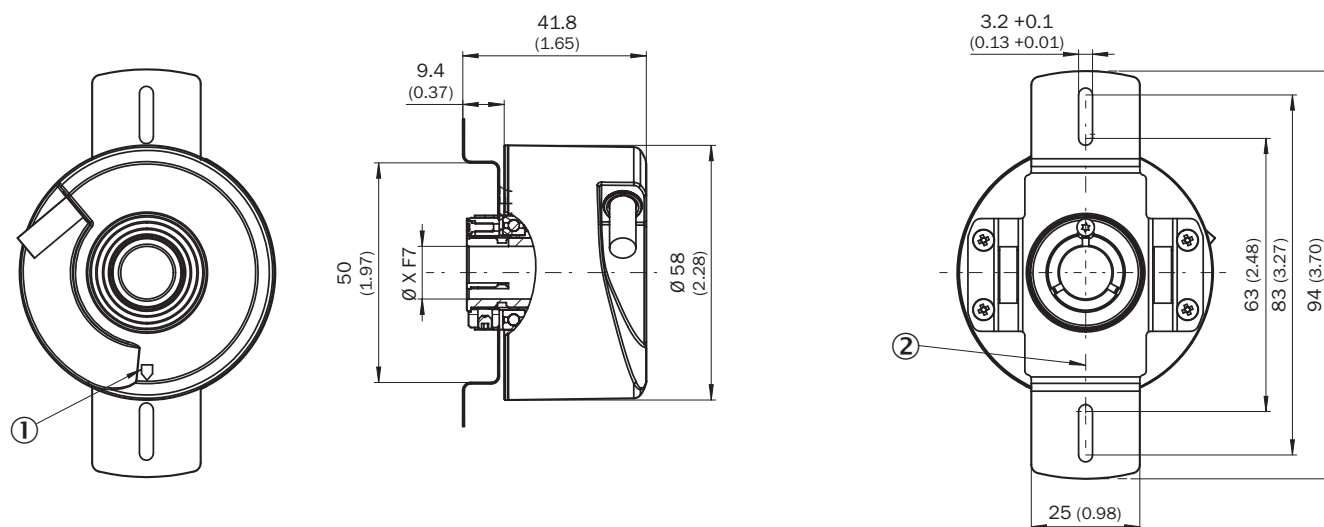

Dimensions in mm (inch)

XF7 values see shaft diameter table for through hollow shaft, clamping at the front

- ① Zero pulse mark on housing
- ② zero pulse mark on flange under stator coupling

Type	Through hollow shaft with front clamping	Shaft diameter XF7
DBS60x-TAxxxxxxx		6 mm
DBS60x-T1xxxxxxx		
DBS60x-TBxxxxxxx		8 mm
DBS60x-T2xxxxxxx		
DBS60x-TCxxxxxxx		3/8"
DBS60x-T3xxxxxxx		
DBS60x-TDxxxxxxx		10 mm
DBS60x-T4xxxxxxx		
DBS60x-TExxxxxxx		12 mm
DBS60x-T5xxxxxxx		
DBS60x-TFxxxxxxx		1/2"
DBS60x-T6xxxxxxx		
DBS60x-TGxxxxxxx		14 mm
DBS60x-T7xxxxxxx		
DBS60x-THxxxxxxx		15 mm
DBS60x-T8xxxxxxx		

Type	Through hollow shaft with front clamping	Shaft diameter XF7
	DBS60x-TJxxxxxxxx	5/8"
	-	

ATTACHMENT SPECIFICATIONS THROUGH HOLLOW SHAFT WITH FRONT CLAMPING

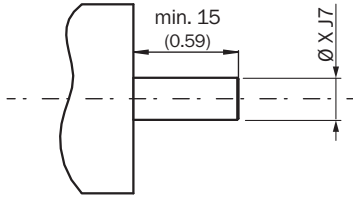

customer side

Type	Through hollow shaft with front clamping	Shaft diameter xj7
	DBS60x-TAxxxxxxxx DBS60x-T1xxxxxxxx	6 mm
	DBS60x-TBxxxxxxxx DBS60x-T2xxxxxxxx	8 mm
	DBS60x-TCxxxxxxxx DBS60x-T3xxxxxxxx	3/8"
	DBS60x-TDxxxxxxxx DBS60x-T4xxxxxxxx	10 mm
	DBS60x-TExxxxxxxx DBS60x-T5xxxxxxxx	12 mm
	DBS60x-TFxxxxxxxx DBS60x-T6xxxxxxxx	1/2"
	DBS60x-TGxxxxxxxx DBS60x-T7xxxxxxxx	14 mm
	DBS60x-THxxxxxxxx DBS60x-T8xxxxxxxx	15 mm
	DBS60x-TJxxxxxxxx	5/8"
	-	

PIN ASSIGNMENT



Wire colors (cable connection)	Male connector M12, 8-pin	Male connector M23, 12-pin	TTL/HTL 6-channel signal	Explanation
Brown	1	6	A-	Signal wire
White	2	5	A	Signal wire
Black	3	1	B-	Signal wire
Pink	4	8	B	Signal wire
Yellow	5	4	Z-	Signal wire
Purple	6	3	Z	Signal wire
Blue	7	10	GND	Ground connection
Red	8	12	+U _s	Supply voltage
-	-	9	Not assigned	Not assigned
-	-	2	Not assigned	Not assigned
-	-	11	Not assigned	Not assigned

Wire colors (cable connection)	Male connector M12, 8-pin	Male connector M23, 12-pin	TTL/HTL 6-channel signal	Explanation
-	-	7	Not assigned	Not assigned
Screen	Screen	Screen	Screen	Screen connected to encoder housing

DIAGRAMS

Pulses per revolution

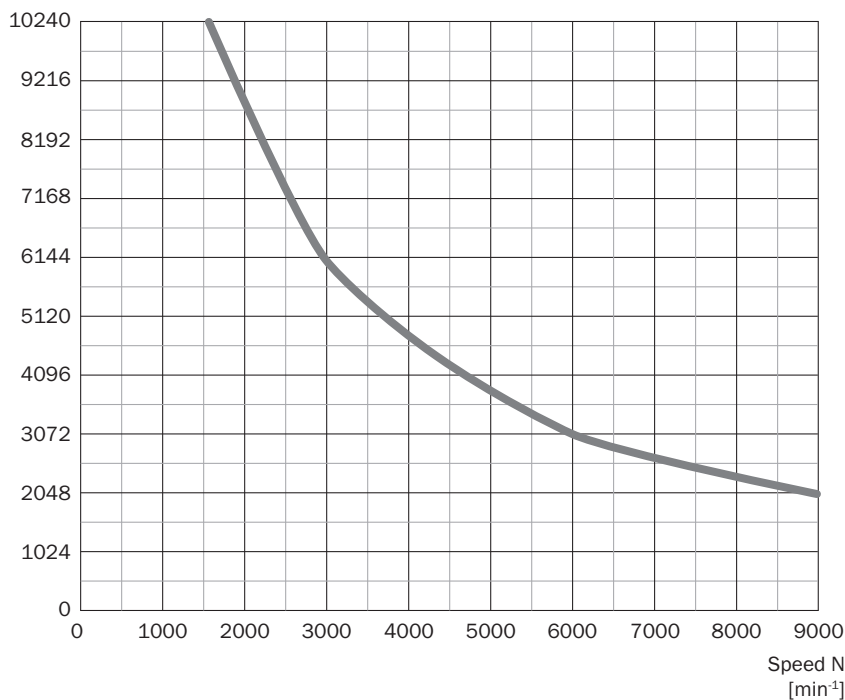

DIAGRAMS SIGNAL OUTPUTS FOR ELECTRICAL INTERFACES TTL AND HTL



Cw with view on the encoder shaft in direction "A", compare dimensional drawing.

Supply voltage	Output
4,5 V ... 5,5 V	TTL

Supply voltage	Output
10 V ... 30 V	TTL
10 V ... 27 V	HTL
4,5 V ... 30 V	TTL/HTL universal
4,5 V ... 30 V	TTL

Further information as well as suitable accessories, example applications and downloads such as CAD dimensional models, operating instructions and software can be found at www.sick.com/1088139



SICK AG
WALDKIRCH
GERMANY
SICK.COM

SICK AT A GLANCE

SICK is a leading global technology company for intelligent sensors and integrated solutions in industrial automation. Our technologies set benchmarks, making your industrial processes more efficient, safer and more sustainable – both in logistics and manufacturing operations.

SICK combines sensor intelligence with industry expertise and certified consulting services. We provide the ideal foundation for scalable as well as tailor-made automation solutions and create added value along the entire value chain. Our close partnerships with our customers are more than just a promise: Together, we optimize productivity, improve quality, protect health and safety, and help build a sustainable future. All with empathy and trust.

Since 1946, we have been developing innovative technologies with passion and a pioneering spirit. With a global network in around 40 countries, SICK has a global presence and is always close by. The company's headquarters are located in Waldkirch near Freiburg, Germany. Our customers benefit from our understanding of both local and global requirements, which enables us to deliver tailor-made solutions

SICK
Sensor Intelligence