



# HL18-L5G3AE

H18 Sure Sense

PHOTOELECTRIC SENSORS

**SICK**  
Sensor Intelligence.



Illustration may differ



### Ordering information

Type	part no.
HL18-L5G3AE	1087806

Other models and accessories → [www.sick.com/H18\\_Sure\\_Sense](http://www.sick.com/H18_Sure_Sense)

### Detailed technical data

#### Features

<b>Functional principle</b>	Photoelectric retro-reflective sensor
<b>Functional principle detail</b>	With minimum distance to reflector (dual lens system)
<b>Dimensions (W x H x D)</b>	16.2 mm x 45.5 mm x 34.4 mm
<b>Housing design (light emission)</b>	Hybrid
<b>Thread diameter (housing)</b>	M18
<b>Mounting system type</b>	M18, head/side (24.1 ... 25.4 mm)
<b>Housing color</b>	Blue
<b>Sensing range max.</b>	0.03 m ... 6.5 m <sup>1)</sup>
<b>Sensing range</b>	0.03 m ... 5 m <sup>1)</sup>
<b>Type of light</b>	Visible red light
<b>Light source</b>	PinPoint LED <sup>2)</sup>
<b>Light spot size (distance)</b>	130 mm x 260 mm (6.5 m)
<b>Wave length</b>	631 nm
<b>Adjustment</b>	
	Potentiometer, right
	Potentiometer, left
	Light/dark switching
	None
<b>Special features</b>	-

<sup>1)</sup> Reflector PL80A.

<sup>2)</sup> Average service life: 100,000 h at T<sub>U</sub> = +25 °C.

## Mechanics/electronics

<b>Supply voltage</b>	21.6 V DC ... 250 V DC, 96 V AC ... 250 V AC <sup>1)</sup>
<b>Current consumption</b>	≤ 10 mA <sup>2)</sup>
<b>Switching output</b>	MOSFET
<b>Switching mode</b>	Light switching
<b>Switching output detail</b>	
Switching output Q1	MOSFET, Light switching
<b>Output current I<sub>max</sub></b>	≤ 100 mA
<b>Response time</b>	≤ 0.5 ms <sup>3)</sup>
<b>Switching frequency</b>	1,000 Hz <sup>4)</sup>
<b>Connection type</b>	Cable with male connector, micro (1/2"-20), 4-pin, 2,000 mm
<b>Cable material</b>	Plastic, PVC
<b>Conductor cross section</b>	0.2 mm <sup>2</sup>
<b>Circuit protection</b>	A <sup>5)</sup> B <sup>6)</sup> D <sup>7)</sup>
<b>Protection class</b>	II <sup>8)</sup>
<b>Weight</b>	18 g
<b>Polarizing filter</b>	✓
<b>Housing material</b>	Plastic, VISTAL®
<b>Optics material</b>	Plastic, PMMA
<b>Enclosure rating</b>	IP67 IP69K
<b>Items supplied</b>	Fastening nut (1x), M18, plastic, black, flat
<b>Electromagnetic compatibility (EMC)</b>	EN 60947-5-2 (The sensor complies with the Radio Safety Requirements (EMC) for the industrial sector (Radio Safety Class A). It may cause radio interference if used in a residential area.)
<b>Ambient operating temperature</b>	-40 °C ... +70 °C
<b>Ambient temperature, storage</b>	-40 °C ... +75 °C
<b>UL File No.</b>	E189383

<sup>1)</sup> From T<sub>u</sub> 60 °C, max. supply voltage = 120 V.

<sup>2)</sup> Without load. The output load and sensor must use the same power source.

<sup>3)</sup> Signal transit time with resistive load.

<sup>4)</sup> With light/dark ratio 1:1.

<sup>5)</sup> A = V<sub>S</sub> connections reverse-polarity protected.

<sup>6)</sup> B = inputs and output reverse-polarity protected.

<sup>7)</sup> D = outputs overcurrent and short-circuit protected.

<sup>8)</sup> Reference voltage: 250 V AC, overvoltage category 2.

## Safety-related parameters

<b>MTTF<sub>D</sub></b>	499.9 years
<b>DC<sub>avg</sub></b>	0 %

## Connection type/pinouts

<b>Connection type</b>	
	Cable with male connector, micro (1/2"-20), 4-pin, 2,000 mm

<b>Connection type Detail</b>	
Cable material	Plastic
Conductor cross section	0.2 mm <sup>2</sup>
<b>Pinouts</b>	
RD/BK 1	L1
WH/RD 2	N
RD 3	Q
GN/YE 4	Not connected

### Certificates

<b>EU declaration of conformity</b>	✓
<b>UK declaration of conformity</b>	✓
<b>ACMA declaration of conformity</b>	✓
<b>Moroccan declaration of conformity</b>	✓
<b>China RoHS</b>	✓

### Classifications

<b>ECLASS 5.0</b>	27270902
<b>ECLASS 5.1.4</b>	27270902
<b>ECLASS 6.0</b>	27270902
<b>ECLASS 6.2</b>	27270902
<b>ECLASS 7.0</b>	27270902
<b>ECLASS 8.0</b>	27270902
<b>ECLASS 8.1</b>	27270902
<b>ECLASS 9.0</b>	27270902
<b>ECLASS 10.0</b>	27270902
<b>ECLASS 11.0</b>	27270902
<b>ECLASS 12.0</b>	27270902
<b>ETIM 5.0</b>	EC002717
<b>ETIM 6.0</b>	EC002717
<b>ETIM 7.0</b>	EC002717
<b>ETIM 8.0</b>	EC002717
<b>UNSPSC 16.0901</b>	39121528

Dimensional drawing

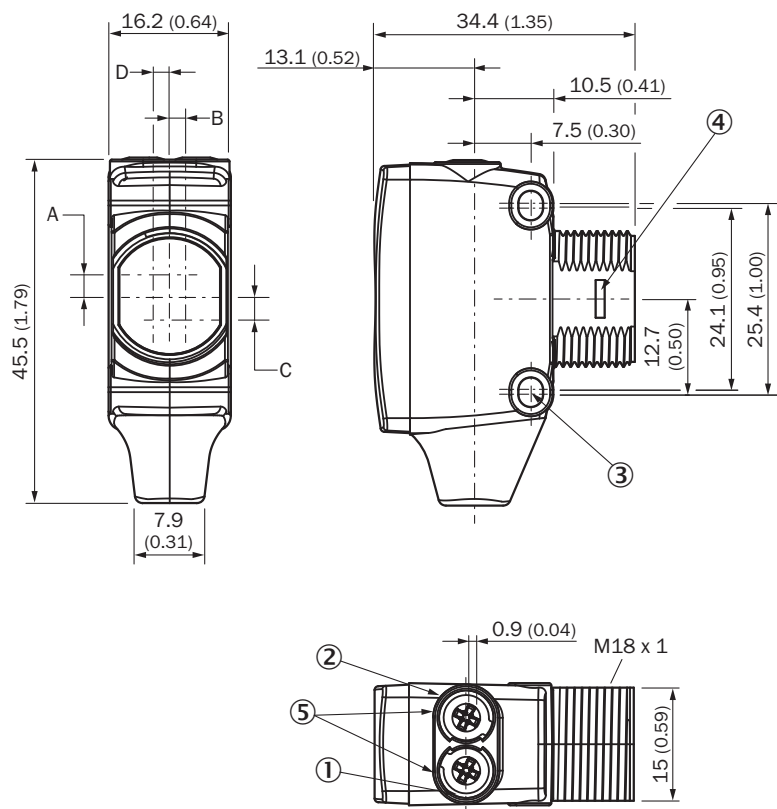

Dimensions in mm (inch)

- ① LED indicator yellow: Status of received light beam
- ② LED indicator green: power on
- ③ M3 mounting hole
- ④ Snap Connection for flush ring (sold separately)
- ⑤ Potentiometer (if selected) or LED Indicators

Dimensions in mm (inch)	Receiver		Sender	
	A	B	C	D
HTB18 / HTF18	- 1.1 (0.04)	1.1 (0.04)	4.7 (0.19)	0.6 (0.02)
HTE18 / HL18 / HSE18	2.5 (0.1)	0.0 (0.0)	4.0 (0.16)	0.0 (0.0)

Pinouts, see table Technical data: Connection type/pinouts

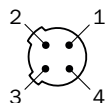

## Characteristic curve

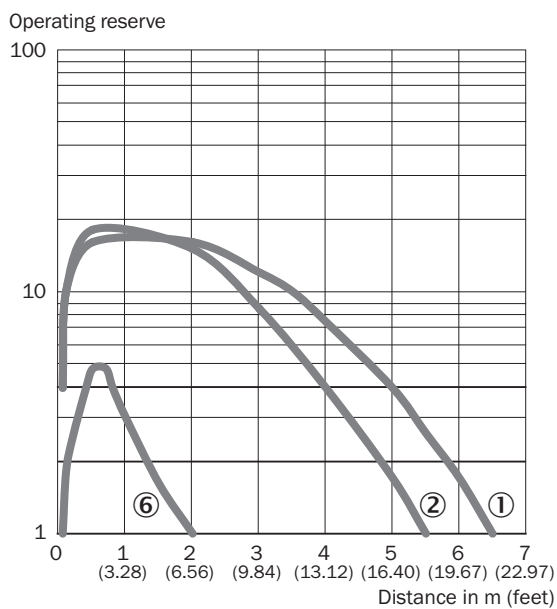

- ① Reflector PL80A
- ② Reflector PL40A
- ③ Reflective tape IREF6000 (REF-IRF-56)

## Light spot size

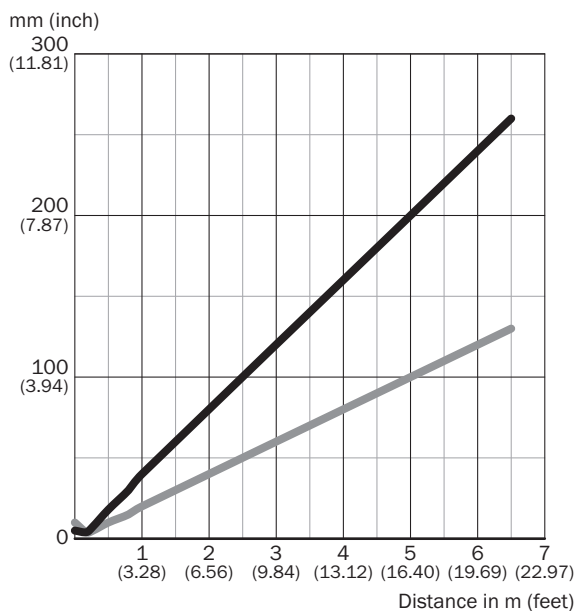

### Dimensions in mm (inch)

Sensing range	Horizontal	Vertical
<b>0.5 m</b> <b>(1.64 feet)</b>	18 (0.71)	10 (0.39)
<b>1 m</b> <b>(3.28 feet)</b>	40 (1.57)	20 (0.79)
<b>5 m</b> <b>(16.40 feet)</b>	200 (7.87)	100 (3.94)
<b>6.5 m</b> <b>(21.33 feet)</b>	260 (10.24)	130 (5.12)

- Horizontal
- Vertical

## Sensing range diagram

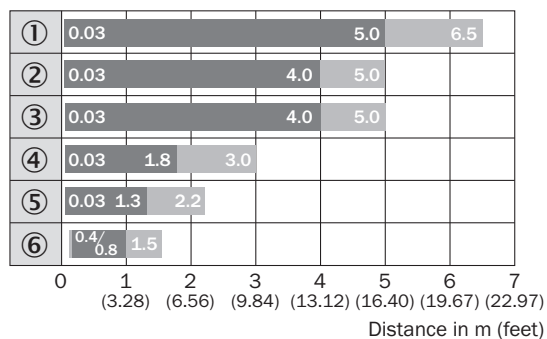

■ Sensing range      ■ Sensing range max.



- ① Reflector PL80A
- ② Reflector PL40A
- ③ Reflector P250
- ④ Reflector PL30A, PL31A
- ⑤ Reflector PL20A
- ⑥ Reflective tape IREF6000 (REF-IRF-56)

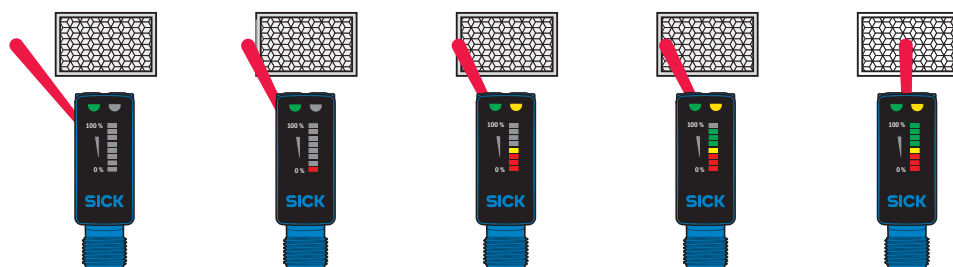

## Functions



## Recommended accessories

Other models and accessories → [www.sick.com/H18\\_Sure\\_Sense](http://www.sick.com/H18_Sure_Sense)

	Brief description	Type	part no.
Mounting systems			
	<ul style="list-style-type: none"> <li>• <b>Description:</b> Mounting bracket for M18 sensors</li> <li>• <b>Material:</b> Steel</li> <li>• <b>Details:</b> Steel, zinc coated</li> <li>• <b>Items supplied:</b> Without mounting hardware</li> <li>• <b>Suitable for:</b> GR18, V180-2, V18, W15, Z1, Z2</li> </ul>	BEF-WN-M18	5308446
	<ul style="list-style-type: none"> <li>• <b>Description:</b> Universal mounting bracket for reflectors</li> <li>• <b>Dimensions (W x H x L):</b> 85 mm x 90 mm x 35 mm</li> <li>• <b>Material:</b> Steel</li> <li>• <b>Details:</b> Steel, zinc coated</li> <li>• <b>Suitable for:</b> C110A, P250, PL20, PL30A, PL40A, PL80A</li> </ul>	BEF-WN-REFX	2064574

	Brief description	Type	part no.
reflectors and optics			
	<ul style="list-style-type: none"> <li>• <b>Description:</b> Rectangular, screw connection</li> <li>• <b>Dimensions:</b> 51 mm 61 mm</li> <li>• <b>Ambient operating temperature:</b> -30 °C ... +65 °C</li> </ul>	P250	5304812
connectors and cables			
	<ul style="list-style-type: none"> <li>• <b>Description:</b> Sensor/actuator cable</li> <li>• <b>Connection type head A:</b> Female connector, 1/2"-20, 4-pin, straight</li> <li>• <b>Connection type head B:</b> Flying leads</li> <li>• <b>Signal type:</b> Sensor/actuator cable</li> <li>• <b>Cable:</b> 2 m, 4-wire, PVC</li> <li>• <b>Connection systems:</b> Flying leads</li> </ul>	KA24-SIF22	7023591

## SICK AT A GLANCE

SICK is one of the leading manufacturers of intelligent sensors and sensor solutions for industrial applications. A unique range of products and services creates the perfect basis for controlling processes securely and efficiently, protecting individuals from accidents and preventing damage to the environment.

We have extensive experience in a wide range of industries and understand their processes and requirements. With intelligent sensors, we can deliver exactly what our customers need. In application centers in Europe, Asia and North America, system solutions are tested and optimized in accordance with customer specifications. All this makes us a reliable supplier and development partner.

Comprehensive services complete our offering: SICK LifeTime Services provide support throughout the machine life cycle and ensure safety and productivity.

For us, that is “Sensor Intelligence.”

## WORLDWIDE PRESENCE:

Contacts and other locations –[www.sick.com](http://www.sick.com)