



HL18G-P3A3AL

H18 Sure Sense

PHOTOELECTRIC SENSORS

SICK
Sensor Intelligence.



Illustration may differ



Ordering information

Type	part no.
HL18G-P3A3AL	1083544

Other models and accessories → www.sick.com/H18_Sure_Sense

Detailed technical data

Features

Functional principle	Photoelectric retro-reflective sensor
Functional principle detail	With minimum distance to reflector (dual lens system)
Dimensions (W x H x D)	16.2 mm x 44.9 mm x 31.8 mm
Housing design (light emission)	Hybrid
Thread diameter (housing)	M18
Mounting system type	M18, head/side (24.1 ... 25.4 mm)
Housing color	Blue
Sensing range max.	0.1 m ... 3 m ¹⁾
Sensing range	0.1 m ... 2.5 m ¹⁾
Type of light	Visible red light
Light source	PinPoint LED ²⁾
Light spot size (distance)	60 mm x 120 mm (3 m)
Wave length	631 nm
Adjustment	
	Potentiometer, right Teach-in
	Potentiometer, left None
AutoAdapt	✓
Special applications	Detecting transparent objects
Special features	AutoAdapt

¹⁾ Reflector PL80A.

²⁾ Average service life: 100,000 h at T_J = +25 °C.

Mechanics/electronics

Supply voltage	10 V DC ... 30 V DC
Ripple	$< 5 V_{pp}^{1)}$
Current consumption	$\leq 20 \text{ mA}^{2)}$
Switching output	PNP
Output function	Complementary
Switching mode	Light/dark switching
Switching output detail	
Switching output Q1	PNP, Light switching
Switching output Q2	PNP, Dark switching
Output current I_{max}	$\leq 100 \text{ mA}$
Response time	$\leq 0.5 \text{ ms}^{3)}$
Switching frequency	$1,000 \text{ Hz}^{4)}$
Connection type	Male connector M8, 4-pin
Cable material	Plastic, PVC
Circuit protection	A ⁵⁾ B ⁶⁾ D ⁷⁾
Protection class	III
Weight	18 g
Polarizing filter	✓
Housing material	Plastic, VISTAL®
Optics material	Plastic, PMMA
Enclosure rating	IP67 IP69K
Items supplied	Fastening nut (1x), M18, plastic, black, flat
Electromagnetic compatibility (EMC)	EN 60947-5-2 (The sensor complies with the Radio Safety Requirements (EMC) for the industrial sector (Radio Safety Class A). It may cause radio interference if used in a residential area.)
Ambient operating temperature	$-40 \text{ °C} \dots +70 \text{ °C}$
Ambient temperature, storage	$-40 \text{ °C} \dots +75 \text{ °C}$
UL File No.	E189383

¹⁾ May not fall below or exceed U_V tolerances.

²⁾ Without signal strength light bar and load.

³⁾ Signal transit time with resistive load.

⁴⁾ With light/dark ratio 1:1.

⁵⁾ A = V_S connections reverse-polarity protected.

⁶⁾ B = inputs and output reverse-polarity protected.

⁷⁾ D = outputs overcurrent and short-circuit protected.

Safety-related parameters

MTTF_D	936.1 years
DC_{avg}	0 %

Connection type/pinouts

Connection type	
------------------------	--

		Male connector M8, 4-pin
Connection type Detail		
	Cable material	Plastic
Pinouts	BN 1	+ (L+)
	WH 2	Q ₂
	BU 3	- (M)
	BK 4	Q ₁

Certificates

EU declaration of conformity	✓
UK declaration of conformity	✓
ACMA declaration of conformity	✓
Moroccan declaration of conformity	✓
China RoHS	✓
cULus certificate	✓

Classifications

ECLASS 5.0	27270902
ECLASS 5.1.4	27270902
ECLASS 6.0	27270902
ECLASS 6.2	27270902
ECLASS 7.0	27270902
ECLASS 8.0	27270902
ECLASS 8.1	27270902
ECLASS 9.0	27270902
ECLASS 10.0	27270902
ECLASS 11.0	27270902
ECLASS 12.0	27270902
ETIM 5.0	EC002717
ETIM 6.0	EC002717
ETIM 7.0	EC002717
ETIM 8.0	EC002717
UNSPSC 16.0901	39121528

Dimensional drawing

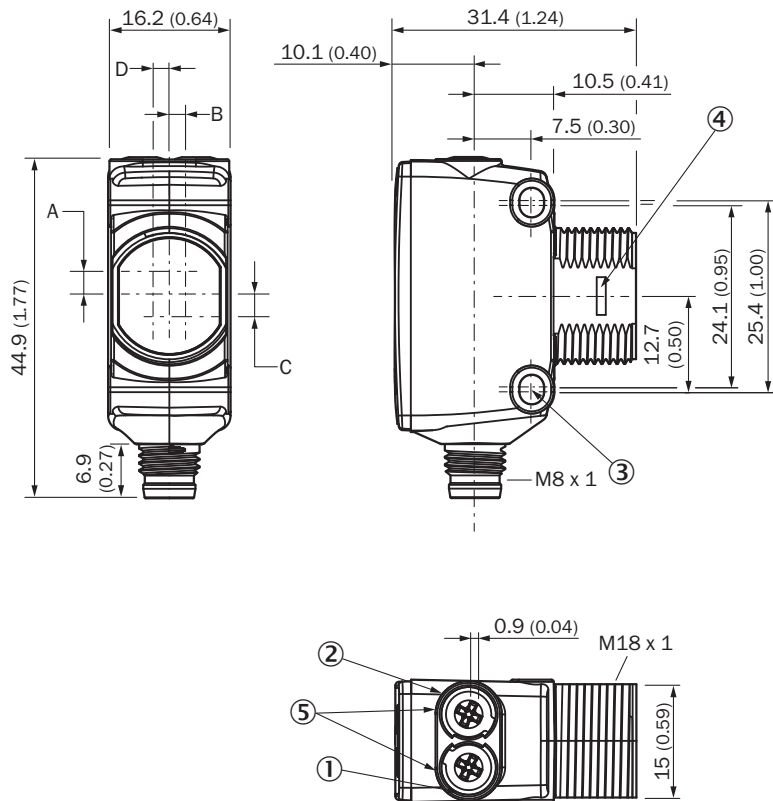

Dimensions in mm (inch)

- ① LED indicator yellow: Status of received light beam
- ② LED indicator green: power on
- ③ M3 mounting hole
- ④ Snap Connection for flush ring (sold seperatly)
- ⑤ Potentiometer (if selected) or LED Indicators

Dimensions in mm (inch)	Receiver		Sender	
	A	B	C	D
HTB18 / HTF18	- 1.1 (0.04)	1.1 (0.04)	4.7 (0.19)	0.6 (0.02)
HTE18 / HL18 / HSE18	2.5 (0.1)	0.0 (0.0)	4.0 (0.16)	0.0 (0.0)
HTB18L / HTF18L / HL18L / HSE18L	2.5 (0.1)	0.0 (0.0)	3.5 (0.14)	0.0 (0.0)

Pinouts, see table Technical data: Connection type/pinouts

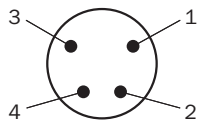

Male connector, M8, 4-pin, uncoded

Characteristic curve

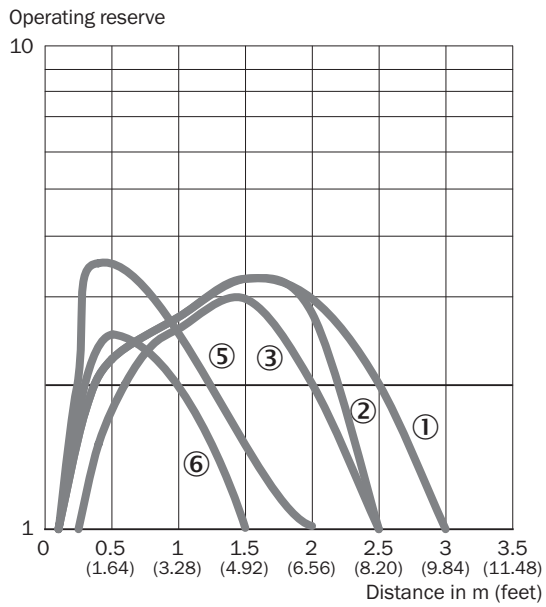

- ① Reflector PL80A
- ② Reflector PL40A
- ③ Reflector P250F
- ⑤ Reflective tape REF-AC1000
- ⑥ Reflector PL41F

Light spot size

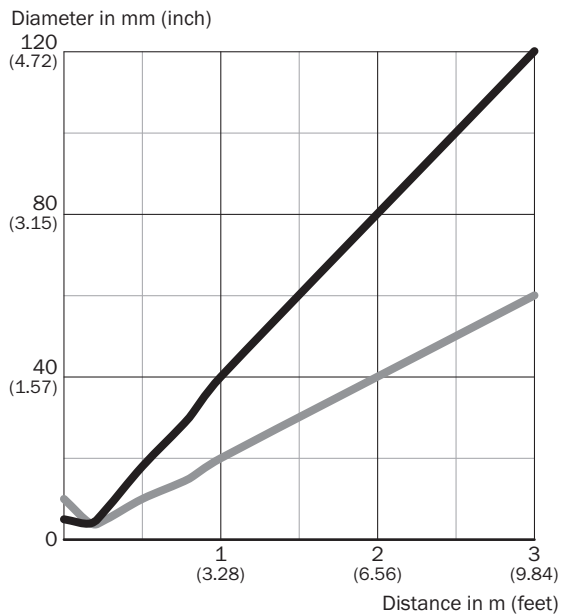

Dimensions in mm (inch)

Sensing range	Vertical	Horizontal
0.5 m (1.64 feet)	18 (0.71)	10 (0.39)
0.8 m (2.62 feet)	30 (1.18)	15 (0.59)
1 m (3.28 feet)	40 (1.57)	20 (0.79)
3 m (9.84 feet)	120 (4.72)	60 (2.36)

- Vertical
- Horizontal

Sensing range diagram

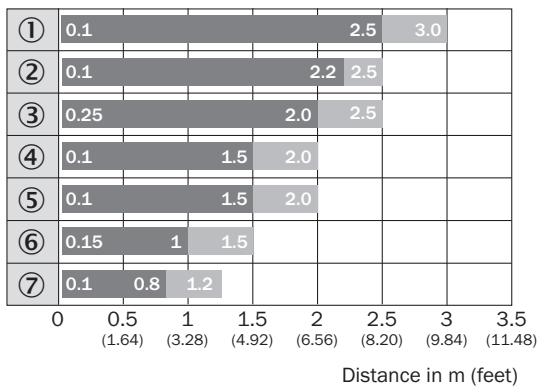

■ Sensing range ■ Sensing range max.



- ① Reflector PL80A
- ② Reflector PL40A
- ③ Reflector P250F
- ④ Reflector PL30A, PL31A
- ⑤ Reflective tape REF-AC1000
- ⑥ Reflector PL41F
- ⑦ Reflector PL20A

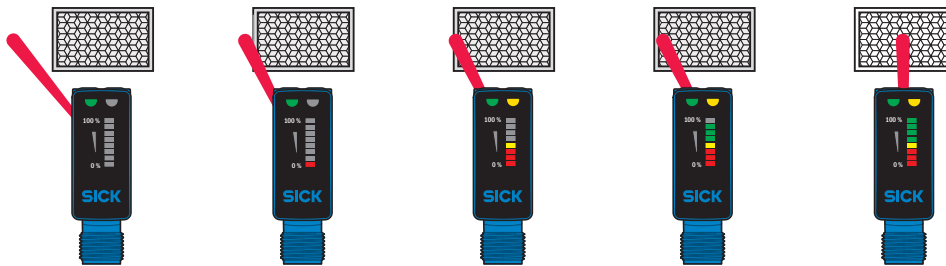



Functions



Recommended accessories

Other models and accessories → www.sick.com/H18_Sure_Sense

	Brief description	Type	part no.
Mounting systems			
	<ul style="list-style-type: none"> • Description: Mounting bracket for M18 sensors • Material: Steel • Details: Steel, zinc coated • Items supplied: Without mounting hardware • Suitable for: GR18, V180-2, V18, W15, Z1, Z2 	BEF-WN-M18	5308446
	<ul style="list-style-type: none"> • Description: Plate N11N for universal clamp bracket • Material: Stainless steel • Details: Stainless steel 1.4571 (sheet), Stainless steel 1.4408 (clamp) • Items supplied: Universal clamp (5322627), mounting hardware • Usable for: DeltaPac, Glare, WTD20E 	BEF-KHS-N11N	2071081

	Brief description	Type	part no.
reflectors and optics			
	<ul style="list-style-type: none"> Description: Reflector with microprismatic reflex tape REF-AC1000, suitable for laser sensors, see alignment note Dimensions: 29 mm 45 mm Ambient operating temperature: -30 °C ... +60 °C 	P41F	5315128
connectors and cables			
	<ul style="list-style-type: none"> Description: Sensor/actuator cable, unshielded Connection type head A: Female connector, M8, 4-pin, straight, A-coded Connection type head B: Flying leads Signal type: Sensor/actuator cable Cable: 5 m, 4-wire, PVC Application: Uncontaminated zones, Zones with chemicals 	YF8U14-050VA3XLEAX	2095889
	<ul style="list-style-type: none"> Description: Unshielded Connection type head A: Male connector, M8, 4-pin, straight, A-coded Connection systems: Screw-type terminals Permitted cross-section: 0.14 mm² ... 0.5 mm² 	STE-0804-G	6037323
	<ul style="list-style-type: none"> Description: Sensor/actuator cable, unshielded Connection type head A: Female connector, M8, 4-pin, straight, A-coded Connection type head B: Flying leads Signal type: Sensor/actuator cable Cable: 5 m, 4-wire, PUR, halogen-free Application: Drag chain operation, Zones with oils and lubricants, Robot, Drag chain operation 	YF8U14-050UA3XLEAX	2094792

SICK AT A GLANCE

SICK is one of the leading manufacturers of intelligent sensors and sensor solutions for industrial applications. A unique range of products and services creates the perfect basis for controlling processes securely and efficiently, protecting individuals from accidents and preventing damage to the environment.

We have extensive experience in a wide range of industries and understand their processes and requirements. With intelligent sensors, we can deliver exactly what our customers need. In application centers in Europe, Asia and North America, system solutions are tested and optimized in accordance with customer specifications. All this makes us a reliable supplier and development partner.

Comprehensive services complete our offering: SICK LifeTime Services provide support throughout the machine life cycle and ensure safety and productivity.

For us, that is “Sensor Intelligence.”

WORLDWIDE PRESENCE:

Contacts and other locations –www.sick.com