



CFP0500-XPANNBX

CFP Cubic

LEVEL SENSORS

SICK
Sensor Intelligence.



Illustration may differ



Ordering information

Type	part no.
CFP0500-XPANNBX	1082627

Other models and accessories → www.sick.com/CFP_Cubic

Detailed technical data

Features

Medium	Fluids
Measurement	Switch, Continuous
Probe length	500 mm
Process pressure	-0.5 bar ... 3 bar
Process temperature	-20 °C ... +80 °C
UL approval	✓
RoHS certificate	✓
IO-Link	✓

Performance

Accuracy of sensor element	± 15 mm, with water or oil under reference conditions
Reproducibility	< 5 mm
Resolution	< 2 mm
Response time	< 300 ms
Dielectricity constant	≥ 2
Conductivity	No limitation
Deactivated area at end of probe	7 mm ... 15 mm, Depending on probe length
MTTF	171 years
Display	✓

Electronics

Communication interface	IO-Link
Supply voltage	10 V DC ... 30 V DC ¹⁾
Power consumption	≤ 100 mA at 24 V DC without output load
Initialization time	≤ 4 s
Protection class	III
Connection type	Round connector M12 x 1, 5-pin
Output signal	2 x PNP/NPN/push-pull transistor outputs switchable and 1 x analog output 4 mA ... 20 mA / 0 V ... 10 V automatically switchable depending on output load or output voltage depending on the load
Output load	4 mA ... 20 mA < 500 Ohm at U _v > 15 V, 4 mA ... 20 mA < 350 Ohm at U _v > 12 V, 0 V ... 10 V > 750 Ohm at U _v 14 ≥ V
Hysteresis	Min. 3 mm, min. 2 °C, free adjustable
Output current	< 100 mA
Inductive load	< 1 H
Capacitive load	100 nF
Enclosure rating	IP67
Temperature drift	< 0.1 mm/K
Lower signal level	3.8 mA ... 4 mA
Upper signal level	20 mA ... 20.5 mA
Resolution of analog output	12 bit

¹⁾ All connections are polarity protected. All outputs are overload and short-circuit protected.

Mechanics

Wetted parts	Outer tube: polypropylene (PP-H) G ¾" and ¾" NPT: PPSU Easy-clamp bracket: PP
Process connection	G ¾ A
Housing material	PBT / PC
Max. probe load	≤ 4 Nm
Probe diameter	16 mm

Ambient data

Ambient operating temperature	-20 °C ... +60 °C
Ambient temperature, storage	-40 °C ... +80 °C

Certificates

EU declaration of conformity	✓
UK declaration of conformity	✓
ACMA declaration of conformity	✓
Moroccan declaration of conformity	✓
China RoHS	✓
cULus certificate	✓
IO-Link certificate	✓

Classifications

ECLASS 5.0	27200503
ECLASS 5.1.4	27200503
ECLASS 6.0	27200503
ECLASS 6.2	27200503
ECLASS 7.0	27200503
ECLASS 8.0	27200503
ECLASS 8.1	27200503
ECLASS 9.0	27200503
ECLASS 10.0	27200503
ECLASS 11.0	27200503
ECLASS 12.0	27200503
ETIM 5.0	EC001447
ETIM 6.0	EC001447
ETIM 7.0	EC001447
ETIM 8.0	EC001447
UNSPSC 16.0901	41113710

Dimensional drawing

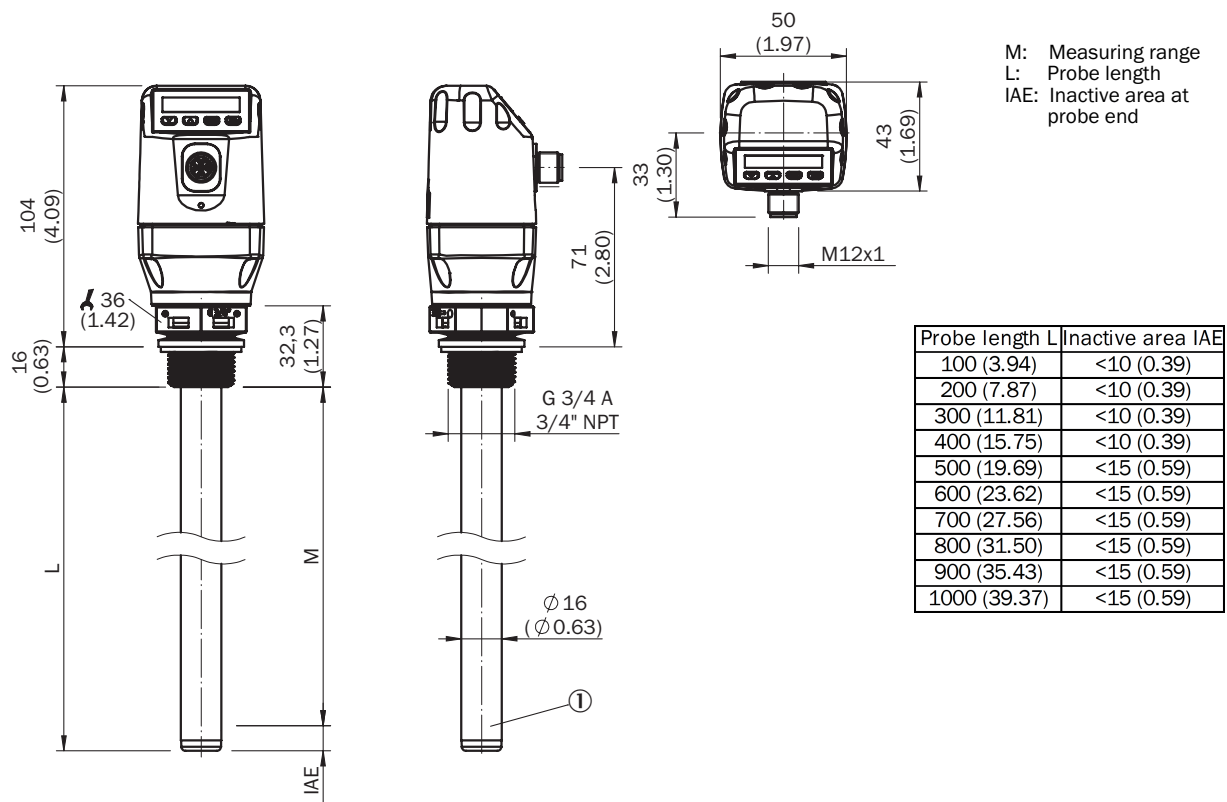

Dimensions in mm (inch)

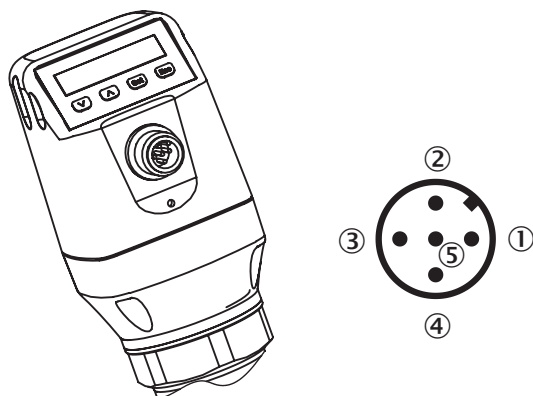

Connection type













- ① L⁺: Supply voltage
- ② Q_A: Analog current-/voltage output
- ③ M: Ground, reference ground for current-/voltage output
- ④ C/Q1: Switching output 2, PNP/NPN/DRV (Push-Pull) / IO-Link
- ⑤ Q₂: Switching output 2, PNP/NPN/DRV (Push-Pull)

Recommended accessories

Other models and accessories → www.sick.com/CFP_Cubic

	Brief description	Type	part no.
network devices			
		IOLA2US-01101 (SiLink2 Master)	1061790
signal transmitters			
	<ul style="list-style-type: none"> • Description: IO-Link signal lamp • Enclosure rating: IP65 	SLT060-0B010J700	6075938

	Brief description	Type	part no.
connectors and cables			
	<ul style="list-style-type: none"> • Connection type head A: Female connector, M12, 5-pin, angled, A-coded • Connection type head B: Flying leads • Signal type: Sensor/actuator cable • Cable: 2 m, 5-wire, PVC • Description: Sensor/actuator cable, unshielded • Application: Zones with chemicals, Uncontaminated zones 	YG2A15-020VB5XLEAX	2096215
	<ul style="list-style-type: none"> • Connection type head A: Female connector, M12, 5-pin, angled, A-coded • Connection type head B: Flying leads • Signal type: Sensor/actuator cable • Cable: 5 m, 5-wire, PVC • Description: Sensor/actuator cable, unshielded • Application: Zones with chemicals, Uncontaminated zones 	YG2A15-050VB5XLEAX	2096216
	<ul style="list-style-type: none"> • Connection type head A: Female connector, M12, 5-pin, angled, A-coded • Connection type head B: Flying leads • Signal type: Sensor/actuator cable • Cable: 10 m, 5-wire, PVC • Description: Sensor/actuator cable, unshielded • Application: Zones with chemicals, Uncontaminated zones 	YG2A15-100VB5XLEAX	2096217
	<ul style="list-style-type: none"> • Connection type head A: Female connector, M12, 5-pin, straight, A-coded • Connection type head B: Flying leads • Signal type: Sensor/actuator cable • Cable: 2 m, 5-wire, PUR, halogen-free • Description: Sensor/actuator cable, unshielded • Application: Uncontaminated zones, Zones with oils and lubricants, Robot, Drag chain operation 	YF2A15-020UB5XLEAX	2095617
	<ul style="list-style-type: none"> • Connection type head A: Female connector, M12, 5-pin, straight, A-coded • Connection type head B: Flying leads • Signal type: Sensor/actuator cable • Cable: 5 m, 5-wire, PUR, halogen-free • Description: Sensor/actuator cable, unshielded • Application: Uncontaminated zones, Zones with oils and lubricants, Robot, Drag chain operation 	YF2A15-050UB5XLEAX	2095618
	<ul style="list-style-type: none"> • Connection type head A: Female connector, M12, 5-pin, straight, A-coded • Connection type head B: Flying leads • Signal type: Sensor/actuator cable • Cable: 10 m, 5-wire, PUR, halogen-free • Description: Sensor/actuator cable, unshielded • Application: Uncontaminated zones, Zones with oils and lubricants, Robot, Drag chain operation 	YF2A15-100UB5XLEAX	2095619
	<ul style="list-style-type: none"> • Connection type head A: Female connector, M12, 5-pin, angled, A-coded • Connection type head B: Flying leads • Signal type: Sensor/actuator cable • Cable: 2 m, 5-wire, PUR, halogen-free • Description: Sensor/actuator cable, unshielded • Application: Uncontaminated zones, Zones with oils and lubricants, Robot, Drag chain operation 	YG2A15-020UB5XLEAX	2095772
	<ul style="list-style-type: none"> • Connection type head A: Female connector, M12, 5-pin, angled, A-coded • Connection type head B: Flying leads • Signal type: Sensor/actuator cable • Cable: 5 m, 5-wire, PUR, halogen-free • Description: Sensor/actuator cable, unshielded • Application: Uncontaminated zones, Zones with oils and lubricants, Robot, Drag chain operation 	YG2A15-050UB5XLEAX	2095773
	<ul style="list-style-type: none"> • Connection type head A: Female connector, M12, 5-pin, angled, A-coded • Connection type head B: Flying leads • Signal type: Sensor/actuator cable • Cable: 10 m, 5-wire, PUR, halogen-free • Description: Sensor/actuator cable, unshielded • Application: Uncontaminated zones, Zones with oils and lubricants, Robot, Drag chain operation 	YG2A15-100UB5XLEAX	2095774
	<ul style="list-style-type: none"> • Connection type head A: Female connector, M12, 5-pin, straight, A-coded • Connection type head B: Flying leads • Signal type: Sensor/actuator cable • Cable: 2 m, 5-wire, PVC • Description: Sensor/actuator cable, unshielded • Application: Zones with chemicals, Uncontaminated zones 	YF2A15-020VB5XLEAX	2096239
	<ul style="list-style-type: none"> • Connection type head A: Female connector, M12, 5-pin, straight, A-coded • Connection type head B: Flying leads • Signal type: Sensor/actuator cable • Cable: 5 m, 5-wire, PVC • Description: Sensor/actuator cable, unshielded 	YF2A15-050VB5XLEAX	2096240

	Brief description	Type	part no.
	<ul style="list-style-type: none"> Application: Zones with chemicals, Untaminated zones Connection type head A: Female connector, M12, 5-pin, straight, A-coded Connection type head B: Flying leads Signal type: Sensor/actuator cable Cable: 10 m, 5-wire, PVC Description: Sensor/actuator cable, unshielded Application: Zones with chemicals, Untaminated zones 	YF2A15-100VB5XLEAX	2096241
	<ul style="list-style-type: none"> Connection type head A: Female connector, M12, 5-pin, angled, A-coded Connection type head B: Flying leads Signal type: Sensor/actuator cable Cable: 0.6 m, 5-wire, PUR, halogen-free Description: Sensor/actuator cable, unshielded Application: Untaminated zones, Zones with oils and lubricants, Robot, Drag chain operation 	YG2A15-C60UB5XLEAX	2145540
	<ul style="list-style-type: none"> Connection type head A: Female connector, M12, 5-pin, angled, A-coded Connection type head B: Flying leads Signal type: Sensor/actuator cable Cable: 3 m, 5-wire, PUR, halogen-free Description: Sensor/actuator cable, unshielded Application: Untaminated zones, Zones with oils and lubricants, Robot, Drag chain operation 	YG2A15-030UB5XLEAX	2145543
	<ul style="list-style-type: none"> Connection type head A: Female connector, M12, 5-pin, angled, A-coded Connection type head B: Flying leads Signal type: Sensor/actuator cable Cable: 1 m, 5-wire, PUR, halogen-free Description: Sensor/actuator cable, unshielded Application: Untaminated zones, Zones with oils and lubricants, Robot, Drag chain operation 	YG2A15-010UB5XLEAX	2145541
	<ul style="list-style-type: none"> Connection type head A: Female connector, M12, 5-pin, angled, A-coded Connection type head B: Flying leads Signal type: Sensor/actuator cable Cable: 0.6 m, 5-wire, PVC Description: Sensor/actuator cable, unshielded Application: Zones with chemicals, Untaminated zones 	YG2A15-C60VB5XLEAX	2145573
	<ul style="list-style-type: none"> Connection type head A: Female connector, M12, 5-pin, angled, A-coded Connection type head B: Flying leads Signal type: Sensor/actuator cable Cable: 1 m, 5-wire, PVC Description: Sensor/actuator cable, unshielded Application: Zones with chemicals, Untaminated zones 	YG2A15-010VB5XLEAX	2145574
	<ul style="list-style-type: none"> Connection type head A: Female connector, M12, 5-pin, angled, A-coded Connection type head B: Flying leads Signal type: Sensor/actuator cable Cable: 3 m, 5-wire, PVC Description: Sensor/actuator cable, unshielded Application: Zones with chemicals, Untaminated zones 	YG2A15-030VB5XLEAX	2145575
	<ul style="list-style-type: none"> Connection type head A: Female connector, M12, 5-pin, straight, A-coded Connection type head B: Flying leads Signal type: Sensor/actuator cable Cable: 0.6 m, 5-wire, PVC Description: Sensor/actuator cable, unshielded Application: Zones with chemicals, Untaminated zones 	YF2A15-C60VB5XLEAX	2145570
	<ul style="list-style-type: none"> Connection type head A: Female connector, M12, 5-pin, straight, A-coded Connection type head B: Flying leads Signal type: Sensor/actuator cable Cable: 3 m, 5-wire, PVC Description: Sensor/actuator cable, unshielded Application: Zones with chemicals, Untaminated zones 	YF2A15-030VB5XLEAX	2145572

SICK AT A GLANCE

SICK is one of the leading manufacturers of intelligent sensors and sensor solutions for industrial applications. A unique range of products and services creates the perfect basis for controlling processes securely and efficiently, protecting individuals from accidents and preventing damage to the environment.

We have extensive experience in a wide range of industries and understand their processes and requirements. With intelligent sensors, we can deliver exactly what our customers need. In application centers in Europe, Asia and North America, system solutions are tested and optimized in accordance with customer specifications. All this makes us a reliable supplier and development partner.

Comprehensive services complete our offering: SICK LifeTime Services provide support throughout the machine life cycle and ensure safety and productivity.

For us, that is “Sensor Intelligence.”

WORLDWIDE PRESENCE:

Contacts and other locations –www.sick.com