



HTB18L-P3A5AB

H18 Sure Sense

PHOTOELECTRIC SENSORS

SICK
Sensor Intelligence.

Special applications	Detecting small objects
Special features	-

1) Object with 90% remission (based on standard white, DIN 5033).

2) Object with 6% remission factor (based on standard black, DIN 5033).

3) Average service life: 50,000 h at $T_{U} = +25\text{ °C}$.

4) CLASS 1 LASER PRODUCT EN60825-1:2014, IEC60825-1:2014, Maximum pulse power < 2,5 mW, Pulse length: 4 μ s, Wavelength: 650 ... 670 nm, Complies with 21 CFR 1040.10 and 1040.11 except for deviations pursuant to Laser Notice No. 50, dated June 24, 2007.

5) Do not intentionally look into the laser beam. Never point the laser beam at people's eyes.

Mechanics/electronics

Supply voltage	10 V DC ... 30 V DC
Ripple	< 5 V _{pp} ¹⁾
Current consumption	≤ 20 mA ²⁾
Switching output	PNP
Output function	Complementary
Switching mode	Light/dark switching
Switching output detail	
Switching output Q1	PNP, Light switching
Switching output Q2	PNP, Dark switching
Output current I_{max}	≤ 100 mA
Response time	≤ 0.5 ms ³⁾
Switching frequency	1,000 Hz ⁴⁾
Connection type	Male connector M8, 4-pin
Cable material	Plastic, PVC
Circuit protection	A ⁵⁾ B ⁶⁾ D ⁷⁾
Protection class	III
Weight	18 g
Housing material	Plastic, VISTAL®
Optics material	Plastic, PMMA
Enclosure rating	IP67 IP69K
Items supplied	Fastening nut (1x), M18, plastic, black, flat
Electromagnetic compatibility (EMC)	EN 60947-5-2 (The sensor complies with the Radio Safety Requirements (EMC) for the industrial sector (Radio Safety Class A). It may cause radio interference if used in a residential area.)
Ambient operating temperature	-30 °C ... +55 °C ⁸⁾
Ambient temperature, storage	-40 °C ... +70 °C

1) May not fall below or exceed U_y tolerances.

2) Without signal strength light bar and load.

3) Signal transit time with resistive load.

4) With light/dark ratio 1:1.

5) A = V_S connections reverse-polarity protected.

6) B = inputs and output reverse-polarity protected.

7) D = outputs overcurrent and short-circuit protected.

8) Below T_a = -10 °C, sensor must be turned on at T_a > -10 °C. Sensor cannot be turned on below T_a = -10 °C.

UL File No.	E189383
--------------------	---------

- 1) May not fall below or exceed U_V tolerances.
- 2) Without signal strength light bar and load.
- 3) Signal transit time with resistive load.
- 4) With light/dark ratio 1:1.
- 5) A = V_S connections reverse-polarity protected.
- 6) B = inputs and output reverse-polarity protected.
- 7) D = outputs overcurrent and short-circuit protected.
- 8) Below $T_a = -10\text{ }^\circ\text{C}$, sensor must be turned on at $T_a > -10\text{ }^\circ\text{C}$. Sensor cannot be turned on below $T_a = -10\text{ }^\circ\text{C}$.

Safety-related parameters

MTTF_D	309 years
DC_{avg}	0 %

Connection type/pinouts

Connection type		Male connector M8, 4-pin
Connection type Detail		
	Cable material	Plastic
Pinouts		
	BN 1	+ (L+)
	WH 2	Q ₂
	BU 3	- (M)
	BK 4	Q ₁

Certificates

EU declaration of conformity	✓
UK declaration of conformity	✓
ACMA declaration of conformity	✓
Moroccan declaration of conformity	✓
China RoHS	✓
cULus certificate	✓

Classifications

ECLASS 5.0	27270904
ECLASS 5.1.4	27270904
ECLASS 6.0	27270904
ECLASS 6.2	27270904
ECLASS 7.0	27270904
ECLASS 8.0	27270904
ECLASS 8.1	27270904
ECLASS 9.0	27270904
ECLASS 10.0	27270904
ECLASS 11.0	27270904
ECLASS 12.0	27270904
ETIM 5.0	EC002719

ETIM 6.0	EC002719
ETIM 7.0	EC002719
ETIM 8.0	EC002719
UNSPSC 16.0901	39121528

Dimensional drawing

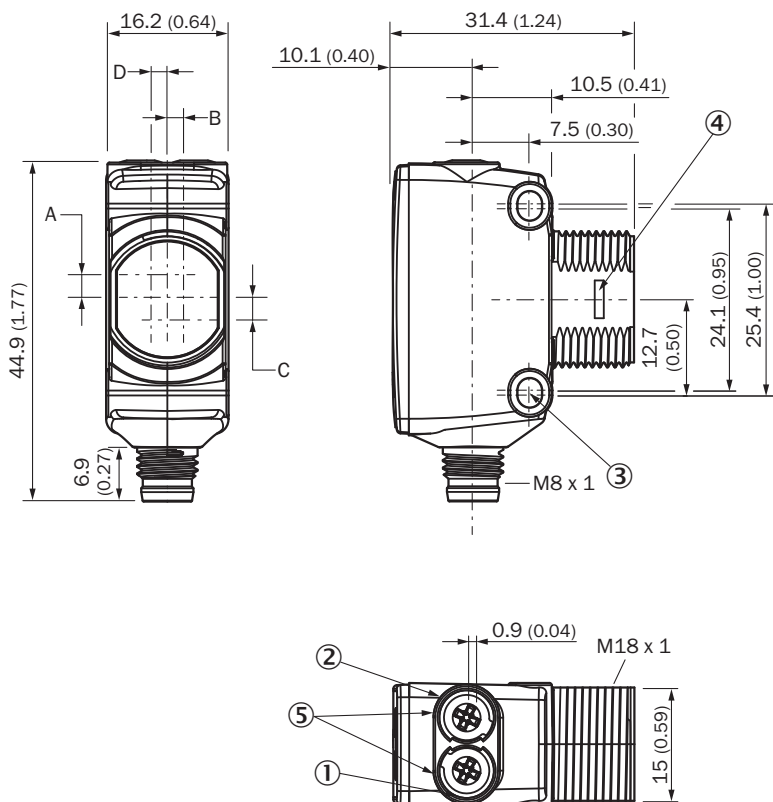

Dimensions in mm (inch)

- ① LED indicator yellow: Status of received light beam
- ② LED indicator green: power on
- ③ M3 mounting hole
- ④ Snap Connection for flush ring (sold seperatly)
- ⑤ Potentiometer (if selected) or LED Indicators

Dimensions in mm (inch)	Receiver		Sender	
	A	B	C	D
-				
HTB18 / HTF18	- 1.1 (0.04)	1.1 (0.04)	4.7 (0.19)	0.6 (0.02)
HTE18 / HL18 / HSE18	2.5 (0.1)	0.0 (0.0)	4.0 (0.16)	0.0 (0.0)
HTB18L / HTF18L / HL18L / HSE18L	2.5 (0.1)	0.0 (0.0)	3.5 (0.14)	0.0 (0.0)

Pinouts, see table Technical data: Connection type/pinouts

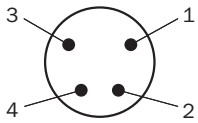

Male connector, M8, 4-pin, uncoded

Characteristic curve

% of sensing range

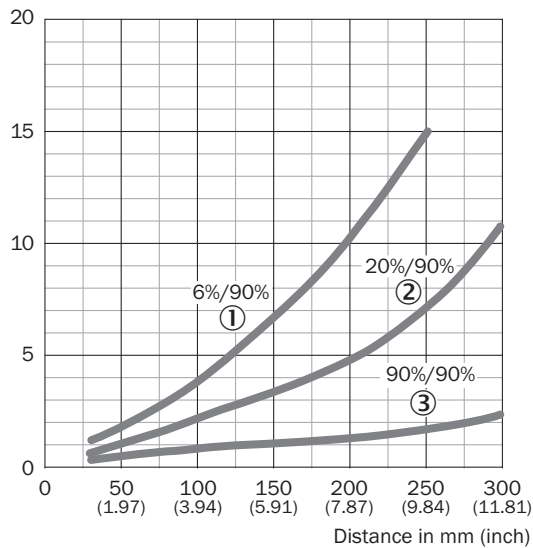

- ① Sensing range on black, 6% remission factor
- ② sensing range to gray, 20% remission factor
- ③ Sensing range on white, 90% remission factor

Light spot size

mm (inch)

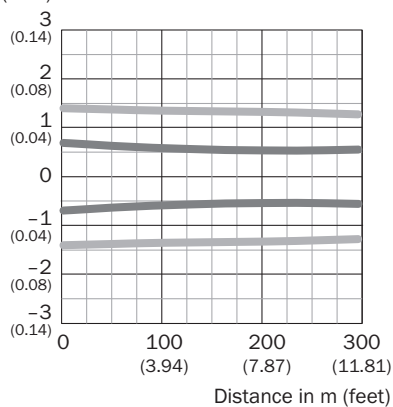

— horizontal
— vertical

Sensing range diagram

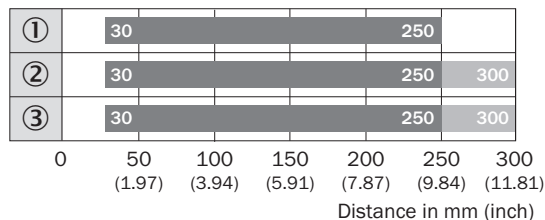



- Sensing range ■ Sensing range max.
- ① Sensing range on black, 6% remission factor
- ② sensing range to gray, 20% remission factor
- ③ Sensing range on white, 90% remission factor

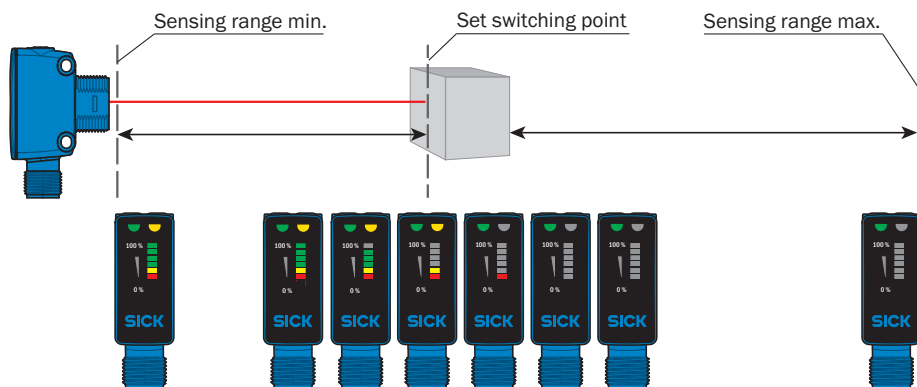

Functions



Recommended accessories

Other models and accessories → www.sick.com/H18_Sure_Sense

	Brief description	Type	part no.
Mounting systems			
	<ul style="list-style-type: none"> • Description: Mounting bracket for M18 sensors • Material: Steel • Details: Steel, zinc coated • Items supplied: Without mounting hardware • Suitable for: GR18, V180-2, V18, W15, Z1, Z2 	BEF-WN-M18	5308446
	<ul style="list-style-type: none"> • Description: Plate N11N for universal clamp bracket • Material: Stainless steel • Details: Stainless steel 1.4571 (sheet), Stainless steel 1.4408 (clamp) • Items supplied: Universal clamp (5322627), mounting hardware • Usable for: DeltaPac, Glare, WTD20E 	BEF-KHS-N11N	2071081

	Brief description	Type	part no.
connectors and cables			
	<ul style="list-style-type: none"> Description: Sensor/actuator cable, unshielded Connection type head A: Female connector, M8, 4-pin, straight, A-coded Connection type head B: Flying leads Signal type: Sensor/actuator cable Cable: 5 m, 4-wire, PVC Application: Uncontaminated zones, Zones with chemicals 	YF8U14-050VA3XLEAX	2095889
	<ul style="list-style-type: none"> Description: Unshielded Connection type head A: Male connector, M8, 4-pin, straight, A-coded Connection systems: Screw-type terminals Permitted cross-section: 0.14 mm² ... 0.5 mm² 	STE-0804-G	6037323
	<ul style="list-style-type: none"> Description: Sensor/actuator cable, unshielded Connection type head A: Female connector, M8, 4-pin, straight, A-coded Connection type head B: Flying leads Signal type: Sensor/actuator cable Cable: 5 m, 4-wire, PUR, halogen-free Application: Drag chain operation, Zones with oils and lubricants, Robot, Drag chain operation 	YF8U14-050UA3XLEAX	2094792

SICK AT A GLANCE

SICK is one of the leading manufacturers of intelligent sensors and sensor solutions for industrial applications. A unique range of products and services creates the perfect basis for controlling processes securely and efficiently, protecting individuals from accidents and preventing damage to the environment.

We have extensive experience in a wide range of industries and understand their processes and requirements. With intelligent sensors, we can deliver exactly what our customers need. In application centers in Europe, Asia and North America, system solutions are tested and optimized in accordance with customer specifications. All this makes us a reliable supplier and development partner.

Comprehensive services complete our offering: SICK LifeTime Services provide support throughout the machine life cycle and ensure safety and productivity.

For us, that is “Sensor Intelligence.”

WORLDWIDE PRESENCE:

Contacts and other locations –www.sick.com