



FUM-H025F1CD50000

DOSIC

FLOW SENSORS

SICK
Sensor Intelligence.



Illustration may differ



Ordering information

Type	part no.
FUM-H025F1CD50000	1082027

Other models and accessories → www.sick.com/DOSIC

Detailed technical data

Features

Measurement principle	Ultrasonic sensor
Medium	Conductive and non-conductive liquids
Nominal width measuring tube	DN 25
Process temperature	-20 °C ... +95 °C, up to 143 °C for 60 minutes for SIP process (temperature measurement only) ¹⁾
Process pressure	-0.5 bar ... 16 bar
Communication interface	IO-Link, IO-Link V1.1
Temperature measurement	✓

¹⁾ 0 °C ... +95 °C with flow and temperature measurement; up to 143 °C only with temperature measurement.

Performance

Minimum flow	1.5 l/min
Inlet zone	5 x DN (12.5 cm)
Output zone	3 x DN (7.5 cm)
Conductivity	No limitation
Measurement accuracy	± 1 % From measured value ¹⁾
Repeatability	0.5 %
Resolution	10 ml/min

¹⁾ Under the following reference conditions: water 26 °C ± 2 K, 2.5 bar ± 0.5 bar, standard settings, DN15: 8 l/min ... 80 l/min, DN25: 25 l/min ... 250 l/min.

Response time	12 ms
----------------------	-------

¹⁾ Under the following reference conditions: water 26 °C ± 2 K, 2.5 bar ± 0.5 bar, standard settings, DN15: 8 l/min ... 80 l/min, DN25: 25 l/min ... 250 l/min.

Electronics

Supply voltage	12 V DC ... 30 V DC ¹⁾
Power consumption	< 3 W without output load
Switch-on time	≤ 5 s
Protection class	✓
Connection type	Round connector M12 x 1, 5-pin
Output signal	1 x analog output: 4 mA ... 20 mA, 2 x digital input or output (configurable) ²⁾ ³⁾
Output load	4 mA ... 20 mA, 500 ohms when U _v > 15 V, 350 ohms when U _v > 12 V
Lower signal level	3.5 mA ... 3.8 mA
Upper signal level	20.5 mA ... 21.5 mA
Digital output	≤ 100 mA
Impulse output signal	50 μs ... 2 s
Impuls/frequency output	0 kHz ... 10 kHz
Inductive load	< 1 H
Capacitive load	< 100 nF < 2.5 nF (IO-Link)
Enclosure rating	IP67 (according to DIN EN 60529) IP69 (according to DIN EN 60529)
EMC	EN 61326-1, EN 61326-2-3
Limit digital inputs	HIGH state voltage > 16.0 V, LOW state voltage < 4.0 V
MTTF	> 63 years

¹⁾ All connections are reverse polarity protected. Q_A is short-circuit protected. Q1 and Q2 are short-circuit protected.

²⁾ Digital output configuration: PNP/NPN/push-pull/open collector.

³⁾ Selectable analog output: flow/temperature.

Mechanics

Process connection	Clamp (DIN 32676) DN 25
Wetted parts	Stainless steel 1.4404 (Ra ≤ 0,8 μm)
Housing material	Stainless steel 1,4305
Housing design	With viewing window made from PMMA (acrylic glass)
Weight	Approx. 3 kg

Ambient data

Ambient operating temperature	0 °C ... +60 °C
Ambient temperature, storage	-40 °C ... +80 °C

Certificates

EU declaration of conformity	✓
UK declaration of conformity	✓
ACMA declaration of conformity	✓
Moroccan declaration of conformity	✓

China RoHS	✓
FDA certificate	✓
cULus certificate	✓
IO-Link certificate	✓
Food contact material manufacturer declaration	✓

Classifications

ECLASS 5.0	27200412
ECLASS 5.1.4	27200412
ECLASS 6.0	27200412
ECLASS 6.2	27200412
ECLASS 7.0	27200412
ECLASS 8.0	27200412
ECLASS 8.1	27200412
ECLASS 9.0	27200412
ECLASS 10.0	27200412
ECLASS 11.0	27200412
ECLASS 12.0	27200412
ETIM 5.0	EC002580
ETIM 6.0	EC002580
ETIM 7.0	EC002580
ETIM 8.0	EC002580
UNSPSC 16.0901	41112501

Dimensional drawing process connection

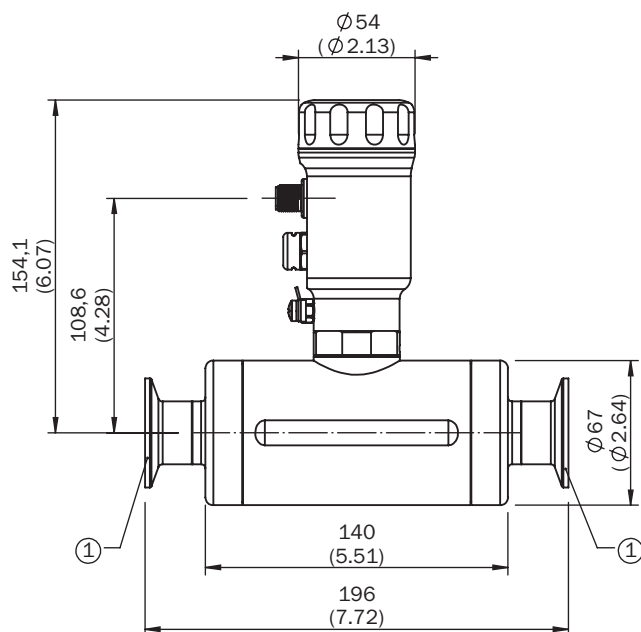

Dimensions in mm (inch)

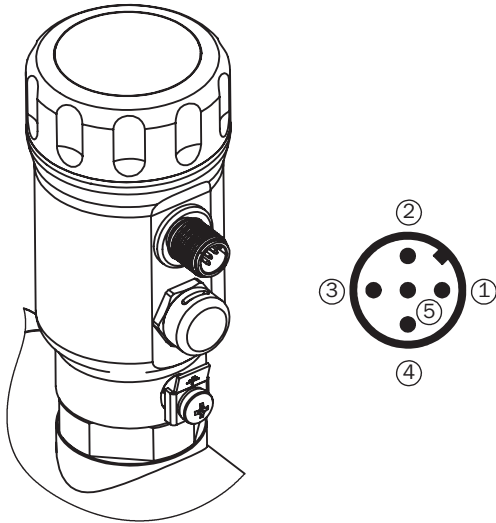

Connection type











- ① L⁺: Supply voltage
- ② Q_A: analog current output 4 mA ... 20 mA
- ③ M: Ground, reference potential for current output
- ④ C/Q1: Switching output/input 1, PNP/NPN/push-pull/open collector/IO-Link communication
- ⑤ Q2: Switching output/input 2, PNP/NPN/push-pull/open collector/frequency/pulse output



Recommended accessories

Other models and accessories → www.sick.com/DOSIC

	Brief description	Type	part no.
device protection and care			
	<ul style="list-style-type: none"> Description: Cover closed, material 1.4305 	Cover closed	2067269
network devices			
		IOLA2US-01101 (SiLink2 Master)	1061790

	Brief description	Type	part no.
connectors and cables			
	<ul style="list-style-type: none"> Description: Sensor/actuator cable, unshielded Connection type head A: Female connector, M12, 5-pin, straight Connection type head B: Flying leads Signal type: Sensor/actuator cable Cable: 2 m, 5-wire, PVC Connection systems: Flying leads Note: This product is generally resistant to chemical cleaning agents (see ECOLAB). Please do not use cleaning agents of any other Kind., Not resistant against lactic acid & hydrogen peroxide (H2O2) Application: Uncontaminated zones, Hygienic and washdown zones, Zones with chemicals 	YF2AP5-020VB5XLEAX	6052625
	<ul style="list-style-type: none"> Description: Sensor/actuator cable, unshielded Connection type head A: Female connector, M12, 5-pin, straight Connection type head B: Flying leads Signal type: Sensor/actuator cable Cable: 5 m, 5-wire, PVC Connection systems: Flying leads Note: This product is generally resistant to chemical cleaning agents (see ECOLAB). Please do not use cleaning agents of any other Kind., Not resistant against lactic acid & hydrogen peroxide (H2O2) Application: Uncontaminated zones, Hygienic and washdown zones, Zones with chemicals 	YF2AP5-050VB5XLEAX	6052626
	<ul style="list-style-type: none"> Description: Sensor/actuator cable, unshielded Connection type head A: Female connector, M12, 5-pin, straight Connection type head B: Flying leads Signal type: Sensor/actuator cable Cable: 10 m, 5-wire, PVC Connection systems: Flying leads Note: This product is generally resistant to chemical cleaning agents (see ECOLAB). Please do not use cleaning agents of any other Kind., Not resistant against lactic acid & hydrogen peroxide (H2O2) Application: Uncontaminated zones, Hygienic and washdown zones, Zones with chemicals 	YF2AP5-100VB5XLEAX	6052627
	<ul style="list-style-type: none"> Description: Sensor/actuator cable, unshielded Connection type head A: Female connector, M12, 5-pin, angled, A-coded Connection type head B: Flying leads Signal type: Sensor/actuator cable Cable: 2 m, 5-wire, PVC Application: Uncontaminated zones, Zones with chemicals 	YG2A15-020VB5XLEAX	2096215
	<ul style="list-style-type: none"> Description: Sensor/actuator cable, unshielded Connection type head A: Female connector, M12, 5-pin, angled, A-coded Connection type head B: Flying leads Signal type: Sensor/actuator cable Cable: 5 m, 5-wire, PVC Application: Uncontaminated zones, Zones with chemicals 	YG2A15-050VB5XLEAX	2096216
	<ul style="list-style-type: none"> Description: Sensor/actuator cable, unshielded Connection type head A: Female connector, M12, 5-pin, angled, A-coded Connection type head B: Flying leads Signal type: Sensor/actuator cable Cable: 10 m, 5-wire, PVC Application: Uncontaminated zones, Zones with chemicals 	YG2A15-100VB5XLEAX	2096217
	<ul style="list-style-type: none"> Description: Sensor/actuator cable, unshielded Connection type head A: Female connector, M12, 5-pin, straight, A-coded Connection type head B: Flying leads Signal type: Sensor/actuator cable Cable: 2 m, 5-wire, PUR, halogen-free Application: Drag chain operation, Zones with oils and lubricants, Robot, Drag chain operation 	YF2A15-020UB5XLEAX	2095617
	<ul style="list-style-type: none"> Description: Sensor/actuator cable, unshielded Connection type head A: Female connector, M12, 5-pin, straight, A-coded Connection type head B: Flying leads Signal type: Sensor/actuator cable Cable: 5 m, 5-wire, PUR, halogen-free Application: Drag chain operation, Zones with oils and lubricants, Robot, Drag chain operation 	YF2A15-050UB5XLEAX	2095618
	<ul style="list-style-type: none"> Description: Sensor/actuator cable, unshielded Connection type head A: Female connector, M12, 5-pin, straight, A-coded Connection type head B: Flying leads Signal type: Sensor/actuator cable Cable: 10 m, 5-wire, PUR, halogen-free 	YF2A15-100UB5XLEAX	2095619

	Brief description	Type	part no.
	<ul style="list-style-type: none"> • Application: Drag chain operation, Zones with oils and lubricants, Robot, Drag chain operation • Description: Sensor/actuator cable, unshielded • Connection type head A: Female connector, M12, 5-pin, angled, A-coded • Connection type head B: Flying leads • Signal type: Sensor/actuator cable • Cable: 2 m, 5-wire, PUR, halogen-free • Application: Drag chain operation, Zones with oils and lubricants, Robot, Drag chain operation 	YG2A15-020UB5XLEAX	2095772
	<ul style="list-style-type: none"> • Description: Sensor/actuator cable, unshielded • Connection type head A: Female connector, M12, 5-pin, angled, A-coded • Connection type head B: Flying leads • Signal type: Sensor/actuator cable • Cable: 5 m, 5-wire, PUR, halogen-free • Application: Drag chain operation, Zones with oils and lubricants, Robot, Drag chain operation 	YG2A15-050UB5XLEAX	2095773
	<ul style="list-style-type: none"> • Description: Sensor/actuator cable, unshielded • Connection type head A: Female connector, M12, 5-pin, angled, A-coded • Connection type head B: Flying leads • Signal type: Sensor/actuator cable • Cable: 10 m, 5-wire, PUR, halogen-free • Application: Drag chain operation, Zones with oils and lubricants, Robot, Drag chain operation 	YG2A15-100UB5XLEAX	2095774
	<ul style="list-style-type: none"> • Description: Sensor/actuator cable, unshielded • Connection type head A: Female connector, M12, 5-pin, straight, A-coded • Connection type head B: Flying leads • Signal type: Sensor/actuator cable • Cable: 2 m, 5-wire, PVC • Application: Uncontaminated zones, Zones with chemicals 	YF2A15-020VB5XLEAX	2096239
	<ul style="list-style-type: none"> • Description: Sensor/actuator cable, unshielded • Connection type head A: Female connector, M12, 5-pin, straight, A-coded • Connection type head B: Flying leads • Signal type: Sensor/actuator cable • Cable: 5 m, 5-wire, PVC • Application: Uncontaminated zones, Zones with chemicals 	YF2A15-050VB5XLEAX	2096240
	<ul style="list-style-type: none"> • Description: Sensor/actuator cable, unshielded • Connection type head A: Female connector, M12, 5-pin, straight, A-coded • Connection type head B: Flying leads • Signal type: Sensor/actuator cable • Cable: 10 m, 5-wire, PVC • Application: Uncontaminated zones, Zones with chemicals 	YF2A15-100VB5XLEAX	2096241
	<ul style="list-style-type: none"> • Description: Sensor/actuator cable, unshielded • Connection type head A: Female connector, M12, 5-pin, angled, A-coded • Connection type head B: Flying leads • Signal type: Sensor/actuator cable • Cable: 0.6 m, 5-wire, PUR, halogen-free • Application: Drag chain operation, Zones with oils and lubricants, Robot, Drag chain operation 	YG2A15-C60UB5XLEAX	2145540
	<ul style="list-style-type: none"> • Description: Sensor/actuator cable, unshielded • Connection type head A: Female connector, M12, 5-pin, angled, A-coded • Connection type head B: Flying leads • Signal type: Sensor/actuator cable • Cable: 3 m, 5-wire, PUR, halogen-free • Application: Drag chain operation, Zones with oils and lubricants, Robot, Drag chain operation 	YG2A15-030UB5XLEAX	2145543
	<ul style="list-style-type: none"> • Description: Sensor/actuator cable, unshielded • Connection type head A: Female connector, M12, 5-pin, angled, A-coded • Connection type head B: Flying leads • Signal type: Sensor/actuator cable • Cable: 1 m, 5-wire, PUR, halogen-free • Application: Drag chain operation, Zones with oils and lubricants, Robot, Drag chain operation 	YG2A15-010UB5XLEAX	2145541
	<ul style="list-style-type: none"> • Description: Sensor/actuator cable, unshielded • Connection type head A: Female connector, M12, 5-pin, angled, A-coded • Connection type head B: Flying leads • Signal type: Sensor/actuator cable • Cable: 0.6 m, 5-wire, PVC • Application: Uncontaminated zones, Zones with chemicals 	YG2A15-C60VB5XLEAX	2145573
	<ul style="list-style-type: none"> • Description: Sensor/actuator cable, unshielded • Connection type head A: Female connector, M12, 5-pin, angled, A-coded • Connection type head B: Flying leads • Signal type: Sensor/actuator cable • Cable: 1 m, 5-wire, PVC 	YG2A15-010VB5XLEAX	2145574

	Brief description	Type	part no.
	<ul style="list-style-type: none"> • Application: Untaminated zones, Zones with chemicals • Description: Sensor/actuator cable, unshielded • Connection type head A: Female connector, M12, 5-pin, angled, A-coded • Connection type head B: Flying leads • Signal type: Sensor/actuator cable • Cable: 3 m, 5-wire, PVC • Application: Untaminated zones, Zones with chemicals 	YG2A15-030VB5XLEAX	2145575
	<ul style="list-style-type: none"> • Description: Sensor/actuator cable, unshielded • Connection type head A: Female connector, M12, 5-pin, straight, A-coded • Connection type head B: Flying leads • Signal type: Sensor/actuator cable • Cable: 0.6 m, 5-wire, PVC • Application: Untaminated zones, Zones with chemicals 	YF2A15-C60VB5XLEAX	2145570
	<ul style="list-style-type: none"> • Description: Sensor/actuator cable, unshielded • Connection type head A: Female connector, M12, 5-pin, straight, A-coded • Connection type head B: Flying leads • Signal type: Sensor/actuator cable • Cable: 3 m, 5-wire, PVC • Application: Untaminated zones, Zones with chemicals 	YF2A15-030VB5XLEAX	2145572

SICK AT A GLANCE

SICK is one of the leading manufacturers of intelligent sensors and sensor solutions for industrial applications. A unique range of products and services creates the perfect basis for controlling processes securely and efficiently, protecting individuals from accidents and preventing damage to the environment.

We have extensive experience in a wide range of industries and understand their processes and requirements. With intelligent sensors, we can deliver exactly what our customers need. In application centers in Europe, Asia and North America, system solutions are tested and optimized in accordance with customer specifications. All this makes us a reliable supplier and development partner.

Comprehensive services complete our offering: SICK LifeTime Services provide support throughout the machine life cycle and ensure safety and productivity.

For us, that is “Sensor Intelligence.”

WORLDWIDE PRESENCE:

Contacts and other locations –www.sick.com