



HL18T-N4B3BB

H18 Sure Sense

PHOTOELECTRIC SENSORS

SICK
Sensor Intelligence.



Illustration may differ



Ordering information

| Type | part no. |
|--------------|----------|
| HL18T-N4B3BB | 1081806 |

Other models and accessories → www.sick.com/H18_Sure_Sense

Detailed technical data

Features

| | | |
|--|---|-------------|
| Functional principle | Photoelectric retro-reflective sensor | |
| Functional principle detail | With minimum distance to reflector (dual lens system) | |
| Dimensions (W x H x D) | 16.2 mm x 45.5 mm x 31.8 mm | |
| Housing design (light emission) | Hybrid | |
| Thread diameter (housing) | M18 | |
| Mounting system type | M18, head/side (24.1 ... 25.4 mm) | |
| Housing color | Blue | |
| Sensing range max. | 0.1 m ... 3 m ¹⁾ | |
| Sensing range | 0.1 m ... 2.5 m ¹⁾ | |
| Type of light | Visible red light | |
| Light source | PinPoint LED ²⁾ | |
| Light spot size (distance) | 60 mm x 120 mm (3 m) | |
| Wave length | 631 nm | |
| Adjustment | | |
| | Potentiometer, right | Sensitivity |
| | Potentiometer, left | None |
| Special applications | Detecting transparent objects | |
| Special features | Signal strength light bar | |

¹⁾ Reflector PL80A.

²⁾ Average service life: 100,000 h at T_U = +25 °C.

Mechanics/electronics

| | |
|---|--|
| Supply voltage | 10 V DC ... 30 V DC |
| Ripple | $< 5 V_{pp}^{1)}$ |
| Current consumption | $\leq 20 \text{ mA}^{2)}$ |
| Switching output | NPN |
| Output function | Complementary |
| Switching mode | Light/dark switching |
| Switching output detail | |
| Switching output Q1 | NPN, Light switching |
| Switching output Q2 | NPN, Dark switching |
| Output current $I_{max.}$ | $\leq 100 \text{ mA}$ |
| Response time | $\leq 0.5 \text{ ms}^{3)}$ |
| Switching frequency | $1,000 \text{ Hz}^{4)}$ |
| Connection type | Cable with M12 male connector, 4-pin, 150 mm |
| Cable material | Plastic, PVC |
| Conductor cross section | 0.2 mm^2 |
| Circuit protection | A ⁵⁾ B ⁶⁾ D ⁷⁾ |
| Protection class | III |
| Weight | 18 g |
| Polarizing filter | ✓ |
| Housing material | Plastic, VISTAL® |
| Optics material | Plastic, PMMA |
| Enclosure rating | IP67 IP69K |
| Items supplied | Fastening nut (1x), M18, plastic, black, flat |
| Electromagnetic compatibility (EMC) | EN 60947-5-2 (The sensor complies with the Radio Safety Requirements (EMC) for the industrial sector (Radio Safety Class A). It may cause radio interference if used in a residential area.) |
| Ambient operating temperature | $-40 \text{ °C} \dots +70 \text{ °C}$ |
| Ambient temperature, storage | $-40 \text{ °C} \dots +75 \text{ °C}$ |
| UL File No. | E189383 |

¹⁾ May not fall below or exceed U_y tolerances.

²⁾ Without signal strength light bar and load.

³⁾ Signal transit time with resistive load.

⁴⁾ With light/dark ratio 1:1.

⁵⁾ A = V_S connections reverse-polarity protected.

⁶⁾ B = inputs and output reverse-polarity protected.

⁷⁾ D = outputs overcurrent and short-circuit protected.

Safety-related parameters

| | |
|-------------------------|-------------|
| MTTF_D | 730.1 years |
| DC_{avg} | 0 % |

Connection type/pinouts

| | | |
|-------------------------------|-------------------------|--|
| Connection type | | Cable with M12 male connector, 4-pin, 150 mm |
| Connection type Detail | | |
| | Cable material | Plastic |
| | Conductor cross section | 0.2 mm ² |
| Pinouts | | |
| | BN 1 | + (L+) |
| | WH 2 | Q ₂ |
| | BU 3 | - (M) |
| | BK 4 | Q ₁ |

Certificates

| | |
|---|---|
| EU declaration of conformity | ✓ |
| UK declaration of conformity | ✓ |
| ACMA declaration of conformity | ✓ |
| Moroccan declaration of conformity | ✓ |
| China RoHS | ✓ |
| cULus certificate | ✓ |

Classifications

| | |
|-----------------------|----------|
| ECLASS 5.0 | 27270902 |
| ECLASS 5.1.4 | 27270902 |
| ECLASS 6.0 | 27270902 |
| ECLASS 6.2 | 27270902 |
| ECLASS 7.0 | 27270902 |
| ECLASS 8.0 | 27270902 |
| ECLASS 8.1 | 27270902 |
| ECLASS 9.0 | 27270902 |
| ECLASS 10.0 | 27270902 |
| ECLASS 11.0 | 27270902 |
| ECLASS 12.0 | 27270902 |
| ETIM 5.0 | EC002717 |
| ETIM 6.0 | EC002717 |
| ETIM 7.0 | EC002717 |
| ETIM 8.0 | EC002717 |
| UNSPSC 16.0901 | 39121528 |

Dimensional drawing

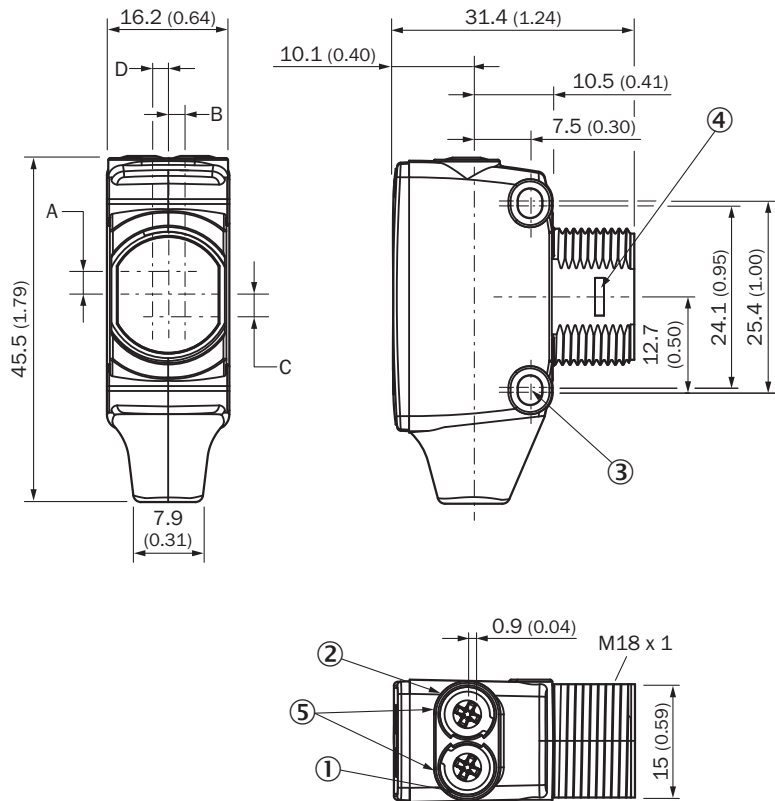

Dimensions in mm (inch)

- ① LED indicator yellow: Status of received light beam
- ② LED indicator green: power on
- ③ M3 mounting hole
- ④ Snap Connection for flush ring (sold seperatly)
- ⑤ Potentiometer (if selected) or LED Indicators

| Dimensions in mm (inch) | Receiver | | Sender | |
|----------------------------------|--------------|------------|------------|------------|
| | A | B | C | D |
| HTB18 / HTF18 | - 1.1 (0.04) | 1.1 (0.04) | 4.7 (0.19) | 0.6 (0.02) |
| HTE18 / HL18 / HSE18 | 2.5 (0.1) | 0.0 (0.0) | 4.0 (0.16) | 0.0 (0.0) |
| HTB18L / HTF18L / HL18L / HSE18L | 2.5 (0.1) | 0.0 (0.0) | 3.5 (0.14) | 0.0 (0.0) |

Adjustments

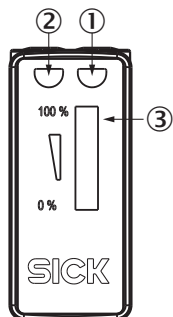

- ① LED indicator yellow: Status of received light beam
- ② LED indicator green: power on
- ③ Signal strength light bar

Pinouts, see table [Technical data: Connection type/pinouts](#)

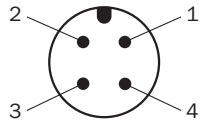

M12 male connector, 4-pin, A-coding

Characteristic curve

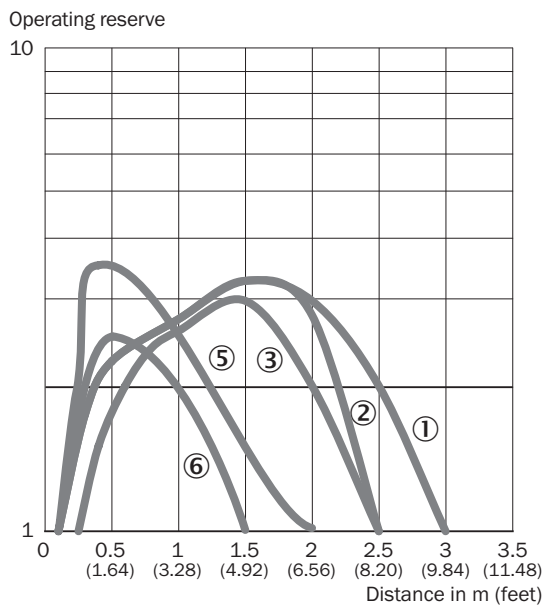

- ① Reflector PL80A
- ② Reflector PL40A
- ③ Reflector P250F
- ⑤ Reflective tape REF-AC1000
- ⑥ Reflector PL41F

Light spot size

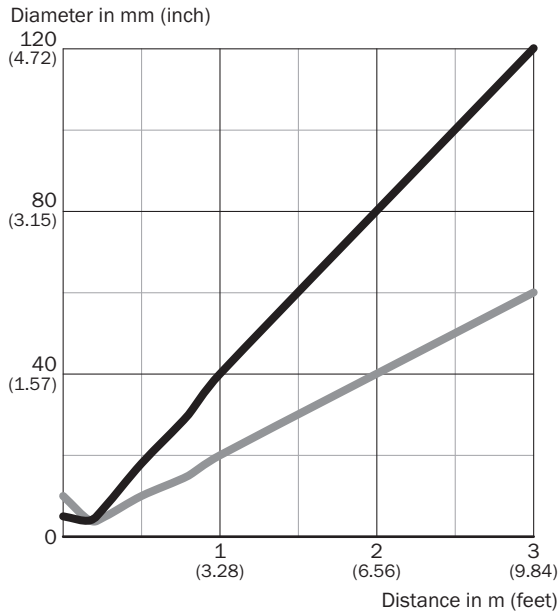

Dimensions in mm (inch)

| Sensing range | Vertical | Horizontal |
|------------------------------------|---------------|--------------|
| 0.5 m (1.64 feet) | 18 (0.71) | 10 (0.39) |
| 0.8 m (2.62 feet) | 30 (1.18) | 15 (0.59) |
| 1 m (3.28 feet) | 40 (1.57) | 20 (0.79) |
| 3 m (9.84 feet) | 120 (4.72) | 60 (2.36) |

— Vertical
— Horizontal

Sensing range diagram

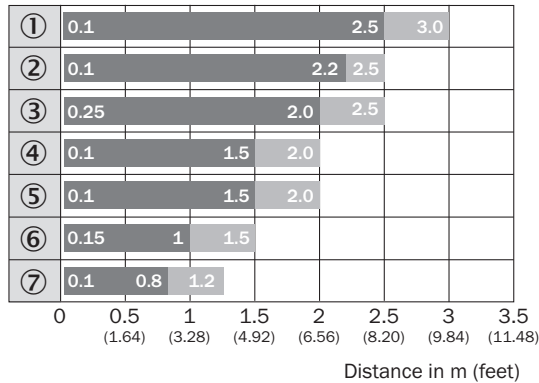

■ Sensing range ■ Sensing range max.



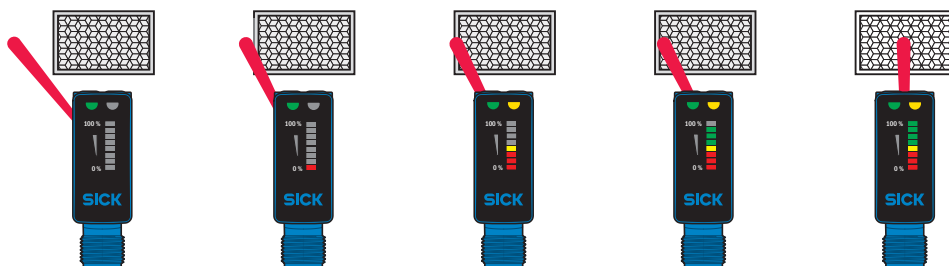

- ① Reflector PL80A
- ② Reflector PL40A
- ③ Reflector P250F
- ④ Reflector PL30A, PL31A
- ⑤ Reflective tape REF-AC1000
- ⑥ Reflector PL41F
- ⑦ Reflector PL20A



Functions



Recommended accessories

Other models and accessories → www.sick.com/H18_Sure_Sense

| | Brief description | Type | part no. |
|---|---|--------------|----------|
| Mounting systems | | | |
|  | <ul style="list-style-type: none"> Description: Mounting bracket for M18 sensors Material: Steel Details: Steel, zinc coated Items supplied: Without mounting hardware Suitable for: GR18, V180-2, V18, W15, Z1, Z2 | BEF-WN-M18 | 5308446 |
|  | <ul style="list-style-type: none"> Description: Universal mounting bracket for reflectors Dimensions (W x H x L): 85 mm x 90 mm x 35 mm Material: Steel Details: Steel, zinc coated Suitable for: C110A, P250, PL20, PL30A, PL40A, PL80A | BEF-WN-REFX | 2064574 |
|  | <ul style="list-style-type: none"> Description: Plate N11N for universal clamp bracket Material: Stainless steel Details: Stainless steel 1.4571 (sheet), Stainless steel 1.4408 (clamp) Items supplied: Universal clamp (5322627), mounting hardware Usable for: DeltaPac, Glare, WTD20E | BEF-KHS-N11N | 2071081 |
| reflectors and optics | | | |
|  | <ul style="list-style-type: none"> Description: Rectangular, screw connection Dimensions: 51 mm 61 mm Ambient operating temperature: -30 °C ... +65 °C | P250 | 5304812 |

| | Brief description | Type | part no. |
|---|--|--------------------|----------|
| connectors and cables | | | |
|  | <ul style="list-style-type: none"> • Description: Sensor/actuator cable, unshielded • Connection type head A: Female connector, M12, 4-pin, straight, A-coded • Connection type head B: Flying leads • Signal type: Sensor/actuator cable • Cable: 5 m, 4-wire, PVC • Application: Uncontaminated zones, Zones with chemicals | YF2A14-050VB3XLEAX | 2096235 |
|  | <ul style="list-style-type: none"> • Description: Unshielded • Connection type head A: Male connector, M12, 4-pin, straight, A-coded • Connection systems: Screw-type terminals • Permitted cross-section: ≤ 0.75 mm² | STE-1204-G | 6009932 |
|  | <ul style="list-style-type: none"> • Description: Sensor/actuator cable, unshielded • Connection type head A: Female connector, M12, 4-pin, straight, A-coded • Connection type head B: Flying leads • Signal type: Sensor/actuator cable • Cable: 5 m, 4-wire, PUR, halogen-free • Application: Drag chain operation, Zones with oils and lubricants, Robot, Drag chain operation | YF2A14-050UB3XLEAX | 2095608 |

SICK AT A GLANCE

SICK is one of the leading manufacturers of intelligent sensors and sensor solutions for industrial applications. A unique range of products and services creates the perfect basis for controlling processes securely and efficiently, protecting individuals from accidents and preventing damage to the environment.

We have extensive experience in a wide range of industries and understand their processes and requirements. With intelligent sensors, we can deliver exactly what our customers need. In application centers in Europe, Asia and North America, system solutions are tested and optimized in accordance with customer specifications. All this makes us a reliable supplier and development partner.

Comprehensive services complete our offering: SICK LifeTime Services provide support throughout the machine life cycle and ensure safety and productivity.

For us, that is “Sensor Intelligence.”

WORLDWIDE PRESENCE:

Contacts and other locations –www.sick.com