



# KTM-WP1A282V

KTM

CONTRAST SENSORS

**SICK**  
Sensor Intelligence.



Illustration may differ



### Ordering information

| Type         | part no. |
|--------------|----------|
| KTM-WP1A282V | 1081373  |

Other models and accessories → [www.sick.com/KTM](http://www.sick.com/KTM)

### Detailed technical data

#### Features

|                                   |   |
|-----------------------------------|---|
| <b>Housing design</b>             | Small, stainless steel  |
| <b>Dimensions (W x H x D)</b>     | 15.25 mm x 48.6 mm x 22.2 mm  |
| <b>Light source</b>               | LED, RGB <sup>1)</sup>  |
| <b>Light emission</b>             | Long side of housing  |
| <b>Light spot size</b>            | 1.6 mm x 9.5 mm   |
| <b>Light spot direction</b>       | Vertical <sup>2)</sup>  |
| <b>Receiving filters</b>          | None  |
| <b>Wave length</b>                | 470 nm, 525 nm, 625 nm  |
| <b>Sensing distance</b>           | ≤ 11 mm   |
| <b>Sensing distance tolerance</b> | ± 3 mm  |
| <b>Display</b>                    | LED indicator green: power on<br>LED indicator, yellow: Status switching output Q |
| <b>Adjustment</b>                 | Teach-in button   |
| <b>Teach-in mode</b>              | 2-point teach-in static/dynamic + proximity to mark<br>ET: Teach-in dynamic       |

<sup>1)</sup> Average service life: 100,000 h at T<sub>J</sub> = +25 °C.

<sup>2)</sup> In relation to long side of housing.

## Electronics

|  |   |
|--|---|
| <b>Supply voltage</b>                      | 12 V DC ... 24 V DC <sup>1)</sup>   |
| <b>Ripple</b>                              | $\leq 5 V_{pp}$ <sup>2)</sup>   |
| <b>Current consumption</b>                 | $< 50 \text{ mA}$ <sup>3)</sup>   |
| <b>Switching frequency</b>                 | 15 kHz <sup>4)</sup>  |
| <b>Response time</b>                       | 35 $\mu\text{s}$  |
| <b>Jitter</b>                              | 15 $\mu\text{s}$  |
| <b>Switching output</b>                    | PNP   |
| <b>Switching output (voltage)</b>          | PNP: HIGH = $U_V \leq 2 \text{ V}$ / LOW approx. 0 V  |
| <b>Switching mode</b>                      | Light/dark switching  |
| <b>Output current <math>I_{max}</math></b> | 50 mA <sup>5)</sup>   |
| <b>Input, dynamic teach-in (ET)</b>        | PNP: Teach: $U = 10,8 \text{ V} \dots < U_V$<br>PNP: Run: $U < 2 \text{ V}$ or open                                 |
| <b>Retention time (ET)</b>                 | 28 ms, non-volatile memory  |
| <b>Time delay</b>                          | Switch-off delay, 32 ms   |
| <b>Protection class</b>                    | III   |
| <b>Circuit protection</b>                  | $U_V$ connections, reverse polarity protected<br>Output Q short-circuit protected<br>Interference pulse suppression |
| <b>Connection type</b>                     | Cable with M12 male connector, 4-pin, 0.2 m   |

<sup>1)</sup> Limit values: DC 12 V (-10 %) ... DC 24 V (+20 %). Operation in short-circuit protected network max. 8 A.

<sup>2)</sup> May not fall below or exceed  $U_V$  tolerances.

<sup>3)</sup> Without load.

<sup>4)</sup> With light/dark ratio 1:1.

<sup>5)</sup> Total current of all Outputs.

## Mechanics

|                         |      |
|-------------------------|------|
| <b>Housing material</b> | ABS  |
| <b>Optics material</b>  | PMMA |
| <b>Weight</b>           | 40 g |

## Ambient data

|                                      |                              |
|--------------------------------------|------------------------------|
| <b>Ambient operating temperature</b> | -30 °C ... +70 °C            |
| <b>Ambient temperature, storage</b>  | -30 °C ... +75 °C            |
| <b>Shock load</b>                    | According to IEC 60068       |
| <b>Enclosure rating</b>              | IP69K                        |
| <b>UL File No.</b>                   | NRKH.E348498 & NRKH7.E348498 |

## Connection type/pinouts

|                        |   |
|------------------------|---|
| <b>Connection type</b> | Cable with M12 male connector, 4-pin, 0.2 m |
| <b>Pinouts</b>         | BN 1 + (L+)<br>WH 2 ET                      |

|  |      |       |
|--|------|-------|
|  | BU 3 | - (M) |
|  | BK 4 | Q     |

Certificates

|  |   |
|--|---|
| <b>EU declaration of conformity</b>          | ✓ |
| <b>UK declaration of conformity</b>          | ✓ |
| <b>ACMA declaration of conformity</b>        | ✓ |
| <b>Moroccan declaration of conformity</b>    | ✓ |
| <b>China RoHS</b>                            | ✓ |
| <b>ECOLAB certificate</b>                    | ✓ |
| <b>cULus certificate</b>                     | ✓ |
| <b>Photobiological safety (IEC EN 62471)</b> | ✓ |

Classifications

|                       |          |
|-----------------------|----------|
| <b>ECLASS 5.0</b>     | 27270906 |
| <b>ECLASS 5.1.4</b>   | 27270906 |
| <b>ECLASS 6.0</b>     | 27270906 |
| <b>ECLASS 6.2</b>     | 27270906 |
| <b>ECLASS 7.0</b>     | 27270906 |
| <b>ECLASS 8.0</b>     | 27270906 |
| <b>ECLASS 8.1</b>     | 27270906 |
| <b>ECLASS 9.0</b>     | 27270906 |
| <b>ECLASS 10.0</b>    | 27270906 |
| <b>ECLASS 11.0</b>    | 27270906 |
| <b>ECLASS 12.0</b>    | 27270906 |
| <b>ETIM 5.0</b>       | EC001820 |
| <b>ETIM 6.0</b>       | EC001820 |
| <b>ETIM 7.0</b>       | EC001820 |
| <b>ETIM 8.0</b>       | EC001820 |
| <b>UNSPSC 16.0901</b> | 39121528 |

Dimensional drawing KTM-Wxxxx2V

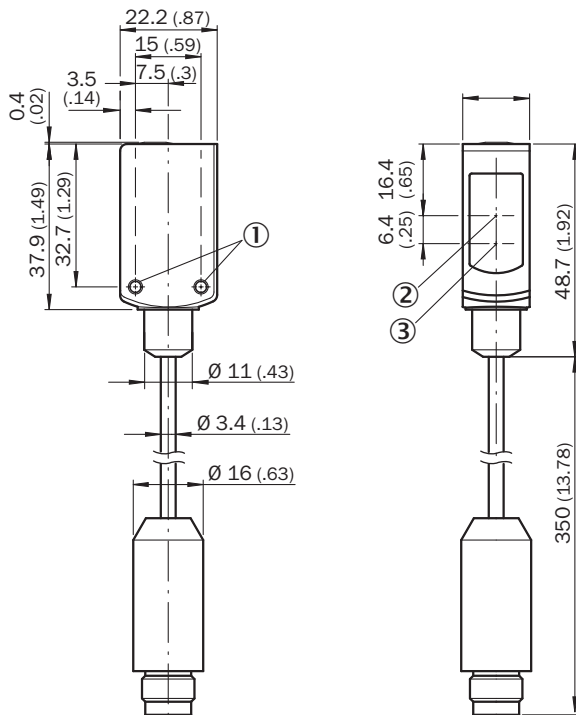

Dimensions in mm (inch)

- ① M3 mounting hole
- ② optical axis, receiver
- ③ optical axis, sender

Pinouts, see table Technical data: Connection type/pinouts

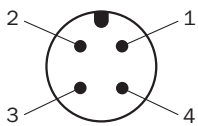

M12 male connector, 4-pin, A-coding

display and adjustment elements

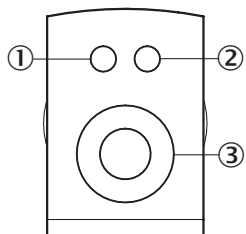

- ① LED yellow
- ② LED green
- ③ Teach-in button

Concept of operation

**1. Position mark**

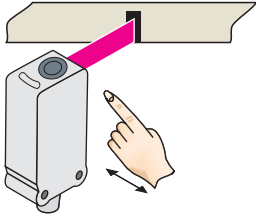

Press and hold teach-in  
button  $> 1 < 3$  s.  
Yellow LED flashes slowly.

**2. Position background**

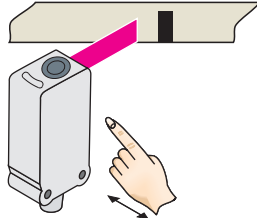

Press and hold teach-in  
button  $< 3$  s.  
Yellow LED goes out.

## Concept of operation Teach-in dynamic

### 1. Position background

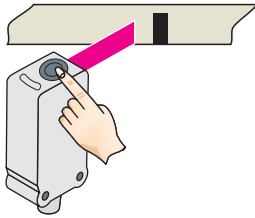

Press the teach-in button and keep it pressed. LED flashing slowly.

### 2. Move at least the mark and background using the light spot.

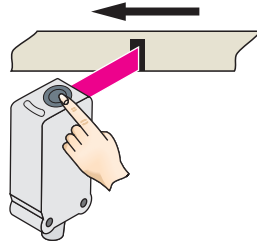

Keep the teach-in button > 3 < 30 s pressed.

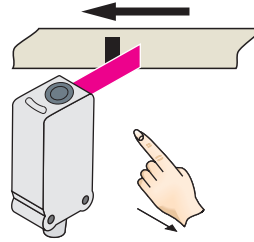

Release the teach-in button.

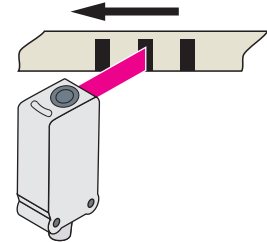

Yellow LED will illuminate, when emitted light is on the mark.

### Example

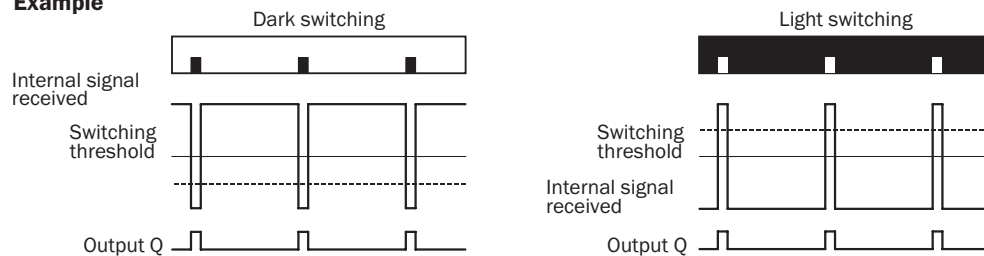

### Switching characteristics

The optimum emitted light is selected automatically (at RGB variants).

Static teach-in: light/dark setting is defined using teach-in sequence.

Dynamic teach-in: switching output active on mark, if background is longer in the field of view during the teach-in.

The switching threshold is set in the center between the background and the mark.

If the button is pressed again within 10 s of the teach (> 20 ms < 10 s), the switching threshold is placed 25 % below the mark (dotted line in Figure).

Teach-in can also be performed using an external control signal (only dynamic teach-in).

Keylock activation and deactivation: hold down teach-in button > 30 s.

Teach-in failure: yellow LED indicator and the transmitted light of the sensor flashing quickly.

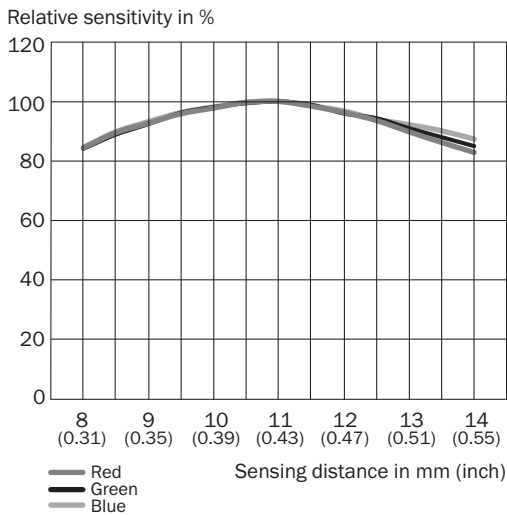

For dynamic teach-in with ET signal (5 Hz) via switching output Q.

Sensing distance



Recommended accessories

Other models and accessories → [www.sick.com/KTM](http://www.sick.com/KTM)

|   | Brief description   | Type               | part no. |
|---|---|--------------------|----------|
| <b>Mounting systems</b>   |   |                    |          |
|  | <ul style="list-style-type: none"> <li><b>Description:</b> Mounting bracket for wall mounting</li> <li><b>Material:</b> Stainless steel</li> <li><b>Details:</b> Stainless steel 1.4571</li> <li><b>Items supplied:</b> Mounting hardware included</li> <li><b>Suitable for:</b> W4S, W4F, W4S</li> </ul>   | BEF-W4-A           | 2051628  |
| <b>connectors and cables</b>  |   |                    |          |
|  | <ul style="list-style-type: none"> <li><b>Description:</b> Sensor/actuator cable, unshielded</li> <li><b>Connection type head A:</b> Female connector, M12, 4-pin, straight, A-coded</li> <li><b>Connection type head B:</b> Male connector, M12, 4-pin, straight, A-coded</li> <li><b>Signal type:</b> Sensor/actuator cable</li> <li><b>Cable:</b> 5 m, 4-wire, PVC</li> <li><b>Application:</b> Untaminated zones, Zones with chemicals</li> </ul> | YF2A14-050VB3M2A14 | 2096600  |
|  | <ul style="list-style-type: none"> <li><b>Description:</b> Sensor/actuator cable, unshielded</li> <li><b>Connection type head A:</b> Female connector, M12, 4-pin, straight, A-coded</li> <li><b>Connection type head B:</b> Flying leads</li> <li><b>Signal type:</b> Sensor/actuator cable</li> <li><b>Cable:</b> 5 m, 4-wire, PVC</li> <li><b>Application:</b> Untaminated zones, Zones with chemicals</li> </ul>                                  | YF2A14-050VB3XLEAX | 2096235  |

## SICK AT A GLANCE

SICK is one of the leading manufacturers of intelligent sensors and sensor solutions for industrial applications. A unique range of products and services creates the perfect basis for controlling processes securely and efficiently, protecting individuals from accidents and preventing damage to the environment.

We have extensive experience in a wide range of industries and understand their processes and requirements. With intelligent sensors, we can deliver exactly what our customers need. In application centers in Europe, Asia and North America, system solutions are tested and optimized in accordance with customer specifications. All this makes us a reliable supplier and development partner.

Comprehensive services complete our offering: SICK LifeTime Services provide support throughout the machine life cycle and ensure safety and productivity.

For us, that is “Sensor Intelligence.”

## WORLDWIDE PRESENCE:

Contacts and other locations –[www.sick.com](http://www.sick.com)