



WTB4SLC-3P2262A70

W4

PHOTOELECTRIC SENSORS

SICK
Sensor Intelligence.



Illustration may differ



Ordering information

Type	part no.
WTB4SLC-3P2262A70	1080940

Other models and accessories → www.sick.com/W4

Detailed technical data

Features

Functional principle	Photoelectric proximity sensor
Functional principle detail	Background suppression
Sensing range max.	25 mm ... 300 mm ¹⁾
Sensing range	25 mm ... 300 mm ¹⁾
Emitted beam	
Light source	Laser ²⁾
Type of light	Visible red light
Light spot size (distance)	Ø 1 mm (170 mm)
Key laser figures	
Normative reference	EN 60825-1:2014, IEC 60825-1:2014 / CDRH 21 CFR 1040.10 & 1040.11
Laser class	1 ³⁾
Wave length	650 nm
Adjustment	Cable, Single teach-in button
Special applications	Detecting small objects
Mounting hole	M3
Pin 2 configuration	External input, Teach-in input, Sender off input, Detection output, logic output

¹⁾ Object with 90% remission (based on standard white, DIN 5033).

²⁾ Average service life: 50,000 h at T_U = +25 °C.

³⁾ Do not intentionally look into the laser beam. Never point the laser beam at people's eyes.

Safety-related parameters

MTTF_D	326 years (EN ISO 13849-1) ¹⁾
DC_{avg}	0 %
T_M (mission time)	10 years

¹⁾ Mode of calculation: Parts-Count-calculation.

Communication interface

IO-Link	✓, COM2 (38,4 kBaud)
Data transmission rate	COM2 (38,4 kBaud)
Cycle time	2.3 ms
Process data length	16 Bit
Process data structure	Bit 0 = switching signal Q _{L1} Bit 1 = switching signal Q _{L2} Bit 2 ... 15 = measuring value
VendorID	26
DeviceID HEX	0x80010A
DeviceID DEC	8388874

Electronics

Supply voltage U_B	10 V DC ... 30 V DC ¹⁾
Ripple	< 5 V _{pp} ²⁾
Current consumption	30 mA ³⁾
Protection class	III
Digital output	
Type	PNP ⁴⁾ 5)
Switching mode	Light/dark switching ⁴⁾
Output current I _{max.}	≤ 100 mA
Response time	≤ 0.5 ms ⁶⁾
Repeatability (response time)	150 μs ⁷⁾
Switching frequency	1,000 Hz ⁸⁾
Output function	Complementary
Circuit protection	A ⁹⁾

¹⁾ Limit values when operated in short-circuit protected network: max. 8 A.

²⁾ May not fall below or exceed U_y tolerances.

³⁾ Without load.

⁴⁾ Q = light switching.

⁵⁾ Pin 4: This switching output must not be connected to another output.

⁶⁾ Signal transit time with resistive load.

⁷⁾ Valid for Q \ on Pin2, if configured with software.

⁸⁾ With light/dark ratio 1:1.

⁹⁾ A = V_S connections reverse-polarity protected.

¹⁰⁾ B = inputs and output reverse-polarity protected.

¹¹⁾ C = interference suppression.

¹²⁾ With light / dark ratio 1:1, valid for Q \ on Pin2, if configured with software.

	B ¹⁰⁾ C ¹¹⁾
Response time Q/ on Pin 2	300 μs ... 450 μs ^{6) 7)}
Switching frequency Q / to pin 2	1,000 Hz ¹²⁾

1) Limit values when operated in short-circuit protected network: max. 8 A.

2) May not fall below or exceed U_V tolerances.

3) Without load.

4) Q = light switching.

5) Pin 4: This switching output must not be connected to another output.

6) Signal transit time with resistive load.

7) Valid for Q \ on Pin2, if configured with software.

8) With light/dark ratio 1:1.

9) A = V_S connections reverse-polarity protected.

10) B = inputs and output reverse-polarity protected.

11) C = interference suppression.

12) With light / dark ratio 1:1, valid for Q \ on Pin2, if configured with software.

Mechanics

Housing	Rectangular
Design detail	Slim
Dimensions (W x H x D)	12.2 mm x 41.8 mm x 17.3 mm
Connection	Male connector M8, 4-pin
Material	
	Housing Plastic, Novodur
	Front screen Plastic, PMMA
Weight	100 g

Ambient data

Enclosure rating	IP66 IP67
Ambient operating temperature	-10 °C ... +50 °C
Ambient operating temperature extended	-30 °C ... +55 °C ^{1) 2)}
Ambient temperature, storage	-30 °C ... +70 °C
RoHS certificate	✓

1) As of $T_a = 50$ °C, a max. supply voltage $V_{max.} = 24$ V and a max. load current $I_{max.} = 50$ mA is permitted.

2) Operation below $T_u -10$ °C is possible if the sensor is already switched on at $T_u > -10$ °C, then cools down, and the supply voltage is subsequently not switched off. Switching on below $T_u -10$ °C is not permissible.

Smart Task

Smart Task name	Time measurement + debouncing
Logic function	Direct WINDOW
Timer function	Deactivated Switch-on delay Off delay ON and OFF delay

1) SIO Direct: sensor operation in standard I/O mode without IO-Link communication and without using internal sensor logic or time parameters (set to "direct"/"deactivated").

2) SIO Logic: Sensor operation in standard I/O mode without IO-Link communication. Sensor-internal logic or timing parameters plus Automation Functions used.

3) IOL: Sensor operation with full IO-Link communication and usage of logic, timing and Automation Function parameters.

	Impulse (one shot)
Inverter	Yes
Time measurement accuracy	SIO Direct: --- ¹⁾ SIO Logic: - 0,7 ... + 0,7 ms ± 0,5 % of time measurement value ²⁾ IOL: - 0.9 ... + 0.9 ms ± 0.5% of the time measurement ³⁾
Time measurement accuracy (e.g. accuracy for time measurement value = 1 s)	SIO Direct: --- SIO Logic: - 5,7 ... + 5,7 ms IOL: - 5,9 ... + 5,9 ms
Resolution time measuring value	1 ms
Min. Time between two process events (switches)	SIO Direct: --- SIO Logic: 500 µs IOL: 800 µs
Debounce time max.	SIO Direct: --- SIO Logic: 30.000 ms IOL: 30.000 ms
Switching signal	
Switching signal Q _{L1}	Output type (dependant on the adjusted threshold)
Switching signal Q _{L2}	Output type (dependant on the adjusted threshold)
Measuring value	Time measurement value

¹⁾ SIO Direct: sensor operation in standard I/O mode without IO-Link communication and without using internal sensor logic or time parameters (set to "direct"/"deactivated").

²⁾ SIO Logic: Sensor operation in standard I/O mode without IO-Link communication. Sensor-internal logic or timing parameters plus Automation Functions used.

³⁾ IOL: Sensor operation with full IO-Link communication and usage of logic, timing and Automation Function parameters.

Diagnosis

Device status	Yes
----------------------	-----

Certificates

EU declaration of conformity	✓
UK declaration of conformity	✓
ACMA declaration of conformity	✓
Moroccan declaration of conformity	✓
China RoHS	✓
ECOLAB certificate	✓
IO-Link certificate	✓
Laser safety (IEC 60825-1) certificate	✓
Information according to Art. 3 of Data Act (Regulation EU 2023/2854)	✓

Classifications

ECLASS 5.0	27270904
ECLASS 5.1.4	27270904
ECLASS 6.0	27270904
ECLASS 6.2	27270904
ECLASS 7.0	27270904
ECLASS 8.0	27270904
ECLASS 8.1	27270904
ECLASS 9.0	27270904

ECLASS 10.0	27270904
ECLASS 11.0	27270904
ECLASS 12.0	27270903
ETIM 5.0	EC002719
ETIM 6.0	EC002719
ETIM 7.0	EC002719
ETIM 8.0	EC002719
UNSPSC 16.0901	39121528

Connection diagram Cd-367

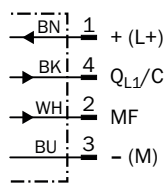

Characteristic curve

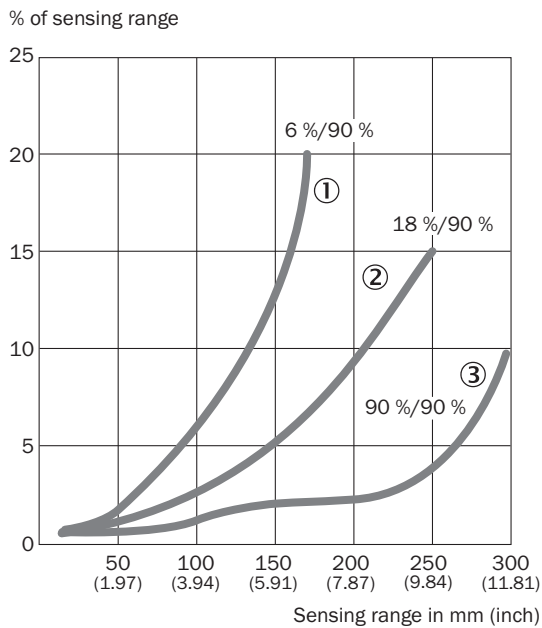

- ① Sensing range on black, 6% remission factor
- ② Sensing range on gray, 18% remission factor
- ③ Sensing range on white, 90% remission factor

Light spot size

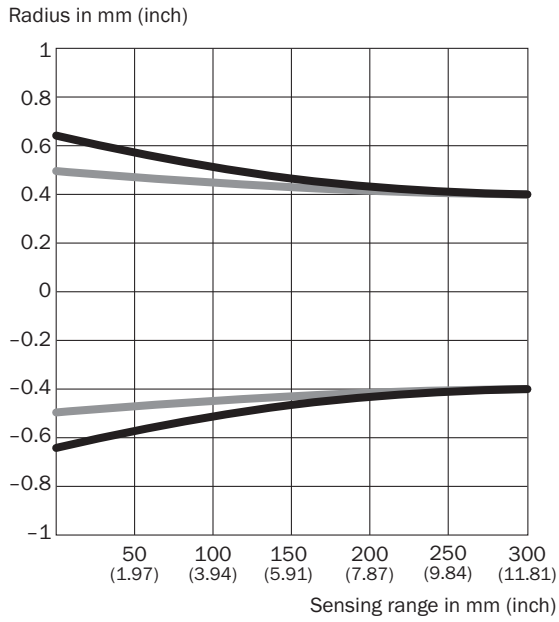

Dimensions in mm (inch)

Sensing range	Vertical	Horizontal
50 mm (1.97)	1.2 (0.05)	1.0 (0.04)
100 mm (3.94)	1.1 (0.04)	1.0 (0.04)
200 mm (7.87)	0.9 (0.04)	0.9 (0.04)
300 mm (11.81)	0.8 (0.03)	0.8 (0.03)

— Vertical
 — Horizontal

Sensing range diagram

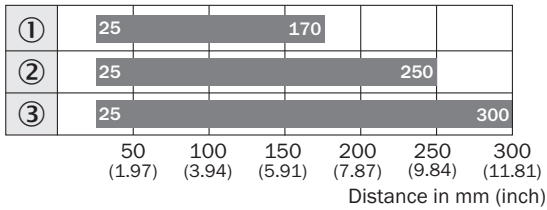

■ Sensing range typ. max.

- ① Sensing range on black, 6% remission factor
- ② Sensing range on gray, 18% remission factor
- ③ Sensing range on white, 90% remission factor

Dimensional drawing

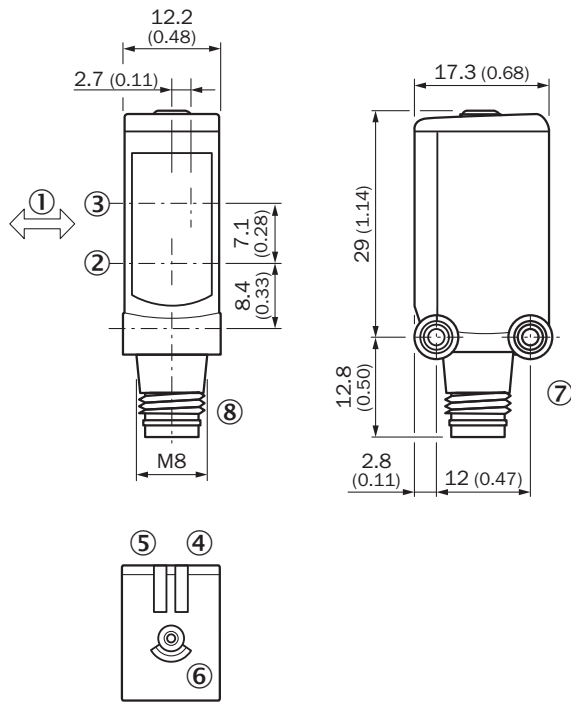



Dimensions in mm (inch)

- ① Standard direction of the material being detected
- ② Center of optical axis, sender
- ③ Center of optical axis, receiver
- ④ LED indicator green: Supply voltage active
- ⑤ LED indicator yellow: Status of received light beam
- ⑥ single teach-in button
- ⑦ Threaded mounting hole M3
- ⑧ Connection

Recommended accessories

Other models and accessories → www.sick.com/W4

	Brief description	Type	part no.
connectors and cables			
	<ul style="list-style-type: none"> Description: Sensor/actuator cable, unshielded Connection type head A: Female connector, M8, 4-pin, straight, A-coded Connection type head B: Flying leads Signal type: Sensor/actuator cable Cable: 5 m, 4-wire, PVC Application: Uncontaminated zones, Zones with chemicals 	YF8U14-050VA3XLEAX	2095889
	<ul style="list-style-type: none"> Description: Unshielded Connection type head A: Male connector, M8, 4-pin, straight, A-coded Connection systems: Screw-type terminals Permitted cross-section: 0.14 mm² ... 0.5 mm² 	STE-0804-G	6037323
	<ul style="list-style-type: none"> Description: Sensor/actuator cable, unshielded Connection type head A: Female connector, M8, 4-pin, straight, A-coded Connection type head B: Flying leads Signal type: Sensor/actuator cable Cable: 5 m, 4-wire, PUR, halogen-free Application: Drag chain operation, Zones with oils and lubricants, Robot, Drag chain operation 	YF8U14-050UA3XLEAX	2094792

SICK AT A GLANCE

SICK is one of the leading manufacturers of intelligent sensors and sensor solutions for industrial applications. A unique range of products and services creates the perfect basis for controlling processes securely and efficiently, protecting individuals from accidents and preventing damage to the environment.

We have extensive experience in a wide range of industries and understand their processes and requirements. With intelligent sensors, we can deliver exactly what our customers need. In application centers in Europe, Asia and North America, system solutions are tested and optimized in accordance with customer specifications. All this makes us a reliable supplier and development partner.

Comprehensive services complete our offering: SICK LifeTime Services provide support throughout the machine life cycle and ensure safety and productivity.

For us, that is “Sensor Intelligence.”

WORLDWIDE PRESENCE:

Contacts and other locations –www.sick.com