



HL18L-P3B5BA

H18 Sure Sense

PHOTOELECTRIC SENSORS

SICK
Sensor Intelligence.



Illustration may differ



Ordering information

Type	part no.
HL18L-P3B5BA	1080745

Other models and accessories → www.sick.com/H18_Sure_Sense

Detailed technical data

Features

Functional principle	Photoelectric retro-reflective sensor
Functional principle detail	With minimum distance to reflector (dual lens system)
Dimensions (W x H x D)	16.2 mm x 45.5 mm x 31.8 mm
Housing design (light emission)	Hybrid
Thread diameter (housing)	M18
Mounting system type	M18, head/side (24.1 ... 25.4 mm)
Housing color	Blue
Sensing range max.	0.1 m ... 12 m ¹⁾
Sensing range	0.1 m ... 10 m ¹⁾
Type of light	Visible red light
Light source	Laser ²⁾ ³⁾
Light spot size (distance)	2 mm (2 m)
Wave length	655 nm
Laser class	I ⁴⁾
Adjustment	
	Potentiometer, right None
	Potentiometer, left None
Special applications	Detecting small objects

¹⁾ Reflector PL80A.

²⁾ Average service life: 50,000 h at T_U = +25 °C.

³⁾ CLASS 1 LASER PRODUCT EN60825-1:2014, IEC60825-1:2014, Maximum pulse power < 2.5 mW, Pulse length: 4 μs, Wavelength: 650 ... 670 nm, Complies with 21 CFR 1040.10 and 1040.11 except for deviations pursuant to Laser Notice No. 50, dated June 24, 2007.

⁴⁾ Do not intentionally look into the laser beam. Never point the laser beam at people's eyes.

Special features	Signal strength light bar
-------------------------	---------------------------

- 1) Reflector PL80A.
- 2) Average service life: 50,000 h at $T_U = +25\text{ °C}$.
- 3) CLASS 1 LASER PRODUCT EN60825-1:2014, IEC60825-1:2014, Maximum pulse power < 2,5 mW, Pulse length: 4 μ s, Wavelength: 650 ... 670 nm, Complies with 21 CFR 1040.10 and 1040.11 except for deviations pursuant to Laser Notice No. 50, dated June 24, 2007.
- 4) Do not intentionally look into the laser beam. Never point the laser beam at people's eyes.

Mechanics/electronics

Supply voltage	10 V DC ... 30 V DC
Ripple	< 5 V _{pp} ¹⁾
Current consumption	≤ 20 mA ²⁾
Switching output	PNP
Output function	Complementary
Switching mode	Light/dark switching
Switching output detail	
Switching output Q1	PNP, Light switching
Switching output Q2	PNP, Dark switching
Output current I_{max.}	≤ 100 mA
Response time	≤ 0.5 ms ³⁾
Switching frequency	1,000 Hz ⁴⁾
Connection type	Cable with M8 male connector, 4-pin, 150 mm
Cable material	Plastic, PVC
Conductor cross section	0.2 mm ²
Circuit protection	A ⁵⁾ B ⁶⁾ D ⁷⁾
Protection class	III
Weight	18 g
Polarizing filter	✓
Housing material	Plastic, VISTAL®
Optics material	Plastic, PMMA
Enclosure rating	IP67 IP69K
Items supplied	Fastening nut (1x), M18, plastic, black, flat
Electromagnetic compatibility (EMC)	EN 60947-5-2 (The sensor complies with the Radio Safety Requirements (EMC) for the industrial sector (Radio Safety Class A). It may cause radio interference if used in a residential area.)
Ambient operating temperature	-30 °C ... +55 °C ⁸⁾

- 1) May not fall below or exceed U_y tolerances.
- 2) Without signal strength light bar and load.
- 3) Signal transit time with resistive load.
- 4) With light/dark ratio 1:1.
- 5) A = V_S connections reverse-polarity protected.
- 6) B = inputs and output reverse-polarity protected.
- 7) D = outputs overcurrent and short-circuit protected.
- 8) Below T_a = -10 °C, sensor must be turned on at T_a > -10 °C. Sensor cannot be turned on below T_a = -10 °C.

Ambient temperature, storage	-40 °C ... +70 °C
UL File No.	E189383

- 1) May not fall below or exceed U_V tolerances.
- 2) Without signal strength light bar and load.
- 3) Signal transit time with resistive load.
- 4) With light/dark ratio 1:1.
- 5) A = V_S connections reverse-polarity protected.
- 6) B = inputs and output reverse-polarity protected.
- 7) D = outputs overcurrent and short-circuit protected.
- 8) Below $T_a = -10$ °C, sensor must be turned on at $T_a > -10$ °C. Sensor cannot be turned on below $T_a = -10$ °C.

Safety-related parameters

MTTF_D	417.2 years
DC_{avg}	0 %

Connection type/pinouts

Connection type	Cable with M8 male connector, 4-pin, 150 mm	
Connection type Detail	Cable material	Plastic
	Conductor cross section	0.2 mm ²
Pinouts	BN 1	+ (L+)
	WH 2	Q ₂
	BU 3	- (M)
	BK 4	Q ₁

Certificates

EU declaration of conformity	✓
UK declaration of conformity	✓
ACMA declaration of conformity	✓
Moroccan declaration of conformity	✓
China RoHS	✓
cULus certificate	✓

Classifications

ECLASS 5.0	27270902
ECLASS 5.1.4	27270902
ECLASS 6.0	27270902
ECLASS 6.2	27270902
ECLASS 7.0	27270902
ECLASS 8.0	27270902
ECLASS 8.1	27270902
ECLASS 9.0	27270902
ECLASS 10.0	27270902
ECLASS 11.0	27270902

ECLASS 12.0	27270902
ETIM 5.0	EC002717
ETIM 6.0	EC002717
ETIM 7.0	EC002717
ETIM 8.0	EC002717
UNSPSC 16.0901	39121528

Dimensional drawing

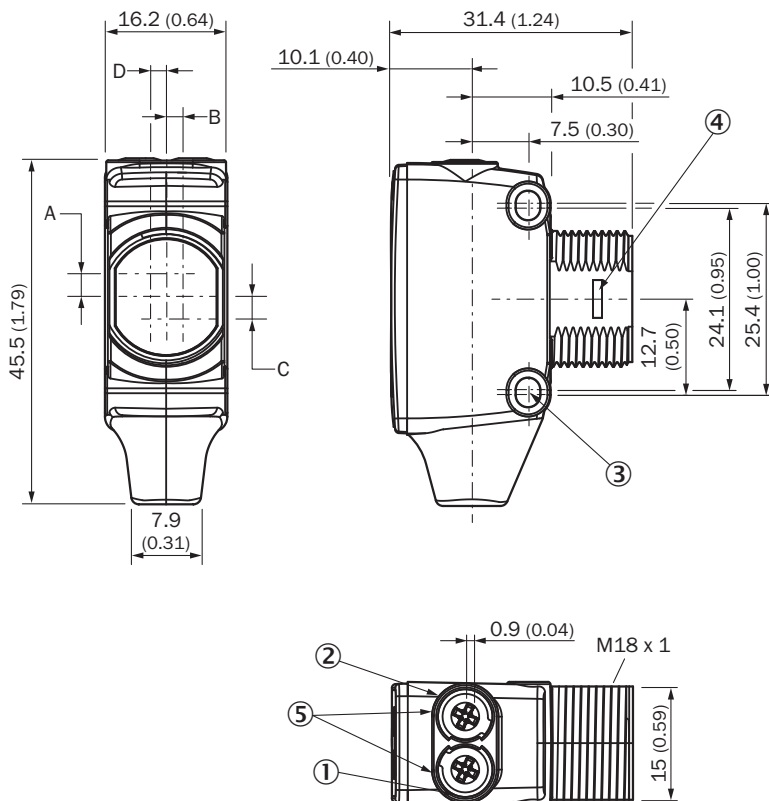

Dimensions in mm (inch)

- ① LED indicator yellow: Status of received light beam
- ② LED indicator green: power on
- ③ M3 mounting hole
- ④ Snap Connection for flush ring (sold seperatly)
- ⑤ Potentiometer (if selected) or LED Indicators

Dimensions in mm (inch)	Receiver		Sender	
	A	B	C	D
-				
HTB18 / HTF18	- 1.1 (0.04)	1.1 (0.04)	4.7 (0.19)	0.6 (0.02)
HTE18 / HL18 / HSE18	2.5 (0.1)	0.0 (0.0)	4.0 (0.16)	0.0 (0.0)
HTB18L / HTF18L / HL18L / HSE18L	2.5 (0.1)	0.0 (0.0)	3.5 (0.14)	0.0 (0.0)

Adjustments

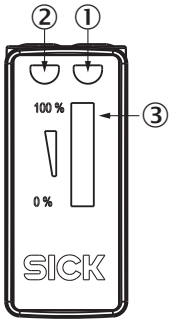

- ① LED indicator yellow: Status of received light beam
- ② LED indicator green: power on
- ③ Signal strength light bar

Pinouts, see table Technical data: Connection type/pinouts

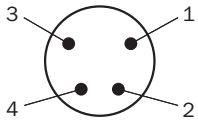

Male connector, M8, 4-pin, uncoded

Characteristic curve

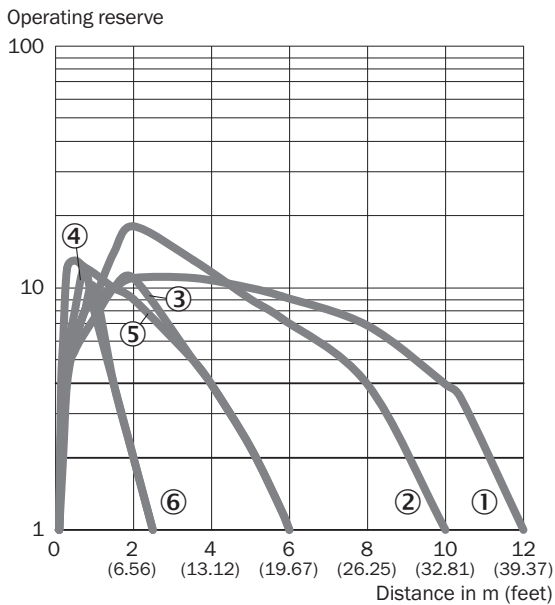

- ① Reflector PL80A
- ② Reflector P250F
- ③ PL10F reflector
- ④ Reflector PL23 FT
- ⑤ Reflective tape REF-AC1000
- ⑥ Reflective tape IREF6000 (REF-IRF-56)

Light spot size



Dimensions in mm (inch)

Sensing range	Vertical	Horizontal
0.2 m (0.57 feet)	1.2 (0.05)	2.65 (0.10)
0.75 m (2.46 feet)	1.8 (0.07)	2.3 (0.09)
5 m (16.40 feet)	4.0 (0.16)	2.2 (0.09)
12 m (39.37 feet)	10.0 (0.39)	5.0 (0.20)

— Vertical
— Horizontal

Sensing range diagram



■ Sensing range ■ Sensing range max.



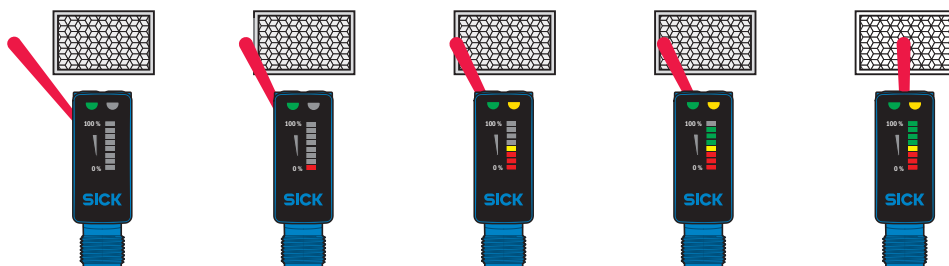

- ① Reflector PL80A
- ② Reflector P250F
- ③ PL10F reflector
- ④ Reflector PL23 FT
- ⑤ Reflective tape REF-AC1000
- ⑥ Reflective tape IREF6000 (REF-IRF-56)



Functions



Recommended accessories

Other models and accessories → www.sick.com/H18_Sure_Sense

	Brief description	Type	part no.
Mounting systems			
	<ul style="list-style-type: none"> Description: Mounting bracket for M18 sensors Material: Steel Details: Steel, zinc coated Items supplied: Without mounting hardware Suitable for: GR18, V180-2, V18, W15, Z1, Z2 	BEF-WN-M18	5308446
	<ul style="list-style-type: none"> Description: Universal mounting bracket for reflectors Dimensions (W x H x L): 85 mm x 90 mm x 35 mm Material: Steel Details: Steel, zinc coated Suitable for: C110A, P250, PL20, PL30A, PL40A, PL80A 	BEF-WN-REFX	2064574
	<ul style="list-style-type: none"> Description: Plate N11N for universal clamp bracket Material: Stainless steel Details: Stainless steel 1.4571 (sheet), Stainless steel 1.4408 (clamp) Items supplied: Universal clamp (5322627), mounting hardware Usable for: DeltaPac, Glare, WTD20E 	BEF-KHS-N11N	2071081
reflectors and optics			
	<ul style="list-style-type: none"> Description: Fine triple reflector, screw connection, suitable for laser sensors Dimensions: 52 mm 62 mm Ambient operating temperature: -30 °C ... +65 °C 	P250F	5308843

	Brief description	Type	part no.
connectors and cables			
	<ul style="list-style-type: none"> Description: Sensor/actuator cable, unshielded Connection type head A: Female connector, M8, 4-pin, straight, A-coded Connection type head B: Flying leads Signal type: Sensor/actuator cable Cable: 5 m, 4-wire, PVC Application: Uncontaminated zones, Zones with chemicals 	YF8U14-050VA3XLEAX	2095889
	<ul style="list-style-type: none"> Description: Unshielded Connection type head A: Male connector, M8, 4-pin, straight, A-coded Connection systems: Screw-type terminals Permitted cross-section: 0.14 mm² ... 0.5 mm² 	STE-0804-G	6037323
	<ul style="list-style-type: none"> Description: Sensor/actuator cable, unshielded Connection type head A: Female connector, M8, 4-pin, straight, A-coded Connection type head B: Flying leads Signal type: Sensor/actuator cable Cable: 5 m, 4-wire, PUR, halogen-free Application: Drag chain operation, Zones with oils and lubricants, Robot, Drag chain operation 	YF8U14-050UA3XLEAX	2094792

SICK AT A GLANCE

SICK is one of the leading manufacturers of intelligent sensors and sensor solutions for industrial applications. A unique range of products and services creates the perfect basis for controlling processes securely and efficiently, protecting individuals from accidents and preventing damage to the environment.

We have extensive experience in a wide range of industries and understand their processes and requirements. With intelligent sensors, we can deliver exactly what our customers need. In application centers in Europe, Asia and North America, system solutions are tested and optimized in accordance with customer specifications. All this makes us a reliable supplier and development partner.

Comprehensive services complete our offering: SICK LifeTime Services provide support throughout the machine life cycle and ensure safety and productivity.

For us, that is “Sensor Intelligence.”

WORLDWIDE PRESENCE:

Contacts and other locations –www.sick.com