



# IMC30-20NPPVC0SA71

IMC

INDUCTIVE PROXIMITY SENSORS

**SICK**  
Sensor Intelligence.



Illustration may differ



### Ordering information

Type	part no.
IMC30-20NPPVCSA71	1079303

**Included in delivery:** BEF-MU-M30N (1)

Other models and accessories → [www.sick.com/IMC](http://www.sick.com/IMC)

### Detailed technical data

#### Features

<b>Housing</b>	Metric
<b>Thread size</b>	M30 x 1.5
<b>Diameter</b>	Ø 30 mm
<b>Sensing range <math>S_n</math></b>	0 mm ... 20 mm <sup>1)</sup>
<b>Safe sensing range <math>S_a</math></b>	16.2 mm
<b>Number of switching points</b>	Up to 4 adjustable switching points or windows
<b>Switching modes</b>	Single point, Window mode, Two point mode, Visual adjustment indicator
<b>Switching frequency Qint.1 / Qint.2 on Pin2</b>	200 Hz
<b>Installation type</b>	Non-flush
<b>Connection type</b>	Male connector M12, 4-pin <sup>2)</sup>
<b>Switching output</b>	PNP
<b>Switching output detail</b>	PNP
<b>Output Q/C</b>	Switching output or IO-Link mode
<b>Output MFC</b>	Switching output or input
<b>Output function</b>	NC / NO
<b>Output characteristic</b>	Programmable
<b>Electrical wiring</b>	DC 4-wire
<b>Enclosure rating</b>	IP68 <sup>3)</sup> IP69K <sup>4)</sup>
<b>Special features</b>	Smart Task, Resistant against coolant lubricants

<sup>1)</sup> Adjustable.

<sup>2)</sup> With gold plated contact pins.

<sup>3)</sup> According to EN 60529.

<sup>4)</sup> According to ISO 20653:2013-03.

<b>Special applications</b>	Zones with coolants and lubricants, Difficult application conditions
<b>Special characteristic</b>	Resistant against coolant lubricants
<b>Pin 2 configuration</b>	External input, Teach-in, switching signal
<b>Items supplied</b>	Mounting nut, V2A stainless steel, with locking teeth (2x)

- 1) Adjustable.  
 2) With gold plated contact pins.  
 3) According to EN 60529.  
 4) According to ISO 20653:2013-03.

### Mechanics/electronics

<b>Supply voltage</b>	10 V DC ... 30 V DC <sup>1)</sup>
<b>Ripple</b>	≤ 10 %
<b>Voltage drop</b>	≤ 2 V <sup>2)</sup>
<b>Hysteresis</b>	Programmable <sup>3)</sup>
<b>Reproducibility</b>	≤ 5 % <sup>4)</sup> 5)
<b>Temperature drift (of S<sub>r</sub>)</b>	± 10 %
<b>EMC</b>	According to EN 60947-5-2
<b>Continuous current I<sub>a</sub></b>	≤ 200 mA <sup>6)</sup>
<b>Short-circuit protection</b>	✓
<b>Power-up pulse protection</b>	✓
<b>Shock and vibration resistance</b>	100 g / 2 ms / 500 cycles; 150 g / 1 Mio cycles; 10 Hz ... 55 Hz / 1 mm; 55 Hz ... 500 Hz / 60 g
<b>Ambient operating temperature</b>	-40 °C ... +75 °C
<b>Housing material</b>	Stainless steel V2A, DIN 1.4305 / AISI 303
<b>Sensing face material</b>	Plastic, LCP
<b>Housing length</b>	70 mm
<b>Thread length</b>	40 mm
<b>Tightening torque, max.</b>	Typ. 100 Nm <sup>7)</sup>
<b>UL File No.</b>	E181493
<b>Teach-in accuracy</b>	+/- 3% of S <sub>r</sub>
<b>Resolution, typical (range)</b>	75 μm (0 mm ... 15 mm) 150 μm (15 mm ... 20 mm)
<b>Resolution, maximum (area)</b>	150 μm (0 mm ... 15 mm) 300 μm (15 mm ... 20 mm)

- 1) IO-Link mode: 18 VDC ... 30 VDC.  
 2) At I<sub>a</sub> max.  
 3) To comply with EN 60947-5-2, a hysteresis of approx. 10% must be set.  
 4) Supply voltage U<sub>B</sub> and constant ambient temperature T<sub>a</sub>.  
 5) Of S<sub>r</sub>.  
 6) 200 mA total for both switching outputs.  
 7) Valid if toothed side of nut is used.

### Safety-related parameters

<b>MTTF<sub>D</sub></b>	688 years
<b>DC<sub>avg</sub></b>	0 %

<b>T<sub>M</sub> (mission time)</b>	20 years
-------------------------------------	----------

### Communication interface

<b>Communication interface</b>	IO-Link V1.1
<b>Communication Interface detail</b>	COM2 (38,4 kBaud)
<b>Cycle time</b>	5 ms
<b>Process data length</b>	32 Bit
<b>Process data structure</b>	Bit 0 = switching signal Q <sub>L1</sub> Bit 1 = switching signal Q <sub>L2</sub> Bit 2 = switching signal Q <sub>Int3</sub> Bit 3 = switching signal Q <sub>Int4</sub> Bit 18 ... 31 = counting value
<b>Factory setting</b>	Switching Point 1: reference value 1 Output: normally open Pin 2 configuration: input

### Reference values

<b>Note</b>	Reference value in Digits for switching point in mm stored in the sensor
<b>Reference value 1</b>	20 mm
<b>Reference value 2</b>	15 mm
<b>Reference value 3</b>	10 mm
<b>Reference value 4</b>	5 mm

### Reduction factors

<b>Stainless steel (V2A, 304)</b>	Approx. 0.8
<b>Aluminum (Al)</b>	Approx. 0.4
<b>Copper (Cu)</b>	Approx. 0.2
<b>Brass (Br)</b>	Approx. 0.4

### Installation note

<b>Remark</b>	Associated graphic see "Installation"
<b>A</b>	20 mm
<b>B</b>	85 mm
<b>C</b>	30 mm
<b>D</b>	60 mm
<b>E</b>	20 mm
<b>F</b>	160 mm

### Smart Task

<b>Smart Task name</b>	Counter + debouncing
<b>Logic function</b>	Window Hysteresis Direct
<b>Timer function</b>	Deactivated Switch-on delay Off delay ON and OFF delay Impulse (one shot)

<sup>1)</sup> SIO Logic: Sensor operation in standard I/O mode without IO-Link communication. Sensor-internal logic or timing parameters plus Automation Functions used.

<sup>2)</sup> IOL: Sensor operation with full IO-Link communication and usage of logic, timing and Automation Function parameters.

<b>Inverter</b>	Adjustable
<b>Maximum counting frequency</b>	SIO Logic: 200 Hz <sup>1)</sup> IOL: 200 Hz <sup>2)</sup>
<b>Counter reset</b>	SIO Logic: 500 µs IOL: —
<b>Debounce time max.</b>	SIO Logic: 30 s <sup>1)</sup> IOL: 30 s <sup>2)</sup>
<b>Switching signal</b>	Switching signal Q <sub>L1</sub> Output type (dependant on the adjusted threshold)
	Switching signal Q <sub>L2</sub> Output type (dependant on the adjusted threshold)
<b>Measuring value</b>	Counting value

<sup>1)</sup> SIO Logic: Sensor operation in standard I/O mode without IO-Link communication. Sensor-internal logic or timing parameters plus Automation Functions used.

<sup>2)</sup> IOL: Sensor operation with full IO-Link communication and usage of logic, timing and Automation Function parameters.

### Certificates

<b>EU declaration of conformity</b>	✓
<b>UK declaration of conformity</b>	✓
<b>ACMA declaration of conformity</b>	✓
<b>Moroccan declaration of conformity</b>	✓
<b>China RoHS</b>	✓
<b>IO-Link certificate</b>	✓
<b>Information according to Art. 3 of Data Act (Regulation EU 2023/2854)</b>	✓

### Classifications

<b>ECLASS 5.0</b>	27270101
<b>ECLASS 5.1.4</b>	27270101
<b>ECLASS 6.0</b>	27270101
<b>ECLASS 6.2</b>	27270101
<b>ECLASS 7.0</b>	27270101
<b>ECLASS 8.0</b>	27270101
<b>ECLASS 8.1</b>	27270101
<b>ECLASS 9.0</b>	27270101
<b>ECLASS 10.0</b>	27270101
<b>ECLASS 11.0</b>	27270101
<b>ECLASS 12.0</b>	27274001
<b>ETIM 5.0</b>	EC002714
<b>ETIM 6.0</b>	EC002714
<b>ETIM 7.0</b>	EC002714
<b>ETIM 8.0</b>	EC002714
<b>UNSPSC 16.0901</b>	39122230

Installation note Non-flush installation

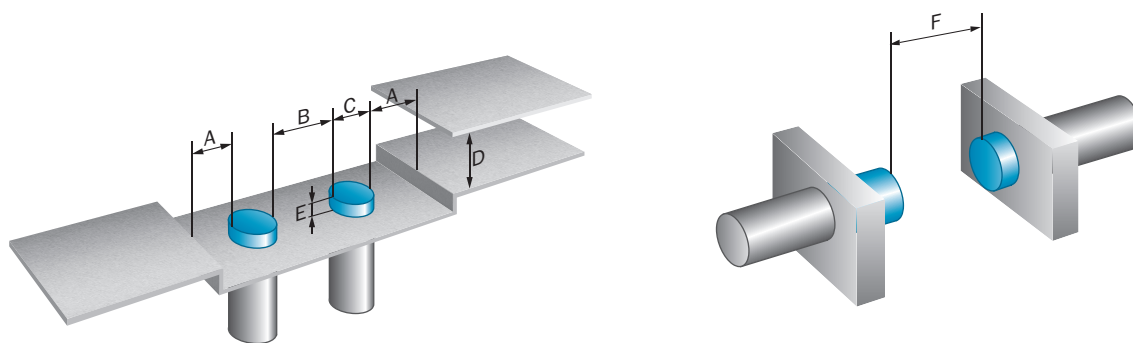

Connection diagram Cd-526

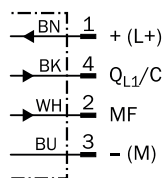

$Q_{L1}/C$  = Switching output,  
 IO-Link communication  
 MF = Multifunction

Response diagram

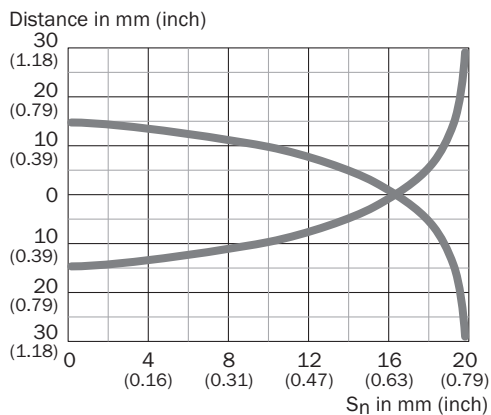



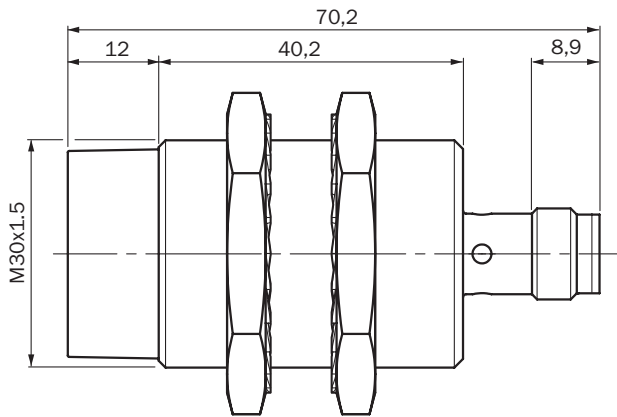

Dimensional drawing IMC30 Standard, connector M12, non-flush



Dimensions in mm (inch)

Recommended accessories

Other models and accessories → [www.sick.com/IMC](http://www.sick.com/IMC)

	Brief description	Type	part no.
integration modules and adapters			
		IOLA2US-01101 (SiLink2 Master)	1061790
Mounting systems			
	<ul style="list-style-type: none"> <li><b>Description:</b> Mounting bracket for M30 sensors</li> <li><b>Material:</b> Steel</li> <li><b>Details:</b> Steel, zinc coated</li> <li><b>Items supplied:</b> Without mounting hardware</li> </ul>	BEF-WN-M30	5308445
	<ul style="list-style-type: none"> <li><b>Description:</b> Mounting plate for M30 sensors</li> <li><b>Material:</b> Steel</li> <li><b>Details:</b> Steel, zinc coated</li> <li><b>Items supplied:</b> Without mounting hardware</li> </ul>	BEF-WG-M30	5321871
	<ul style="list-style-type: none"> <li><b>Description:</b> Plate N10 for universal clamp bracket, M30</li> <li><b>Material:</b> Steel, zinc diecast</li> <li><b>Details:</b> Zinc plated steel (sheet), Zinc die cast (clamping bracket)</li> <li><b>Items supplied:</b> Universal clamp (5322626), mounting hardware</li> <li><b>Usable for:</b> M30 round sensors</li> </ul>	BEF-KHS-N10	2062372

	Brief description	Type	part no.
connectors and cables			
	<ul style="list-style-type: none"> <li><b>Description:</b> Sensor/actuator cable, unshielded</li> <li><b>Connection type head A:</b> Female connector, M12, 4-pin, straight</li> <li><b>Connection type head B:</b> Flying leads</li> <li><b>Signal type:</b> Sensor/actuator cable</li> <li><b>Cable:</b> 2 m, 4-wire, PP</li> <li><b>Connection systems:</b> Flying leads</li> <li><b>Note:</b> This product is generally resistant to chemical cleaning agents (see ECOLAB) and other chemical compounds such as H2O2 and CH2O2. Before permanent installation is carried out, the material's resistance to the cleaning agent being used must be checked., Resistant against lactic acid &amp; hydrogen peroxide (H2O2)</li> <li><b>Application:</b> Hygienic and washdown zones, Drag chain operation, Robot, cold bending resistant, seawater resistant</li> </ul>	DOL-1204-G02MRN	6058291
	<ul style="list-style-type: none"> <li><b>Description:</b> Sensor/actuator cable, unshielded</li> <li><b>Connection type head A:</b> Female connector, M12, 4-pin, straight</li> <li><b>Connection type head B:</b> Flying leads</li> <li><b>Signal type:</b> Sensor/actuator cable</li> <li><b>Cable:</b> 5 m, 4-wire, PP</li> <li><b>Connection systems:</b> Flying leads</li> <li><b>Note:</b> This product is generally resistant to chemical cleaning agents (see ECOLAB) and other chemical compounds such as H2O2 and CH2O2. Before permanent installation is carried out, the material's resistance to the cleaning agent being used must be checked., Resistant against lactic acid &amp; hydrogen peroxide (H2O2)</li> <li><b>Application:</b> Hygienic and washdown zones, Drag chain operation, Robot, cold bending resistant, seawater resistant</li> </ul>	DOL-1204-G05MRN	6058476
	<ul style="list-style-type: none"> <li><b>Description:</b> Sensor/actuator cable, unshielded</li> <li><b>Connection type head A:</b> Female connector, M12, 4-pin, angled</li> <li><b>Connection type head B:</b> Flying leads</li> <li><b>Signal type:</b> Sensor/actuator cable</li> <li><b>Cable:</b> 2 m, 4-wire, PP</li> <li><b>Connection systems:</b> Flying leads</li> <li><b>Note:</b> This product is generally resistant to chemical cleaning agents (see ECOLAB) and other chemical compounds such as H2O2 and CH2O2. Before permanent installation is carried out, the material's resistance to the cleaning agent being used must be checked., Resistant against lactic acid &amp; hydrogen peroxide (H2O2)</li> <li><b>Application:</b> Hygienic and washdown zones, Drag chain operation, Robot, cold bending resistant, seawater resistant</li> </ul>	DOL-1204-W02MRN	6058474
	<ul style="list-style-type: none"> <li><b>Description:</b> Sensor/actuator cable, unshielded</li> <li><b>Connection type head A:</b> Female connector, M12, 4-pin, angled</li> <li><b>Connection type head B:</b> Flying leads</li> <li><b>Signal type:</b> Sensor/actuator cable</li> <li><b>Cable:</b> 5 m, 4-wire, PP</li> <li><b>Connection systems:</b> Flying leads</li> <li><b>Note:</b> This product is generally resistant to chemical cleaning agents (see ECOLAB) and other chemical compounds such as H2O2 and CH2O2. Before permanent installation is carried out, the material's resistance to the cleaning agent being used must be checked., Resistant against lactic acid &amp; hydrogen peroxide (H2O2)</li> <li><b>Application:</b> Hygienic and washdown zones, Drag chain operation, Robot, cold bending resistant, seawater resistant</li> </ul>	DOL-1204-W05MRN	6058477
	<ul style="list-style-type: none"> <li><b>Description:</b> Sensor/actuator cable, unshielded</li> <li><b>Connection type head A:</b> Female connector, M12, 4-pin, angled</li> <li><b>Connection type head B:</b> Flying leads</li> <li><b>Signal type:</b> Sensor/actuator cable</li> <li><b>Cable:</b> 2 m, 4-wire, PP</li> <li><b>Connection systems:</b> Flying leads</li> <li><b>Note:</b> This product is generally resistant to chemical cleaning agents (see ECOLAB) and other chemical compounds such as H2O2 and CH2O2. Before permanent installation is carried out, the material's resistance to the cleaning agent being used must be checked., Resistant against lactic acid &amp; hydrogen peroxide (H2O2), only suitable for PNP sensors</li> <li><b>Application:</b> Hygienic and washdown zones, Drag chain operation, Robot, cold bending resistant, seawater resistant</li> </ul>	DOL-1204-L02MRN	6058482
	<ul style="list-style-type: none"> <li><b>Description:</b> Sensor/actuator cable, unshielded</li> <li><b>Connection type head A:</b> Female connector, M12, 4-pin, angled</li> <li><b>Connection type head B:</b> Flying leads</li> <li><b>Signal type:</b> Sensor/actuator cable</li> <li><b>Cable:</b> 5 m, 4-wire, PP</li> <li><b>Connection systems:</b> Flying leads</li> <li><b>Note:</b> This product is generally resistant to chemical cleaning agents (see ECOLAB) and other chemical compounds such as H2O2 and CH2O2. Before permanent installation is carried out, the material's resistance to the cleaning agent being used must be checked., Resistant against lactic acid &amp; hydrogen peroxide (H2O2), only suitable for PNP sensors</li> </ul>	DOL-1204-L05MRN	6058483

	Brief description	Type	part no.
	<ul style="list-style-type: none"> <li><b>Application:</b> Hygienic and washdown zones, Drag chain operation, Robot, cold bending resistant, seawater resistant</li> </ul>		
	<ul style="list-style-type: none"> <li><b>Description:</b> Sensor/actuator cable, unshielded</li> <li><b>Connection type head A:</b> Female connector, M12, 4-pin, straight</li> <li><b>Connection type head B:</b> Male connector, M12, 4-pin, straight</li> <li><b>Signal type:</b> Sensor/actuator cable</li> <li><b>Cable:</b> 2 m, 4-wire, PP</li> <li><b>Note:</b> This product is generally resistant to chemical cleaning agents (see ECOLAB) and other chemical compounds such as H2O2 and CH2O2. Before permanent installation is carried out, the material's resistance to the cleaning agent being used must be checked., Resistant against lactic acid &amp; hydrogen peroxide (H2O2)</li> <li><b>Application:</b> Hygienic and washdown zones, Drag chain operation, Robot, cold bending resistant, seawater resistant</li> </ul>	DSL-1204-G02MRN	6058499
	<ul style="list-style-type: none"> <li><b>Description:</b> Sensor/actuator cable, unshielded</li> <li><b>Connection type head A:</b> Female connector, M12, 4-pin, straight</li> <li><b>Connection type head B:</b> Male connector, M12, 4-pin, straight</li> <li><b>Signal type:</b> Sensor/actuator cable</li> <li><b>Cable:</b> 5 m, 4-wire, PP</li> <li><b>Note:</b> This product is generally resistant to chemical cleaning agents (see ECOLAB) and other chemical compounds such as H2O2 and CH2O2. Before permanent installation is carried out, the material's resistance to the cleaning agent being used must be checked., Resistant against lactic acid &amp; hydrogen peroxide (H2O2)</li> <li><b>Application:</b> Hygienic and washdown zones, Drag chain operation, Robot, cold bending resistant, seawater resistant</li> </ul>	DSL-1204-G05MRN	6058500
	<ul style="list-style-type: none"> <li><b>Description:</b> Sensor/actuator cable, unshielded</li> <li><b>Connection type head A:</b> Female connector, M12, 4-pin, angled</li> <li><b>Connection type head B:</b> Male connector, M12, 4-pin, straight</li> <li><b>Signal type:</b> Sensor/actuator cable</li> <li><b>Cable:</b> 2 m, 4-wire, PP</li> <li><b>Note:</b> This product is generally resistant to chemical cleaning agents (see ECOLAB) and other chemical compounds such as H2O2 and CH2O2. Before permanent installation is carried out, the material's resistance to the cleaning agent being used must be checked., Resistant against lactic acid &amp; hydrogen peroxide (H2O2)</li> <li><b>Application:</b> Hygienic and washdown zones, Drag chain operation, Robot, cold bending resistant, seawater resistant</li> </ul>	DSL-1204-B02MRN	6058502
	<ul style="list-style-type: none"> <li><b>Description:</b> Sensor/actuator cable, unshielded</li> <li><b>Connection type head A:</b> Female connector, M12, 4-pin, angled</li> <li><b>Connection type head B:</b> Male connector, M12, 4-pin, straight</li> <li><b>Signal type:</b> Sensor/actuator cable</li> <li><b>Cable:</b> 5 m, 4-wire, PP</li> <li><b>Note:</b> This product is generally resistant to chemical cleaning agents (see ECOLAB) and other chemical compounds such as H2O2 and CH2O2. Before permanent installation is carried out, the material's resistance to the cleaning agent being used must be checked., Resistant against lactic acid &amp; hydrogen peroxide (H2O2)</li> <li><b>Application:</b> Hygienic and washdown zones, Drag chain operation, Robot, cold bending resistant, seawater resistant</li> </ul>	DSL-1204-B05MRN	6058503
	<ul style="list-style-type: none"> <li><b>Description:</b> Sensor/actuator cable, unshielded</li> <li><b>Connection type head A:</b> Female connector, M12, 4-pin, straight, A-coded</li> <li><b>Connection type head B:</b> Flying leads</li> <li><b>Signal type:</b> Sensor/actuator cable</li> <li><b>Cable:</b> 5 m, 4-wire, PUR, halogen-free</li> <li><b>Application:</b> Drag chain operation, Zones with oils and lubricants, Robot, Drag chain operation</li> </ul>	YF2A14-050UB3XLEAX	2095608
	<ul style="list-style-type: none"> <li><b>Description:</b> Sensor/actuator cable, unshielded</li> <li><b>Connection type head A:</b> Female connector, M12, 4-pin, straight</li> <li><b>Connection type head B:</b> Male connector, M12, 4-pin, straight</li> <li><b>Signal type:</b> Sensor/actuator cable</li> <li><b>Cable:</b> 20 m, 4-wire, PP</li> <li><b>Note:</b> This product is generally resistant to chemical cleaning agents (see ECOLAB) and other chemical compounds such as H2O2 and CH2O2. Before permanent installation is carried out, the material's resistance to the cleaning agent being used must be checked., Resistant against lactic acid &amp; hydrogen peroxide (H2O2)</li> <li><b>Application:</b> Hygienic and washdown zones, Drag chain operation, Robot, cold bending resistant, seawater resistant</li> </ul>	YF2AP4-020PA2M2AP4	2143765
	<ul style="list-style-type: none"> <li><b>Description:</b> Sensor/actuator cable, unshielded</li> <li><b>Connection type head A:</b> Female connector, M12, 4-pin, straight, A-coded</li> <li><b>Connection type head B:</b> Flying leads</li> <li><b>Signal type:</b> Sensor/actuator cable</li> <li><b>Cable:</b> 5 m, 4-wire, PVC</li> <li><b>Application:</b> Uncontaminated zones, Zones with chemicals</li> </ul>	YF2A14-050VB3XLEAX	2096235
	<ul style="list-style-type: none"> <li><b>Description:</b> Sensor/actuator cable, unshielded</li> <li><b>Connection type head A:</b> Female connector, M12, 4-pin, angled</li> <li><b>Connection type head B:</b> Male connector, M12, 4-pin, straight</li> </ul>	YG2AP4-030PA2M2AP4	2151191

	Brief description	Type	part no.
	<ul style="list-style-type: none"><li>• <b>Signal type:</b> Sensor/actuator cable</li><li>• <b>Cable:</b> 3 m, 4-wire, PP</li><li>• <b>Note:</b> This product is generally resistant to chemical cleaning agents (see ECOLAB) and other chemical compounds such as H2O2 and CH2O2. Before permanent installation is carried out, the material's resistance to the cleaning agent being used must be checked., Resistant against lactic acid &amp; hydrogen peroxide (H2O2)</li><li>• <b>Application:</b> Hygienic and washdown zones, Drag chain operation</li></ul>		

## SICK AT A GLANCE

SICK is one of the leading manufacturers of intelligent sensors and sensor solutions for industrial applications. A unique range of products and services creates the perfect basis for controlling processes securely and efficiently, protecting individuals from accidents and preventing damage to the environment.

We have extensive experience in a wide range of industries and understand their processes and requirements. With intelligent sensors, we can deliver exactly what our customers need. In application centers in Europe, Asia and North America, system solutions are tested and optimized in accordance with customer specifications. All this makes us a reliable supplier and development partner.

Comprehensive services complete our offering: SICK LifeTime Services provide support throughout the machine life cycle and ensure safety and productivity.

For us, that is “Sensor Intelligence.”

## WORLDWIDE PRESENCE:

Contacts and other locations –[www.sick.com](http://www.sick.com)